

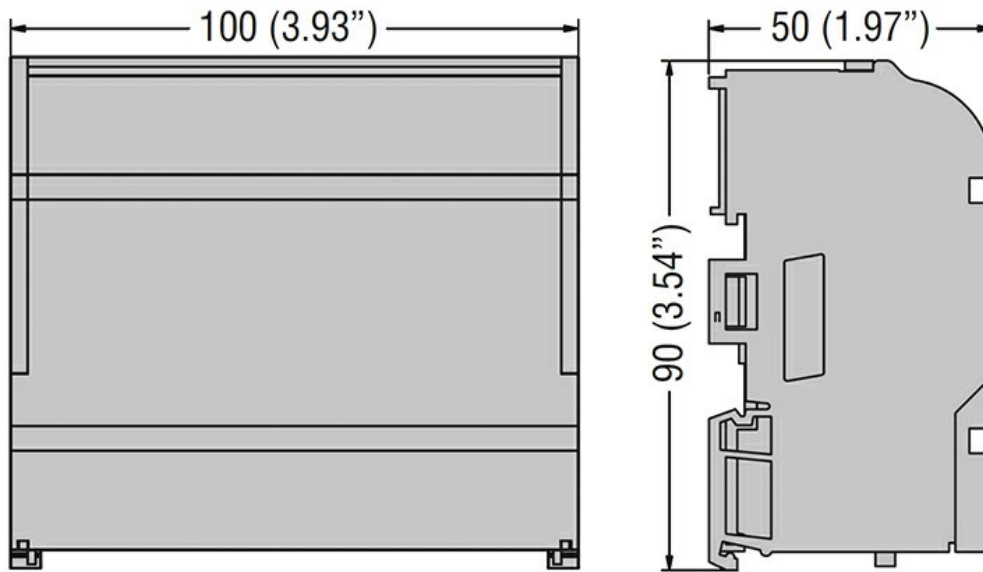

Product designation	Power distribution block	
Electrical features		
Number of poles		4
Rated insulation voltage U_i	V	500
IEC Conventional free air thermal current I_{th}	A	100
Rated peak withstand current I_{pk}	kA	20
Rated short time current I_{cw} 1s	kA	4.5
Connections		
Terminal hole diameter_Option 1	mm	2x8.5mm
Conductor section connectable_Option 1	mm ²	10...25
Tightening torque Max_Option 1	Nm	3
	lbin	27
Terminal hole diameter_Option 2	mm	5x5.5mm
Conductor section connectable_Option 2	mm ²	2.5...6
Tightening torque Max_Option 2	Nm	3
	lbin	27
Terminal hole diameter_Option 3	mm	4x4.5mm
Conductor section connectable_Option 3	mm ²	1.5...4
Tightening torque Max_Option 3	Nm	3
	lbin	27
Mechanical features		
Operating position	normal allowable	Vertical plane Any
Fixing		Screw / DIN rail 35mm
Phillips		2
Weight	g	345
Resistance & Protection		
Terminals IP degree		IP20 front
Dimensions		



Certifications and compliance

Certifications

IEC/EN/BS 60947-7-1

Compliance

TÜV

ETIM classification

EC000066 - Power contactor, AC switching