

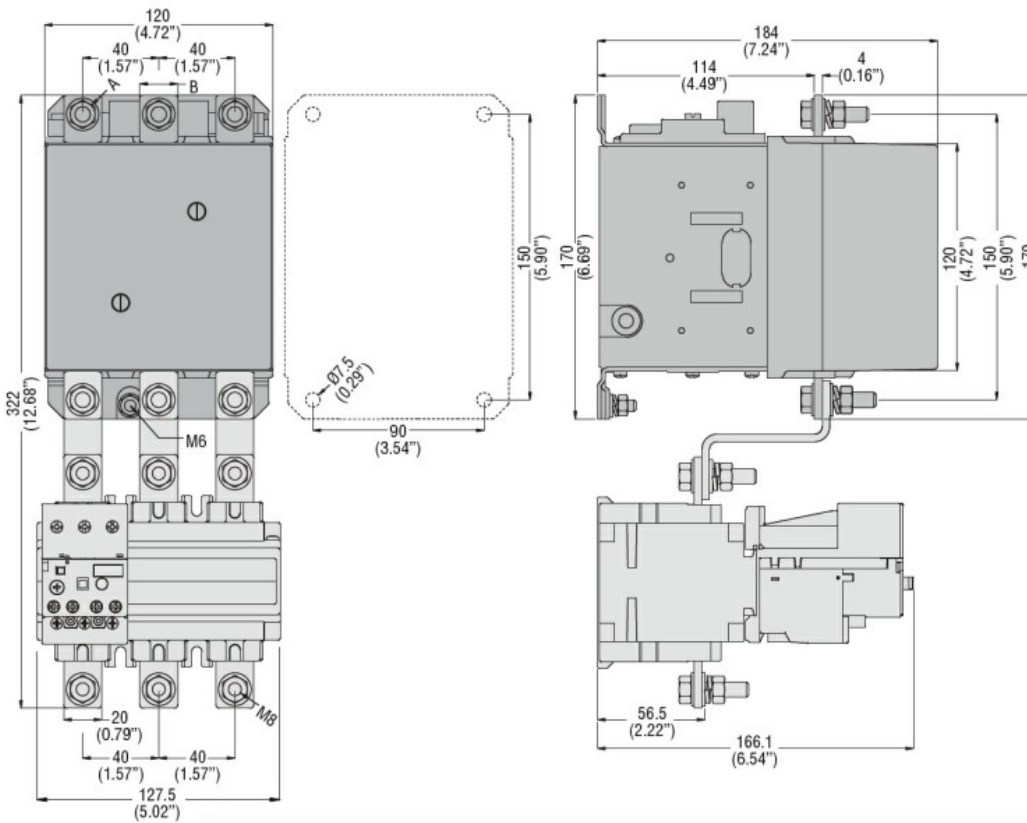

Product designation	RF200		
Product type designation	Motor protection relay		
<b>General characteristics</b>			
Number of poles	Nr.	3	
Overvoltage category	III		
Pollution degree	3		
Frontal IP degree	IP20		
Type of release	Thermal		
Protection fuse			
	gG (IEC)	A	250
	aM (IEC)	A	160
	K5 (UL)	A	500
Phase failure detection	no		
Reset mode	Manual or automatic		
<b>Power circuit characteristics</b>			
Rated insulation voltage $U_i$ IEC/EN	V	1000	
Rated impulse withstand voltage $U_{imp}$	kV	6	
Rated operational voltage	V	690	
Operational frequency			
	min	Hz	50
	max	Hz	60
Operational current $I_e$			
	Operational current min	A	90
	Operational current max	A	150
Tripping class	10A		
Test Button	Yes		
Trip indicator	yes		
Terminals			
	type	screw and flat washer	
	screw	M8	
	width	mm	20
	tool	Bar 13mm	
Tightening torque for terminals			
	min	Nm	18
	max	Nm	18
	min	lbin	13.3
	max	lbin	13.3
<b>Auxiliary circuit characteristics</b>			
Auxiliary contacts			
	NO	Nr.	1
	NC	Nr.	1
Auxiliary Rated insulation voltage $U_i$ IEC/EN	V	690	

Auxiliary Rated impulse withstand voltage Uimp		kV	6
Auxiliary Rated operational voltage		V	690
Operating current AC15	24V	A	3
	120V	A	3
	240V	A	1.5
	380V	A	0.95
	480V	A	0.75
	500V	A	0.72
Operating current DC13	600V	A	0.6
	125V	A	0.11
	600V	A	0.22
IEC Conventional free air thermal current Ith		A	10
<b>Terminals</b>			
	Auxiliary circuit type		screw and washer
	Auxiliary circuit screw		M3,5
	Auxiliary circuit width	mm	8
	Auxiliary circuit tool		Phillips 2
<b>Conductor section</b>			
	Auxiliary circuit Flexible w/o lug max	mm <sup>2</sup>	2.5
	Auxiliary circuit Flexible c/w lug max	mm <sup>2</sup>	2.5
<b>Tightening torque for terminals</b>			
	Auxiliary circuit min	Nm	0.8
	Auxiliary circuit max	Nm	1
	Auxiliary circuit min	lbin	0.59
	Auxiliary circuit max	lbin	0.74
UL/CSA and IEC/EN 60947-5-1 designation			B600-R300
<b>Ambient conditions</b>			
<b>Operating temperature</b>			
	min	°C	-25
	max	°C	60
<b>Storage temperature</b>			
	min	°C	-50
	max	°C	70
<b>Compensation temperature</b>			
	min	°C	-20
	max	°C	60
Max altitude		m	3000
<b>Mechanical features</b>			
<b>Operating position</b>			
	normal allowable		Vertical plan ±30°
Fixing			Screw
Weight		g	2150
<b>UL technical data</b>			
<b>Full-load current (FLA) for three-phase AC motor</b>			
	at 480V	A	150
	at 600V	A	150
<b>Dimensions</b>			



CONTACTOR TYPE	A	B
B115	M6	15 (0.59")
B145	M8	20 (0.79")
B180	M8	20 (0.79")

### Wiring diagrams

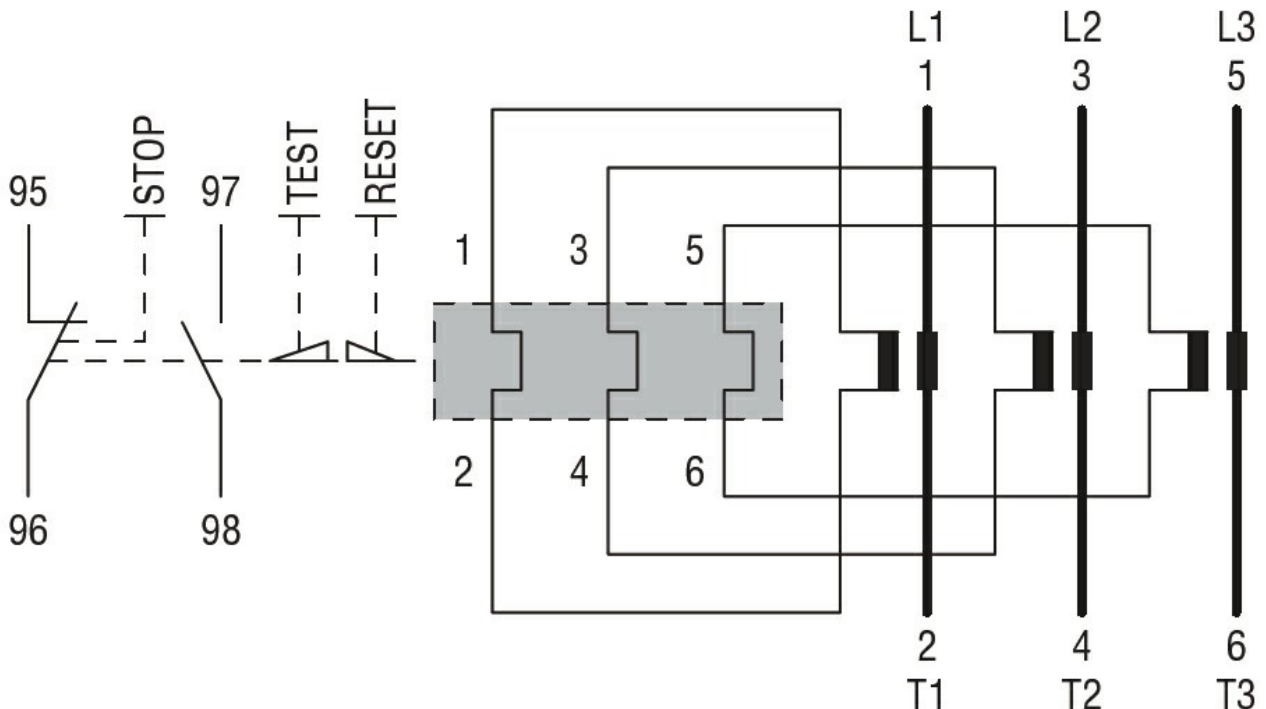

### Certifications and compliance

#### Compliance

CSA C22.2 n° 14

IEC/EN 60947-1

IEC/EN 60947-4-1

UL508

#### Certifications

cULus  
EAC

---

ETIM classification

ETIM 8.0

EC000106 -  
Thermal overload  
relay