



Residual current circuit breakers (RCCB) with overcurrent protection
P1RE
1P+N
2
IEC

Product designation

Product type designation

Number of poles

Number of DIN modules

Compliance

Electrical features

Rated insulation voltage U_i IEC/EN	V	400
Rated impulse withstand voltage U_{imp}	kV	4
Rated operational voltage AC (IEC)	VAC	230
Rated frequency	Hz	50/60
Rated current (I_n)	A	40
Tripping curve		C
Residual operation characteristic		AC
Rated residual current	mA	30
Short circuit rating (IEC)	kA	10
Electrical life	cycles	10000

Ambient conditions

Operating temperature	min	°C	-25
	max	°C	+60
Storage temperature	min	°C	-40
	max	°C	+80
Max altitude	m	2000	

Mechanical features

Operating position	normal	Vertical plan		
		35mm DIN rail		
Fixing				
Tightening torque for terminals	max	Nm	2	
	max	Ibin	15	
Terminals tool		Pz 2		
Conductor section	IEC	min	mm ²	1
		max	mm ²	16
	AWG/Kcmil	min		16
		max		3
Mechanical life		cycles	20000	
Weight		g	205	

Frontal IP degree	IP20
Pollution degree	2

Dimensions

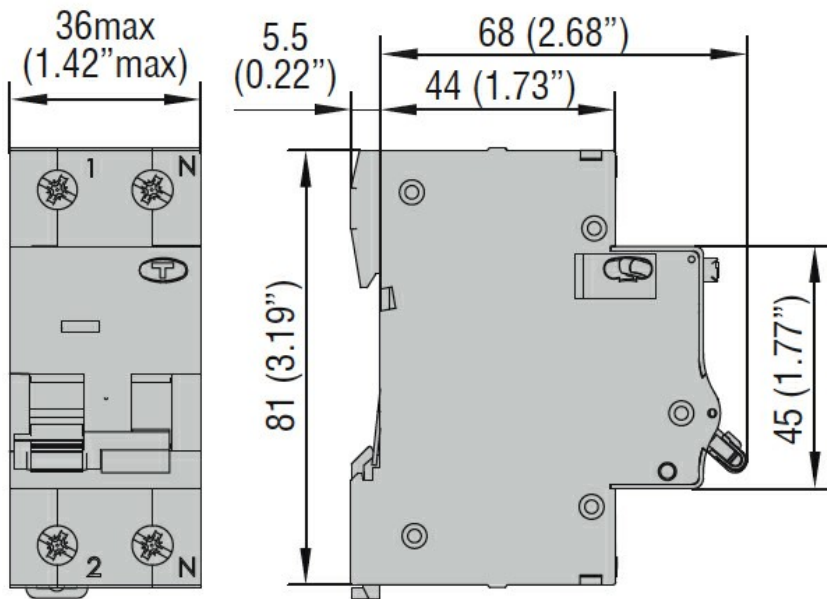

Certifications and compliance

Compliance	IEC/EN/BS 61009-1
------------	-------------------

Certifications	EAC TÜV-SUD
----------------	----------------

ETIM classification

ETIM 8.0	EC000905 - Earth leakage circuit breaker
----------	--