



Residual current circuit breakers (RCCB) with overcurrent protection
P1RE
1P+N
2
IEC

Product designation

Product type designation

Number of poles

Number of DIN modules

Compliance

Electrical features

Rated insulation voltage U_i IEC/EN	V	400
Rated impulse withstand voltage U_{imp}	kV	4
Rated operational voltage AC (IEC)	VAC	230
Rated frequency	Hz	50/60
Rated current (I_n)	A	6
Tripping curve		C
Residual operation characteristic		A
Rated residual current	mA	300
Short circuit rating (IEC)	kA	10
Electrical life	cycles	10000

Ambient conditions

Operating temperature

min	°C	-25
max	°C	+60

Storage temperature

min	°C	-40
max	°C	+80

Max altitude

m 2000

Mechanical features

Operating position

normal Vertical plan

Fixing

35mm DIN rail

Tightening torque for terminals

max	Nm	2
max	lbin	15

Terminals tool

Pz 2

Conductor section

IEC

min	mm ²	1
max	mm ²	16

AWG/Kcmil

min		16
max		3

Mechanical life

cycles 20000

Weight

g 205

Frontal IP degree	IP20
Pollution degree	2

Dimensions

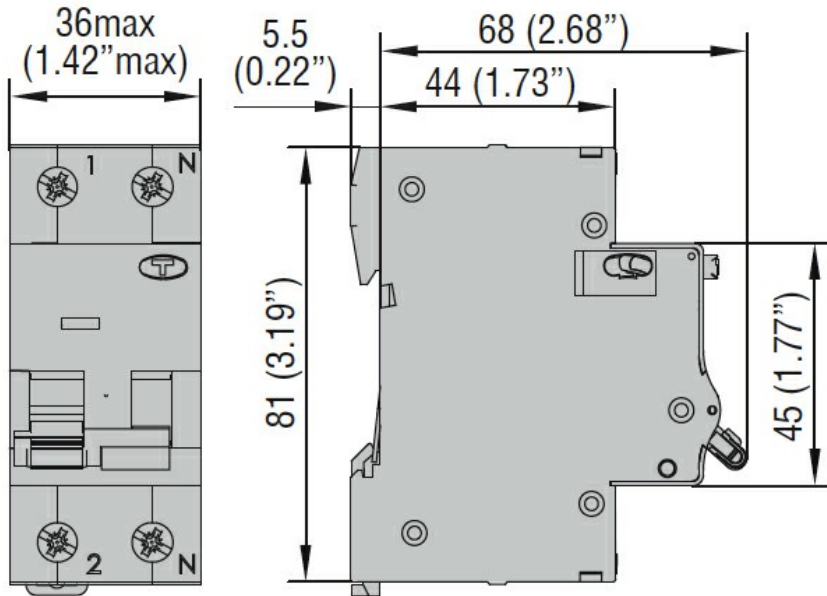

Certifications and compliance

Compliance	IEC/EN/BS 61009-1
------------	-------------------

Certifications	EAC TÜV-SUD
----------------	----------------

ETIM classification

ETIM 8.0	EC000905 - Earth leakage circuit breaker
----------	--