

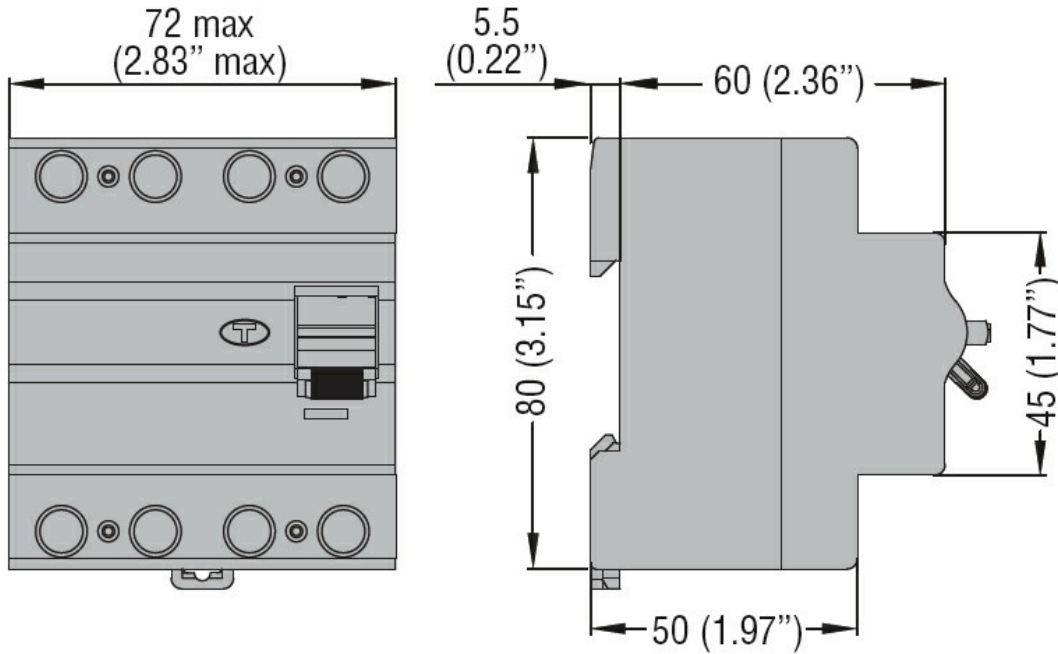

Product designation	Residual current circuit breakers (RCCB)		
Product type designation	P1 RC		
Number of poles	4P		
Number of DIN modules	4		
Compliance	IEC		
Electrical features			
Rated insulation voltage U_i IEC/EN	V	400	
Rated impulse withstand voltage U_{imp}	kV	4	
Rated operational voltage AC (IEC)	VAC	230/400	
Rated frequency	Hz	50/60	
Rated current (I_n)	A	40	
Residual operation characteristic		AC	
Rated residual current	mA	30	
Rated conditional short-circuit current (I_{nc})	kA	10	
Power dissipation per pole max	W	1.2	
Ambient conditions			
Operating temperature	min	°C	-35
	max	°C	+70
Storage temperature	min	°C	-40
	max	°C	80
Max altitude		m	2000
Mechanical features			
Operating position	normal		Vertical plan
			35mm DIN rail
Fixing			
Tightening torque for terminals	min	Nm	1.8
	max	Nm	2
	min	Ibin	16
	max	Ibin	17.7
Terminals tool	Pz 2		
Conductor section	IEC		
	min	mm ²	2.5
	max	mm ²	35
	AWG/Kcmil		
min		14	
max		2	
Weight		g	326
Frontal IP degree	IP20		
Pollution degree	2		

Dimensions



Certifications and compliance

Compliance

IEC/EN/BS 61008-1

Certifications

EAC

TÜV-SUD

ETIM classification

ETIM 8.0

EC000003 -
Residual current
circuit breaker
(RCCB)