

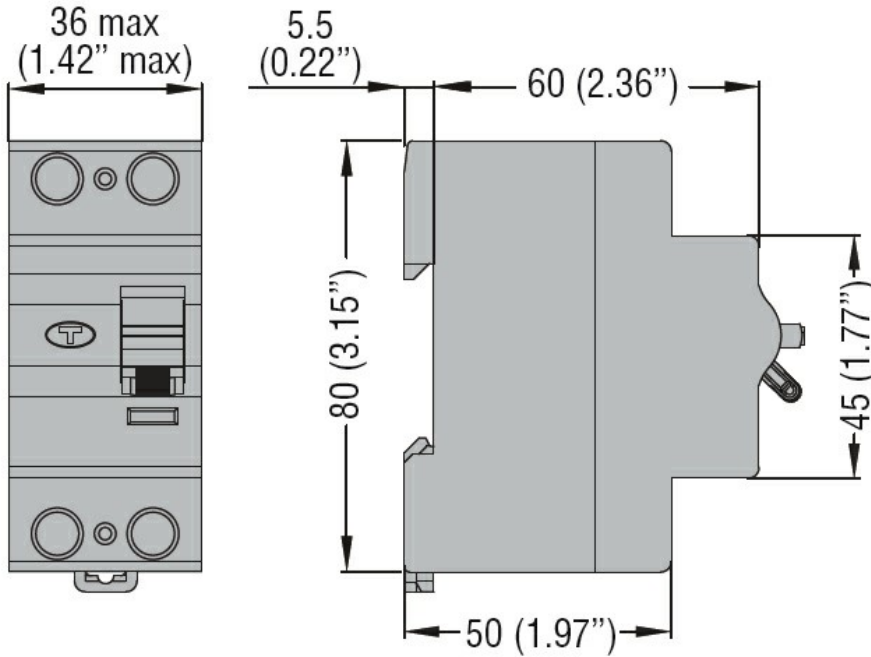

Product designation	Residual current circuit breakers (RCCB)		
Product type designation	P1 RC		
Number of poles	2P		
Number of DIN modules	2		
Compliance	IEC		
<b>Electrical features</b>			
Rated insulation voltage $U_i$ IEC/EN	V	400	
Rated impulse withstand voltage $U_{imp}$	kV	4	
Rated operational voltage AC (IEC)	VAC	230	
Rated frequency	Hz	50/60	
Rated current ( $I_n$ )	A	40	
Residual operation characteristic		AC	
Rated residual current	mA	30	
Rated conditional short-circuit current ( $I_{nc}$ )	kA	10	
Power dissipation per pole max	W	1.6	
<b>Ambient conditions</b>			
Operating temperature	min	°C	-35
	max	°C	+70
Storage temperature	min	°C	-40
	max	°C	80
Max altitude	m	2000	
<b>Mechanical features</b>			
Operating position	normal		Vertical plan
			35mm DIN rail
Fixing			
Tightening torque for terminals	min	Nm	1.8
	max	Nm	2
	min	lbin	16
	max	lbin	17.7
Terminals tool	Pz 2		
Conductor section	IEC		
	min	mm <sup>2</sup>	2.5
	max	mm <sup>2</sup>	35
	AWG/Kcmil		
min		14	
max		2	
Weight	g		185
Frontal IP degree	IP20		
Pollution degree	2		

**Dimensions**



**Certifications and compliance**

Compliance

IEC/EN/BS 61008-1

Certifications

EAC

TÜV-SUD

**ETIM classification**

ETIM 8.0

EC000003 -  
Residual current  
circuit breaker  
(RCCB)