

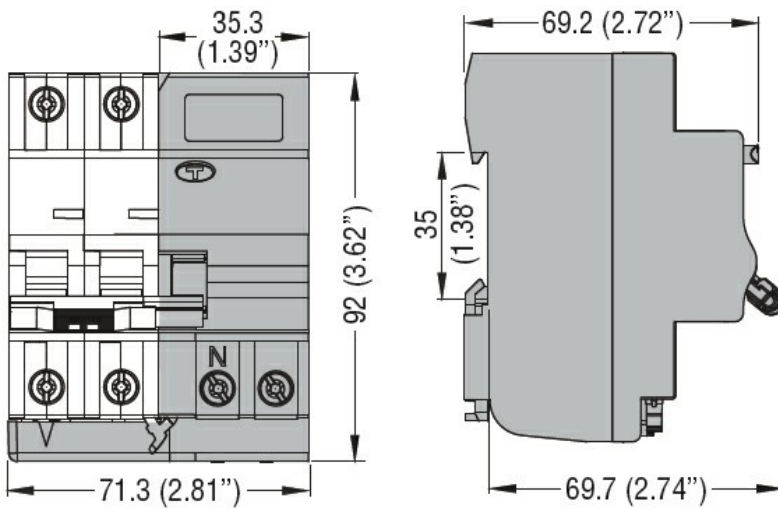

Product designation				Residual block add-on
Product type designation				P1 RA
Number of poles				2P
Number of DIN modules				2
Compliance				IEC
Electrical features				
Rated insulation voltage U_i IEC/EN		V		400
Rated impulse withstand voltage U_{imp}		kV		4
Rated operational voltage AC (IEC)		VAC		230/400
Rated frequency		Hz		50/60
Rated current (I_n)		A		63
Residual operation characteristic				A
Rated residual current		mA		300
Electrical life		cycles		10000
Ambient conditions				
Operating temperature	min	°C		-25
	max	°C		+60
Storage temperature	min	°C		-40
	max	°C		+80
Max altitude		m		2000
Mechanical features				
Operating position		normal		Vertical plan
Fixing				35mm DIN rail
Tightening torque for terminals	min	Nm		1.8
	max	Nm		2
	min	lbin		16
	max	lbin		17.7
Terminals tool				Pz 2
Conductor section	IEC	min	mm ²	1
		max	mm ²	16
	AWG/Kcmil	min		14
		max		6
Mechanical life		cycles		20000
Weight		g		160
Frontal IP degree				IP20
Pollution degree				2

Dimensions



Certifications and compliance

Compliance

IEC/EN 61009-1

Certifications

EAC

TÜV-SUD

ETIM classification

ETIM 8.0

EC002297 -
 Residual current
 circuit breaker
 (RCCB) module