

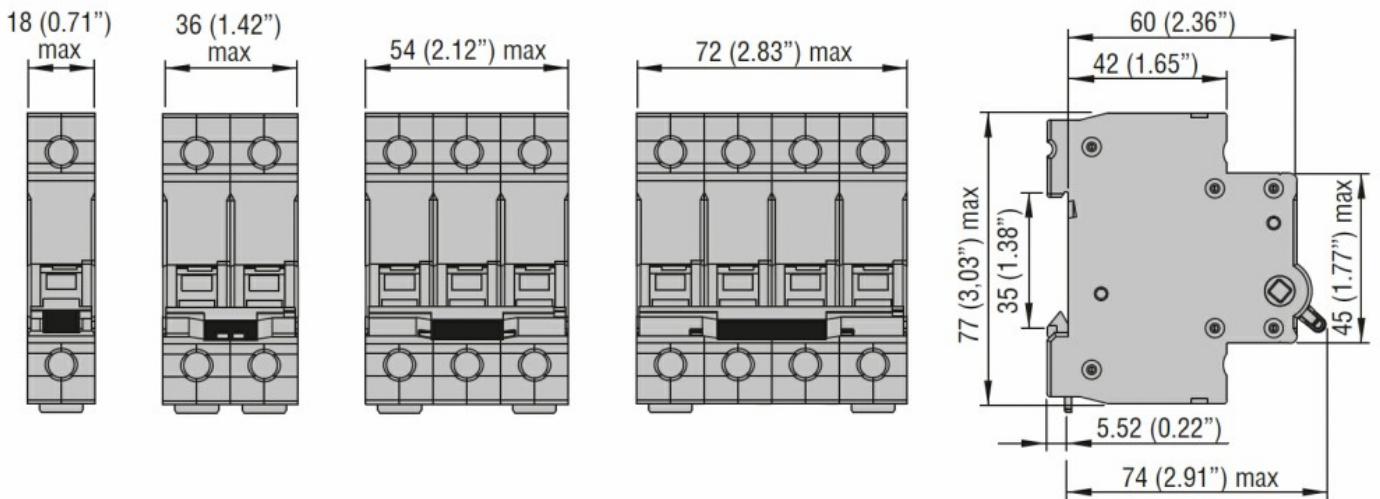

Product designation	Switch disconnecter			
Product type designation	P1MS			
Number of poles	2P			
Number of DIN modules	2			
Compliance	IEC			
Electrical features				
Rated insulation voltage U_i IEC/EN	V	1000		
Rated impulse withstand voltage U_{imp}	kV	4		
Rated operational voltage AC (IEC)	VAC	400...440		
Rated frequency	Hz	50/60		
Rated current (I_n)	A	32		
Short circuit rating (IEC)	kA	25 with gG fuses rated 63A 15 with gG fuses rated 125A		
Electrical life	cycles	1000		
Ambient conditions				
Operating temperature	min	°C	-25	
	max	°C	+70	
Storage temperature	min	°C	-25	
	max	°C	+70	
Max altitude	m	2000		
Mechanical features				
Operating position	normal	Vertical plan		
Fixing		35mm DIN rail		
Tightening torque for terminals	min	Nm	3.2	
	max	Nm	3.5	
	min	lbin	28.3	
	max	lbin	31	
Terminals tool		Pz2		
Conductor section	IEC	min	mm ²	1
		max	mm ²	50
	AWG/Kcmil	min		16
		max		1
Mechanical life	cycles	7000		
Weight	g	170		
Pollution degree		3		
Dimensions				



Wiring diagrams



Certifications and compliance

Compliance

IEC/EN/BS 60947-3.

Certifications

EAC

TÜV-Rheinland

ETIM classification

ETIM 8.0

EC000042 -
Miniature circuit
breaker (MCB)