



Product designation

Roller centre
push lever

Product type designation

KSC2

General characteristics

Material

Housing

Polymer
thermoplastic

Contact characteristics

Type of contact

1NO/NC

Thermal current I_{th}

A 15

IEC/EN 60947-5-1 designation

A600 P300

Rated insulation voltage U_i

V 250

Switching speed

min	m/s	0.01
max	m/s	1

Operating speed

min	m/s	0.05
max	m/s	1

IEC Conventional free air thermal current I_{th}

A 15

Resistance per pole (average value)

mΩ <15

Conductivity

10mA 5V

Mechanical features

Terminals type

Faston

Operating head fixing

Fixed

Operating torque

N	1.3
ozin	4.7

Weight

g 38

Operations

Mechanical life

cycles 20000000

Electrical life

cycles 500000

Mechanical operation

cycles/h 240

Ambient conditions

Temperature

Operating temperature

min	°C	-25
max	°C	+70

Storage temperature

min	°C	-40
max	°C	+70

Resistance & Protection

IP degree

Body housing

IP00 or IP20 with
terminal shroud

Pollution degree

3

Dimensions

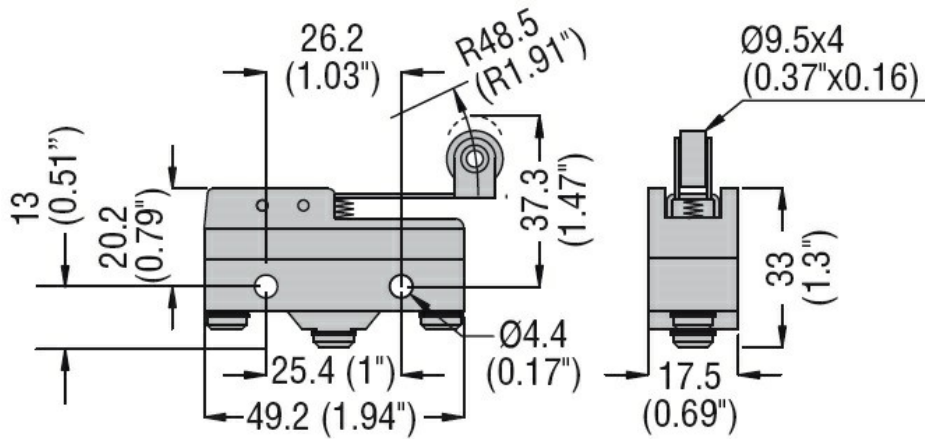

Wiring diagrams

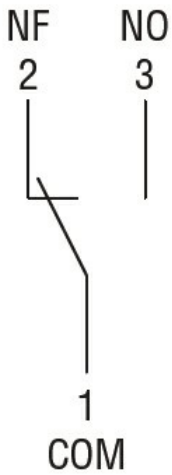

Certifications and compliance

Compliance

CSA C22.2 n° 14.
IEC/EN 60947-1
IEC/EN 60947-5-1
IEC/EN 61058-1
UL508

Certificates

cURus
EAC

ETIM classification

ETIM 8.0

EC000030 - End switch