



One pedal, with safety lever - with cover
KR210

Product designation

Product type designation

General characteristics

Material

Housing

Aluminium-zinc alloy

Contact characteristics

Type of contact

2NO+2NC Snap action

Thermal current I_{th}

A 10

IEC/EN 60947-5-1 designation

A300 Q300

Rated insulation voltage U_i

V 440

Rated impulse withstand voltage U_{imp}

kV 4

Short-circuit protection with fuse

Class/A 10 gG fuse

IEC Conventional free air thermal current I_{th}

A 10

Resistance per pole (average value)

mΩ <10

Mechanical features

Tightening torque (Max)

Contact terminals

Nm 1
lbin 0.74lbf

Cable connection

Self-releasing screw terminal

Cable entry

1 x M20

Operations

Mechanical life

cycles >10000000

Ambient conditions

Temperature

Operating temperature

min °C -25
max °C +70

Storage temperature

min °C -40
max °C +70

Resistance & Protection

IP degree

Terminals IP20
Body housing IP54

Pollution degree

3

Dimensions

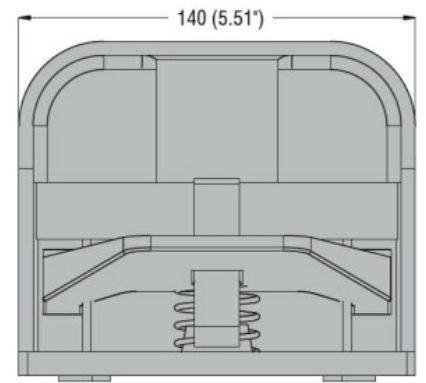
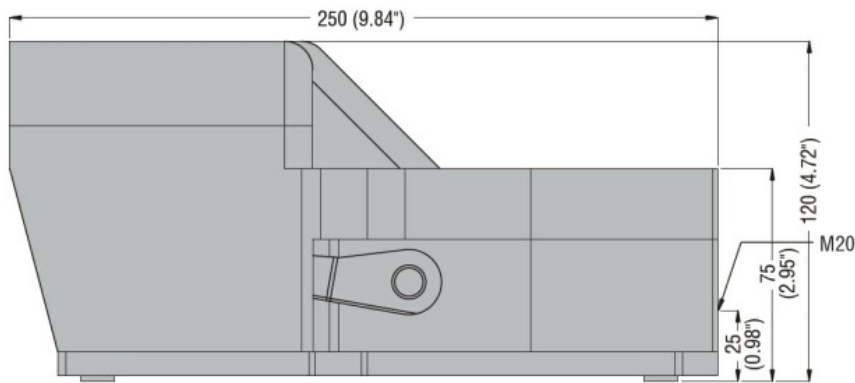

Certifications and compliance

Compliance

EN 60447.

IEC/EN 60204-1

IEC/EN 60947-1

IEC/EN 60947-5-1

Certificates

EAC

ETIM classification

ETIM 8.0

EC001258 - Foot
switch