



Adjustable rod lever
KML

Product designation

Product type designation

General characteristics

Material

Housing	Aluminium-zinc alloy
Rod	Aluminium-zinc alloy

Contact characteristics

Type of contact		3NC Slow action
Thermal current I _{th}	A	10
IEC/EN 60947-5-1 designation		A300 Q300
Rated insulation voltage U _i	V	440
Rated impulse withstand voltage U _{imp}	kV	4
Short-circuit protection with fuse	Class/A	10 gG/SC QUICK FUSE
Switching speed	min	m/s 0.5
	max	m/s 1.5
IEC Conventional free air thermal current I _{th}	A	10
Resistance per pole (average value)	mΩ	<10

Mechanical features

Operating head fixing		Locking bayonet insert	
Operating torque	Ncm	3	
	ozin	4.25	
Tightening torque (Max)	Switch fixing	Nm	2.5
		lbin	22.1
	Contact terminals	Nm	0.8
		lbin	7
Body lid screw fixing	Nm	0.8	
	lbin	7	

Conductor section

AWG/Kcmil	min	16
	max	14
IEC	min	mm ² 1 or 2
	max	mm ² 2.5

Cable connection	Self-releasing screw terminal
Cable entry	M20 on the bottom

Operations

Mechanical life	cycles	<10000000
Mechanical operation	cycles/h	3600

Ambient conditions

Temperature			
Operating temperature			
	min	°C	-25
	max	°C	+70
Storage temperature			
	min	°C	-40
	max	°C	+70

Resistance & Protection

IP degree		Terminals	IP20
		Body housing	IP65
Pollution degree			3

Dimensions

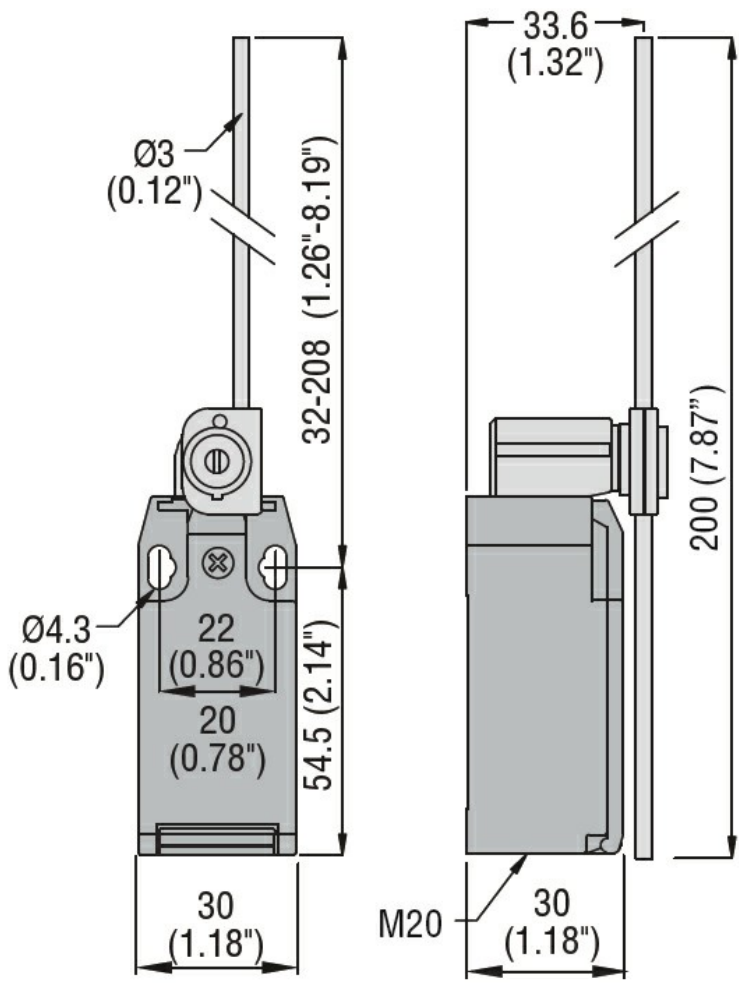

Wiring diagrams

Slow action

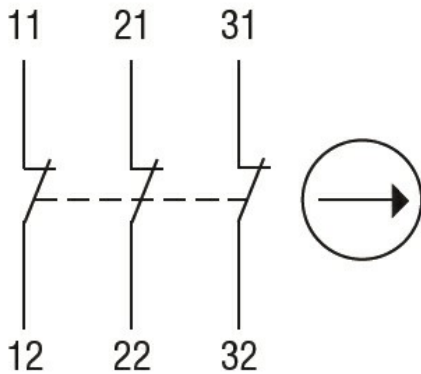

3NC

Certifications and compliance

Compliance

CSA C22.2 n° 14

EN 50047

IEC/EN 60204-1

IEC/EN 60947-1

IEC/EN 60947-5-1

UL508

Certificates

CCC

cULus

EAC

ETIM classification

ETIM 8.0

EC000030 - End
switch