



Product designation

Roller lever
plunger

Product type designation

KBE

General characteristics

Material

Housing

Polymer
thermoplastic
Metal

Roller

Contact characteristics

Type of contact

1NO+1NC Slow
action

Thermal current I_{th}

A

10

IEC/EN 60947-5-1 designation

A600 Q600

Rated insulation voltage U_i

V

690

Rated impulse withstand voltage U_{imp}

kV

6

Insulation class

II

Short-circuit protection with fuse

Class/A

10 gG/SC
QUICK FUSE

Switching speed

min

m/s

0.5

max

m/s

1.5

IEC Conventional free air thermal current I_{th}

A

10

Resistance per pole (average value)

mΩ

<10

Mechanical features

Operating head fixing

Locking bayonet
insert

Operating torque

Ncm

3

ozin

4.25

Tightening torque (Max)

Switch fixing

Nm

2.5

lbin

22.1

Contact terminals

Nm

0.8

lbin

7

Body lid screw fixing

Nm

0.8

lbin

7

Conductor section

AWG/Kcmil

min

16

max

14

IEC

min

mm²

1or 2

max

mm²

2.5

Cable connection	Self-releasing screw terminal
Cable entry	M20 on the bottom

Operations

Mechanical life	cycles	<10000000
Mechanical operation	cycles/h	3600

Ambient conditions

Temperature			
Operating temperature			
	min	°C	-25
	max	°C	+70
Storage temperature			
	min	°C	-40
	max	°C	+70

Resistance & Protection

IP degree	Terminals	IP20
	Body housing	IP65
Pollution degree		3

Dimensions

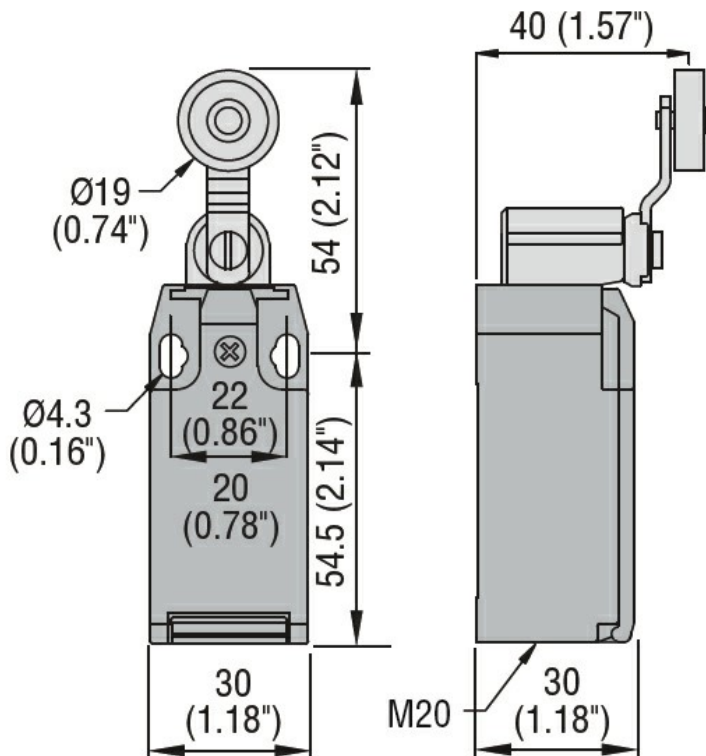

Wiring diagrams

Slow action



Certifications and compliance

Compliance

CSA C22.2 n° 14

EN 50047

IEC/EN 60204-1

IEC/EN 60947-1

IEC/EN 60947-5-1

UL508

Certificates

CCC

cULus

EAC

ETIM classification

ETIM 8.0

EC000030 - End
switch