



Product designation

Roller centre  
push lever

Product type designation

KBC

**General characteristics**

Material

Housing  
Roller

Polymer  
thermoplastic  
Plastic

**Contact characteristics**

Type of contact

1NO+1NC Slow  
action make  
before break

Thermal current I<sub>th</sub>

A 10

IEC/EN 60947-5-1 designation

A600 Q600

Rated insulation voltage U<sub>i</sub>

V 690

Rated impulse withstand voltage U<sub>imp</sub>

kV 6

Insulation class

II

Short-circuit protection with fuse

Class/A 10 gG/SC  
QUICK FUSE

Switching speed

min	m/s	0.5
max	m/s	1.5

IEC Conventional free air thermal current I<sub>th</sub>

A 10

Resistance per pole (average value)

mΩ <10

**Mechanical features**

Operating head fixing

Locking bayonet  
insert

Operating torque

N	6
lb	1.34

Tightening torque (Max)

Switch fixing

Nm	2.5
lbin	22.1

Contact terminals

Nm	0.8
lbin	7

Body lid screw fixing

Nm	0.8
lbin	7

Conductor section

AWG/Kcmil

min	16
max	14

IEC

min	mm <sup>2</sup>	1or 2
-----	-----------------	-------

LIMIT SWITCH, K SERIES, ROLLER CENTRE PUSH LEVER, 1 BOTTOM CABLE ENTRY.  
DIMENSIONS TO EN 50047, PLASTIC BODY, CONTACTS 1NO+1NC SLOW ACTION MAKE  
BEFORE BREAK. PLASTIC ROLLER

	max	mm <sup>2</sup>	2.5
Cable connection			Self-releasing screw terminal
Cable entry			M20 on the bottom

**Operations**

Mechanical life	cycles	<10000000
Mechanical operation	cycles/h	3600

**Ambient conditions**

Temperature	Operating temperature	min	°C	-25
		max	°C	+70
	Storage temperature	min	°C	-40
		max	°C	+70

**Resistance & Protection**

IP degree	Terminals	IP20
	Body housing	IP65
Pollution degree		3

**Dimensions**

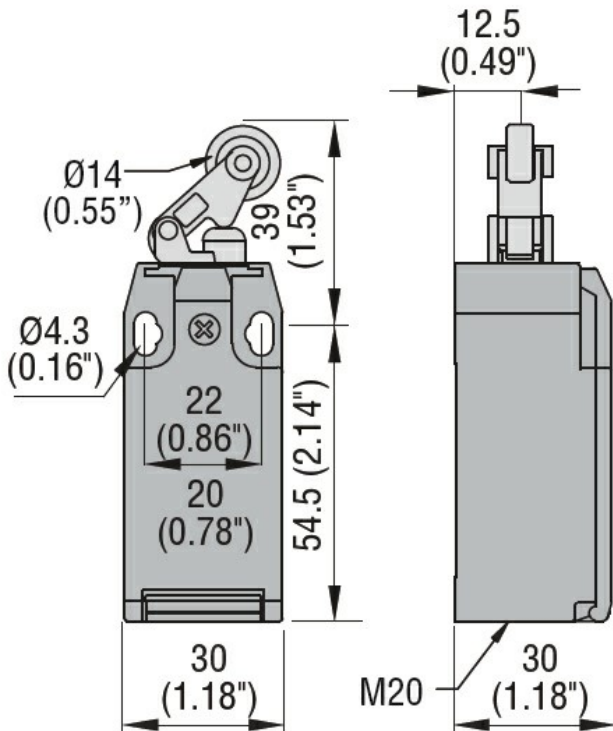

**Wiring diagrams**

## Slow action



**1NO + 1NC**  
**make before break**

### Certifications and compliance

#### Compliance

CSA C22.2 n° 14

EN 50047

IEC/EN 60204-1

IEC/EN 60947-1

IEC/EN 60947-5-1

UL508

#### Certificates

CCC

cULus

EAC

### ETIM classification

ETIM 8.0

EC000030 - End  
switch