



Denumirea produsului
Denumirea tipului de produs

Sonde
CGL125

Conexiuni

Terminale Tip

Tija filetata cu
piulita

Conditii ambientale

Temperatura

Temperatura de Operare

max °C +180

Presiune maximă de lucru

bar 10

Carcasa

Greutate

g 158

Dimensiuni

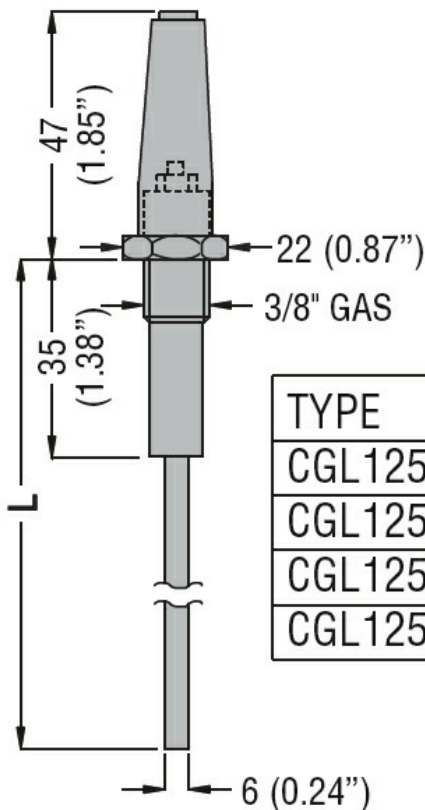

TYPE	L
CGL125 3	327 (12.87")
CGL125 5	500 (19.68")
CGL125 7	700 (27.56")
CGL125 10	1000 (39.37")

Certificari si conformitate

Conformitate

/

Certificate

EAC

Clasificare ETIM

ETIM 8.0

EC010106 -
senzor de nivel al
lichidului