



Product designation  
Product type designation

Probe  
SCM

**Connections**

Terminals type

Threaded rod  
with nut

**Ambient conditions**

Temperature

Operating temperature

max °C +100

Maximum operating pressure

bar 10

**Housing**

Weight

g 115

**Dimensions**

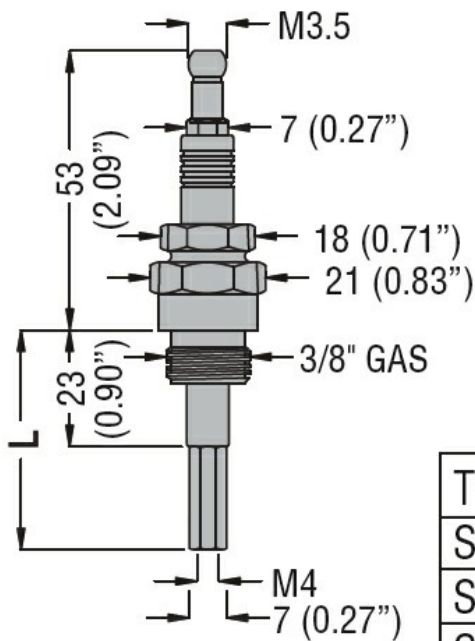

TYPE	L
SCM04	43 (1.69'')
SCM50	500 (19.68'')
SCM100	1000 (39.37'')

**Certifications and compliance**

Compliance

/

Certificates

EAC

**ETIM classification**

ETIM 8.0

EC010106 -  
Liquid level  
sensor