



Product designation
Product type designation

Probe
SCM

Connections

Terminals type

Threaded rod
with nut

Ambient conditions

Temperature

Operating temperature

max °C +100

Maximum operating pressure

bar 10

Housing

Weight

g 162

Dimensions

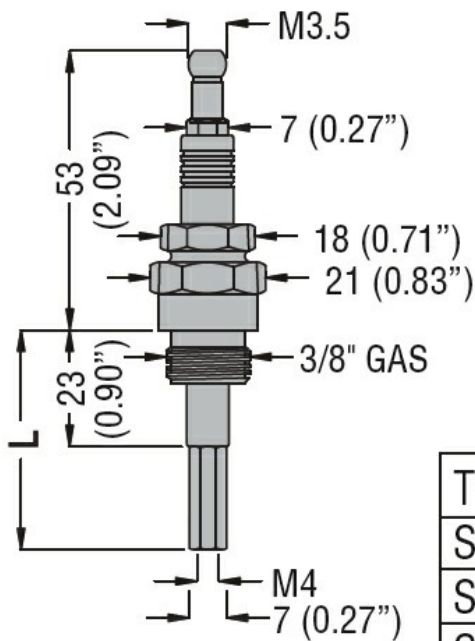

TYPE	L
SCM04	43 (1.69'')
SCM50	500 (19.68'')
SCM100	1000 (39.37'')

Certifications and compliance

Compliance

/

Certificates

EAC

ETIM classification

ETIM 8.0

EC010106 -
Liquid level
sensor