



INDUSTRIAL  
RELAYS ATEX  
HR8020

Product designation

Product type designation

**Contact characteristics**

Contact configuration			2 NO
Rated insulation voltage $U_i$ IEC/EN	V		250
Rated impulse withstand voltage $U_{imp}$	kV		4
IEC Conventional free air thermal current $I_{th}$	A		30
Rated current ( $I_n$ )	A		30
Relay control voltage	V		120VAC
Single-phase motor control		230VAC	kW 2.2
Contact impedance		m $\Omega$	50
Contact material			Ag/SnO <sub>2</sub>

**Operating times**

Closing		ms	25
Opening		ms	25

**Operations**

Mechanical life		cycles	5000000
Electrical life AC1		cycles	100000

**Coil characteristics**

Average coil consumption AC at 20°C		VA	4
-------------------------------------	--	----	---

Operating range

	Closing	% $U_n$	80...110
	Opening	% $U_n$	20...55

Maximum cycle frequency		cycles/h	360
-------------------------	--	----------	-----

**Mechanical features**

Operating position		normal	Any
Fixing			With screw

**Ambient conditions**

Temperature

Operating temperature

min	°C	-40
max	°C	+85

Storage temperature

min	°C	-40
max	°C	+85

**Other features**

Indication		No
Mechanical contact position indicator		No
Mechanical test actuator		No

**Dimensions**

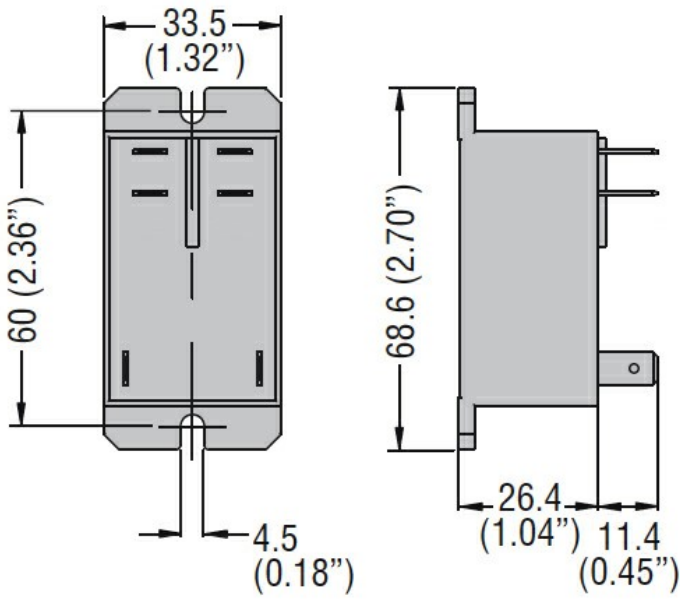

Wiring diagrams

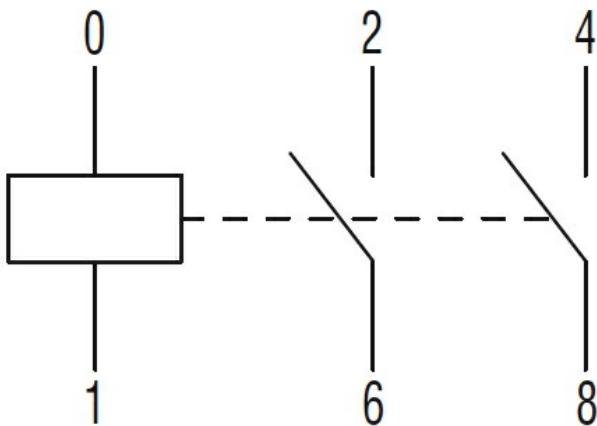

Certifications and compliance

Compliance

IEC/EN/BS 61810-1

Certificates

cURus

EAC

TUV (ATEX)

VDE

ETIM classification

ETIM 8.0

EC001437 –  
 Switching relay