

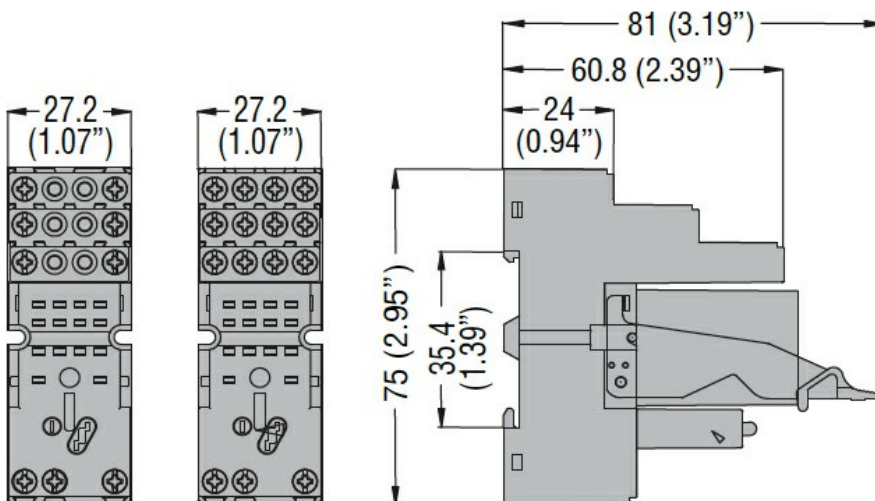

Product designation	SOCKET		
Product type designation	HR6XS42		
Contact characteristics			
Rated insulation voltage U_i IEC/EN	V	250	
Rated impulse withstand voltage U_{imp}	kV	4	
Mechanical features			
Socket screw tightening tool (cross / flat blade)	Phillips 1/4.5mm		
Conductor section			
	AWG/Kcmil	min	20
		max	14
	IEC	min	mm ² 0.5
		max	mm ² 2.5
Fixing	On 35mm DIN rail and with screw		

Dimensions



Wiring diagrams

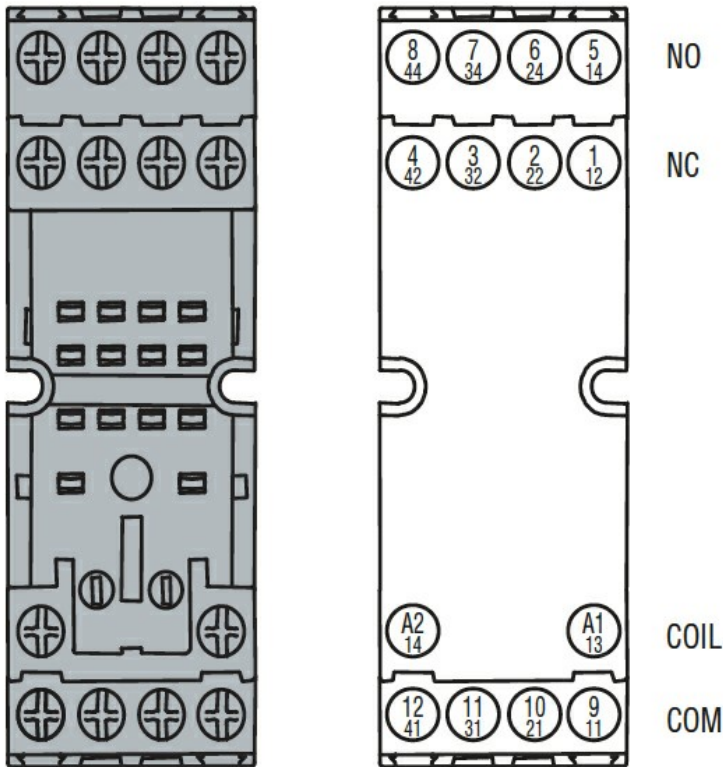

Certifications and compliance

Compliance

IEC/EN 61810

Certificates

CSA

cURus

EAC

ETIM classification

ETIM 8.0

EC001456 -
Relay socket