



Product designation	MINIATURE RELAYS		
Product type designation	HR502C		
Contact characteristics			
Contact configuration	2 C/O		
Rated insulation voltage U_i IEC/EN	V	250	
Rated impulse withstand voltage U_{imp}	kV	6	
IEC Conventional free air thermal current I_{th}	A	8	
Maximum instantaneous current	A	10	
Rated current (I_n)	A	8	
Relay control voltage	V	12VDC	
Max contrrollable power in			
	AC-1	W	2000
	AC-15	VA	150
Rated operating power AC-1		VA	2000
Rated operating power AC-15	230 VAC	VA	150
Rated operating current DC-1			
	30V	A	8
	110V	A	0.3
	220V	A	0.1
Minimum switching load	V / mA	5 / 100	
Contact impedance	m Ω	100	
Contact material	Ag/Ni		
Operating times			
Closing	ms	<15	
Opening	ms	<15	
Operations			
Mechanical life	cycles	10000000	
Electrical life AC1	cycles	50000	
Coil characteristics			
Average coil consumption AC at 20°C	VA	1	
Average coil consumption DC at 20°C	W	0.4	
Operating range			
	Closing	% U_n	75...110
	Opening	% U_n	10...30
Maximum cycle frequency	cycles/h	3600	
Mechanical features			
Max socket terminal tightening torque	Nm	0.6	
Socket screw tightening tool (cross / flat blade)	PH1 / 4.5mm		
Conductor section			
	AWG/Kcmil		
	min	20	
	max	14	

IEC	min	mm ²	0.5
	max	mm ²	2.5
Operating position	normal	Any	
Fixing	On 35mm DIN rail and with screw		

Ambient conditions

Temperature	Operating temperature	min	°C	-40
		max	°C	+70
	Storage temperature	min	°C	-40
		max	°C	+85

Other features

Indication	Yes
Mechanical contact position indicator	Yes
Mechanical test actuator	Yes

Dimensions

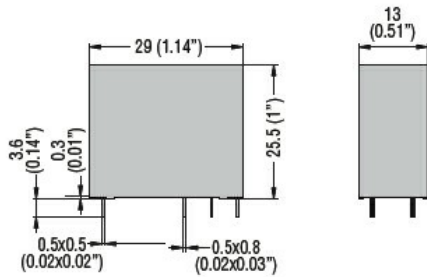

PCB layout

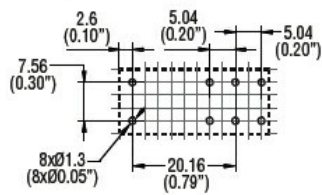

Wiring diagrams

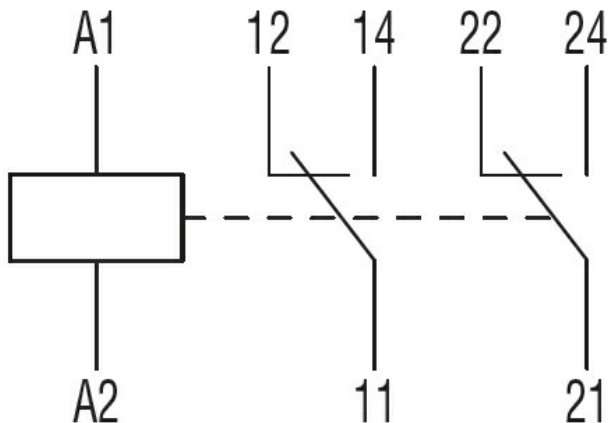

Certifications and compliance

Compliance

IEC/EN 61810

Certificates

CSA

cURus

EAC

VDE

ETIM classification

ETIM 8.0

EC001437 -
Switching relay