



Product designation	Fuse holder		
Product type designation	FB		
Number of DIN modules	1		
Operating voltage type	AC		
<b>Electrical features</b>			
IEC maximum rated current (In)	A	32	
IEC maximum rated voltage (Un)	V	690	
IEC Utilization category	AC22B 500V - AC21B 690V		
Derating factor of rated current In for different ambient temperature			
	20°C	1	
	30°C	0.95	
	40°C	0.9	
	50°C	0.8	
	60°C	0.7	
	70°C	0.5	
Derating factor of rated current In for side by side fuse holders (poles)			
	1-4	1	
	5-6	0.8	
	7-9	0.7	
	≥10	0.6	
Rated current (In)	A	32	
<b>Ambient conditions</b>			
Operating temperature			
	min	°C	-20
	max	°C	+70
Storage temperature			
	min	°C	-40
	max	°C	+80
Max altitude		m	3000
<b>Mechanical features</b>			
Operating position			
	normal allowable	Vertical plan	
		Any	
Fixing	35mm DIN rail		
Tightening torque for terminals			
	max	Nm	2.5
	max	Ibin	22
Conductor section			
	Flexible max (IEC)	mm <sup>2</sup>	16
	- Flexible max (AWG/kcmil)		8
	Rigid max (IEC)	mm <sup>2</sup>	16
	- Rigid max (AWG/kcmil)		8
Weight		g	64
<b>Resistance &amp; Protection</b>			

Frontal IP degree

IP20

Dimensions

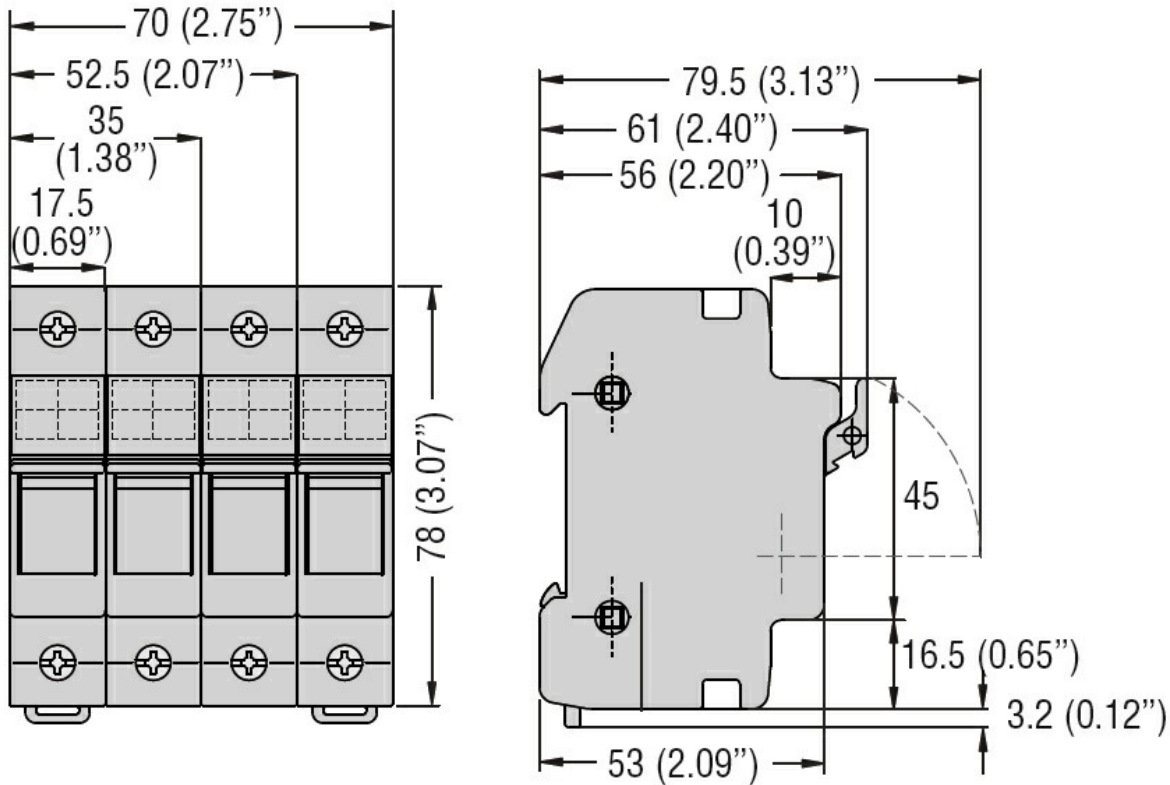

Wiring diagrams



Certifications and compliance

Compliance

IEC/EN 60269-1  
IEC/EN 6069-2  
IEC/EN 60947-1  
IEC/EN 60947-3

Certifications

EAC

ETIM classification

ETIM 8.0

EC002705 -  
Holder for  
cylindrical fuse