



Expansion modules for flush-mount products - input/output EXP1002

Product designation

Product type designation

General characteristics

Description

2 digital inputs and 2 static outputs, opto-isolated

Functions

Inputs and outputs

Compatibility with LOVATO Electric product

Digital multimeters

DMG600/601/611

Yes

Digital power analyzers

DMG7000
DMG7500
DMG8000
DMG9000

Yes
Yes
Yes
Yes

Automatic power factor controllers

DCRG8

Yes

Automatic transfer switch controllers

ATL610
ATL800/900

Yes
Yes

Fire pump controllers

FFLRA400

Yes

Engine and generator controllers

RGK750/RGK8/RGK9

Yes

Input and Output

Digital inputs

Number of digital input	Nr.	2
-------------------------	-----	---

Analog outputs

Number of analog output	Nr.	2
-------------------------	-----	---

Mechanical features

Weight

g 58

Dimensions

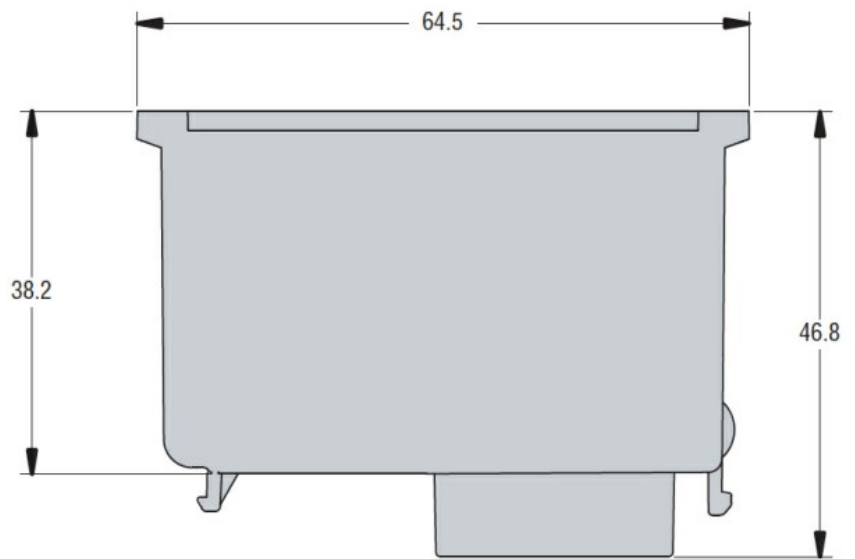
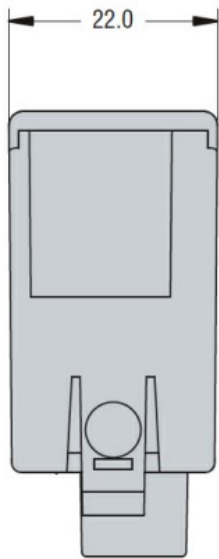

Wiring diagrams

Disposizione morsetti degli ingressi digitali
Terminal arrangement of digital inputs

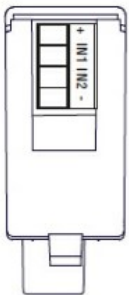

Ingresso da sensori alimentati (vedi note sotto)
Supplied sensor inputs (See note below)

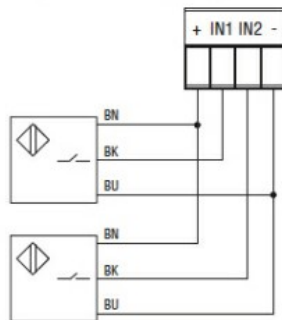

Ingressi da contatto non tensionato
Free voltage contact inputs

Connessione PNP
PNP connection

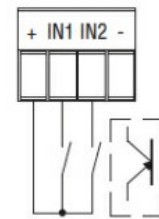

Connessione NPN
NPN connection

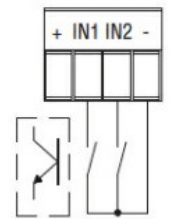

Disposizione morsetti delle uscite (statiche o relè)
Terminal arrangement of outputs (static or relay)

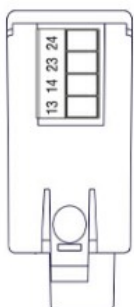

Connessione uscite
Output connections

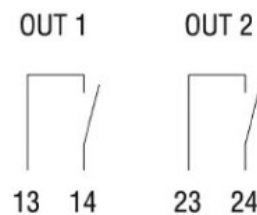

Certifications and compliance

Compliance

- CSA C22.2 n° 14
- IEC/EN 61000-6-2
- IEC/EN 61000-6-3
- IEC/EN 61010-1
- UL508

Certificates

cULus

EAC

ETIM classification

ETIM 8.0

EC002498 -
Accessories/spare
parts for low-
voltage switch
technology