



Automatic mains failure gen-set controllers  
RGK610

Product designation

Product type designation

**Power supply**

Rated battery voltage V 12/24VDC

**Digital inputs**

Digital input type 4 neg.+ 1 pos.

**"W"/AC/PICK-UP speed inputs**

"W"/AC/PICK-UP speed input type "W" or "Pick-up"

**Voltage inputs**

Rated voltage (Ue) VAC 100...480

Measurement range V 100...480

Frequency range Hz 45...65

Measurement method TRMS

**Current inputs**

Rated current (Ie) A 5A/1A

Measurement range 0.05...6A or 0.05...1.2A

Amperometric inputs type 3PH, /5A or /1A

Measurement method TRMS

**Static Outputs**

Static output type 6 (SSR)

**Ambient conditions**

Protection degree

IP40, IP65 with optional gasket seal

**Dimensions**

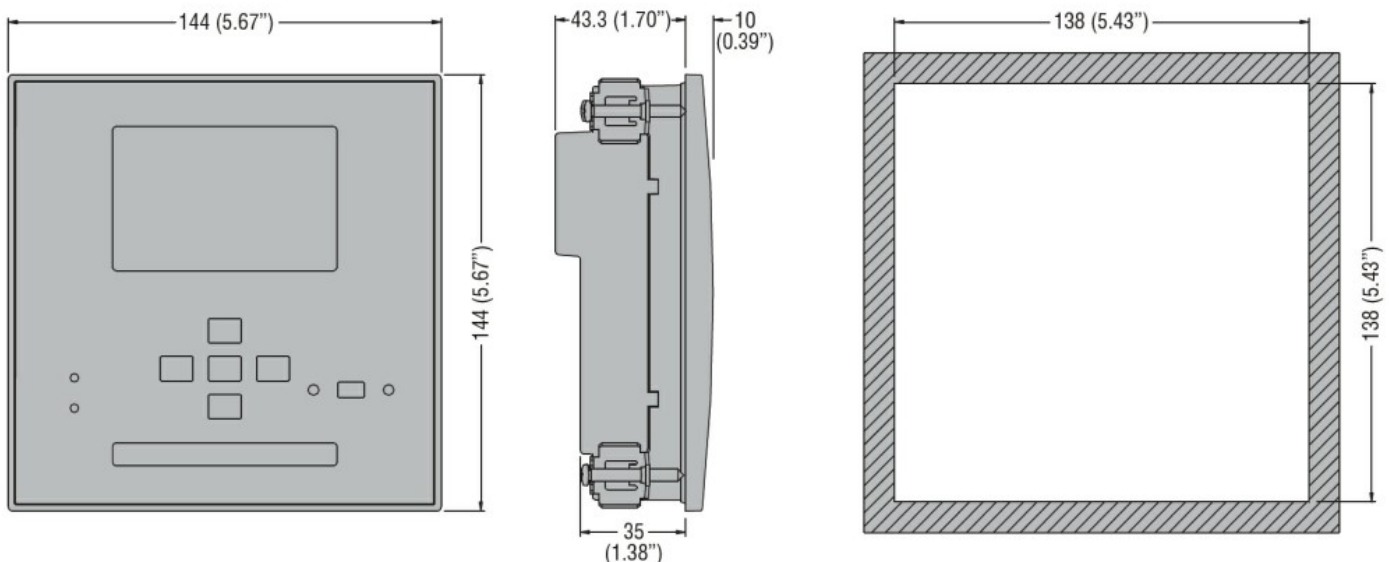

**Wiring diagrams**

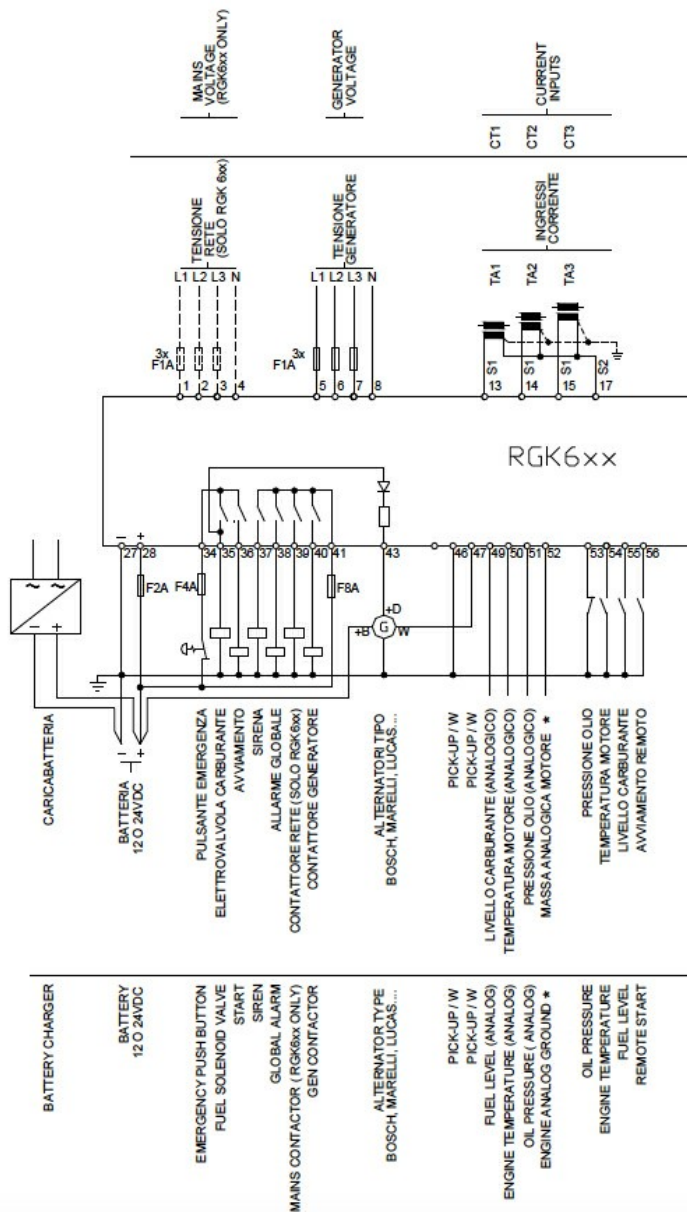

**Certifications and compliance**

**Compliance**

CSA C22.2 n° 14

IEC/EN 61000-6-2

IEC/EN 61000-6-3

IEC/EN 61010-1

UL 508

**Certificates**

EAC

UL Listed for USA and Canada (cULus-File E93601)

**ETIM classification**

ETIM 8.0

EC002758 -  
Energy  
management  
controller