



Multimetre LCD
cu panou.
Extensibil
DMG615
Trifazat + neutru

Denumirea produsului

Denumirea tipului de produs

Tip

Sursa auxiliara US

Tensiune nominală auxiliară de alimentare AC	VAC	100...440
Tensiune nominală auxiliară de alimentare DC	VDC	120...250

Domeniul tensiunii auxiliare de operare

AC

min	VAC	90
max	VAC	484

DC

min	VDC	93.5
max	VDC	300

Frecvența operațională

min	Hz	45
max	Hz	66

Consumul de energie

max	VA	9.5
-----	----	-----

Putere disipată Max

W	3.5
---	-----

Măsurarea intrărilor de tensiune

Tensiune nominală (Ue)

fază-fază	VAC	600
fază neutră	VAC	300

Gama de tensiune de operare

fază-fază	VAC	50...720
fază neutră	VAC	30...360

Frecvența de funcționare a intrărilor de tensiune

min	Hz	45
max	Hz	66

Metoda de măsurare a intrărilor de tensiune

True RMS

Metoda de conectare

Linii monofazate,
bifazate, trifazate
și trifazate
echilibrate

Intrări de curent

Curent nominal (Ie)	A	1A/5A
Domeniu de măsurare		0.025...6A
Metoda de măsurare		TRMS

Capacitate de suprasarcină

+20% Ie prin CT
extern cu
secundar 5A

Vârf de suprasarcină

A	50A pentru 1s
---	---------------

Precizie

Tensiune VLN	±0.2%
--------------	-------

Tensiune VLL	±0.2%
Actual	±0.2%
Frecvență	±0.05%
Putere activă	±0.5%
Energie activa	Class 0.5s (IEC/EN 62053-22)
Energia reactivă	Clasa 2 (IEC/EN 62053-23)

Izolații

Tensiune nominală de izolație Ui IEC/EN	V	600
Tensiune nominală de rezistență la impuls Uimp	kV	9.5
Tensiunea de rezistență a frecvenței de operare	kV	5.2

Funcții

Analiza armonică	Ordinul al 15-lea
Logica PLC	Nu
Tip de port de comunicație	RS485
Funcția gateway Ethernet-RS485	Nu

Caracteristici mecanice

Tip de locuință	Poliamidă
Terminale Tip	Amovibil
Secțiunea transversală a conductorului	

IEC min	mm ²	0.2
IEC max	mm ²	2.5
AWG/Kcmil min	AWG	24
AWG/Kcmil max	AWG	12

Cuplu de strângere (Max)

Nm	0.5
lbin	4.5

Fixare	Incorporat
--------	------------

Greutate	g	350
----------	---	-----

Conditii ambientale

Temperatura

Temperatura de Operare

min	°C	-20
max	°C	+60

Temperatura de depozitare

min	°C	-30
max	°C	+80

Umiditate relativă	%	<90
--------------------	---	-----

Gradul maxim de poluare	2
-------------------------	---

Grad de protecție	IP54
-------------------	------

Dimensiuni

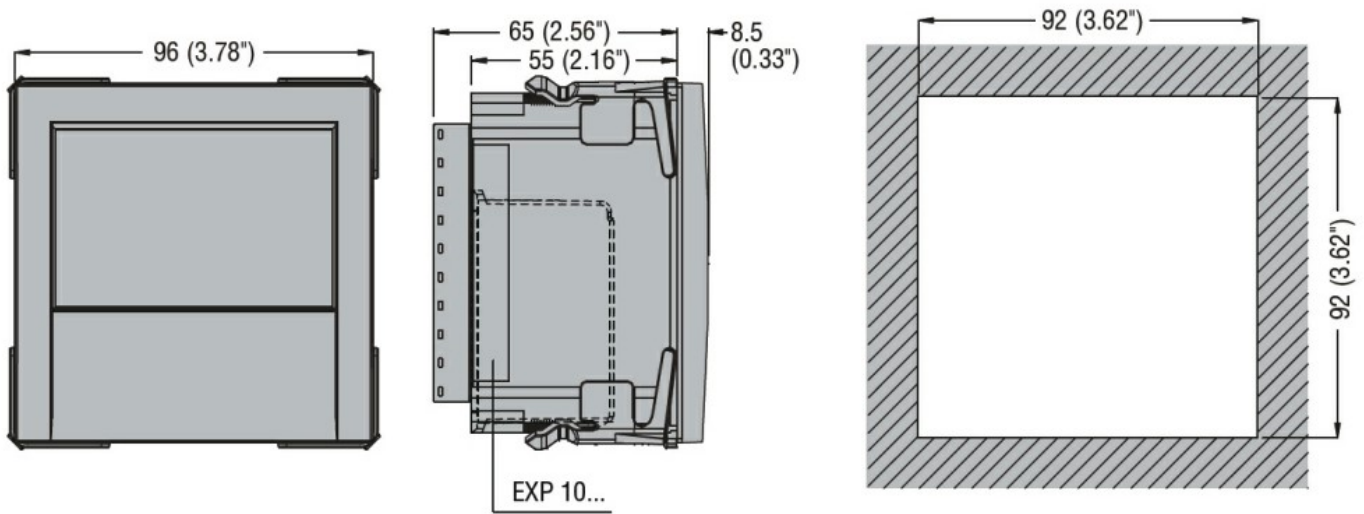

Diagrame de cablare

Single-phase

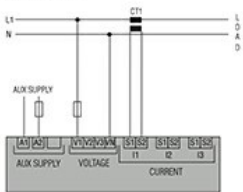

Two-phase

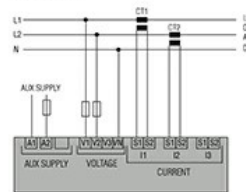

Three-phase with or without neutral

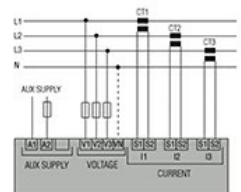

Three-phase without neutral in ARON connection

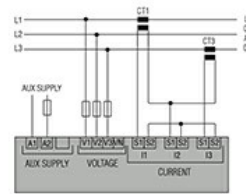
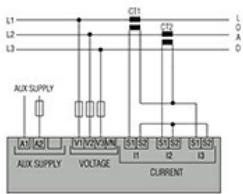

Balanced 3-phase connection with or without neutral

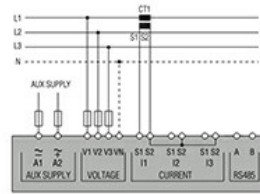

CODE	AUX SUPPLY
DMG100-110-200-210-300	100...240VAC 110...250VDC
DMG6...	100...440VAC 110...250VDC
DMG7000-7500-8000-9000	100...240VAC 110...250VDC



Certificari si conformitate

Conformitate

IEC/EN 61000-6-2

IEC/EN 61000-6-3

IEC/EN 61010-1

IEC/EN 61010-2-030

Certificate

cULus

Clasificare ETIM

ETIM 8.0

EC002301 -
Instrument de
măsură
multifuncțional