



Denumirea produsului	Contoare de energie trifazate DMED332MID		
Denumirea tipului de produs	Trifazat + neutru		
Tip	4		
Numărul modulului șină DIN	4		
<b>Sursa auxiliara US</b>			
Frecvența operațională	min	Hz	50
Consumul de energie	max	VA	3.5
Putere disipată Max		W	2.7
<b>Măsurarea intrărilor de tensiune</b>			
Tensiune nominală (Ue)	fază-fază	VAC	400
	fază neutură	VAC	230
Gama de tensiune de operare	fază-fază	VAC	323...456
	fază neutură	VAC	187...264
Metoda de conectare	Via CT		
<b>Curent</b>			
maxim IEC (Imax)		A	5
minim IEC (Imin)		A	0.05
nominal IEC (Iref-Ib)		A	5
de pornire IEC (Ist)		mA	0.005
de tranziție (Itr)		A	0.25
<b>Precizie</b>			
	Energie activa	Class B (EN 50470-3)	
	Energia reactivă	Clasa 2 (IEC/EN 62053-23)	
<b>Caracteristici de ieșire</b>			
Frecvența pulsului LED		pulse/kWh	10000
Durata impulsului LED		ms	30
<b>Izolații</b>			
Tensiune nominală de izolație Ui IEC/EN		V	250
Tensiune nominală de rezistență la impuls Uimp		kV	6
Tensiunea de rezistență a frecvenței de operare		kV	4
<b>Caracteristici mecanice</b>			
Tip de locuință	Poliamidă		
Terminale Tip	Fix		
Secțiunea transversală a conductorului	IEC min	mm <sup>2</sup>	0.2

	IEC max	mm <sup>2</sup>	4 for supply voltage measurement; 2.5 for current measurement
	AWG/Kcmil min	AWG	24
	AWG/Kcmil max	AWG	12

Cuplu de strângere (Max)

	Nm	0.8
	lbin	7

Fixare		Sina din
--------	--	----------

Greutate	g	332
----------	---	-----

Conditii ambientale

Temperatura

Temperatura de Operare

min	°C	-25
max	°C	+55

Temperatura de depozitare

min	°C	-25
max	°C	+70

Umiditate relativă	%	<80
--------------------	---	-----

Gradul maxim de poluare		2
-------------------------	--	---

Mediu mecanic		Clasa M1
---------------	--	----------

Mediu magnetic		Class E2
----------------	--	----------

Dimensiuni

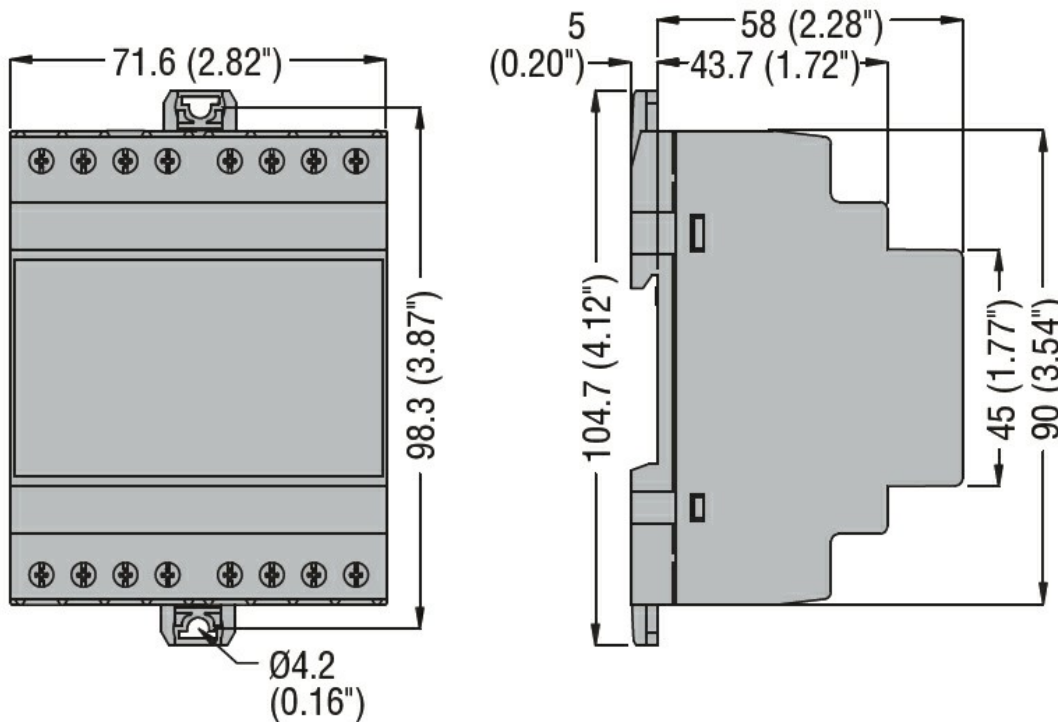

Diagrame de cablare

Single-phase

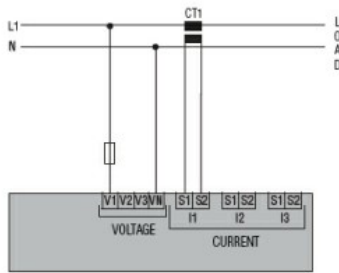

Two-phase

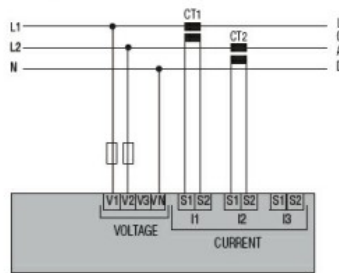

Three-phase with or without neutral

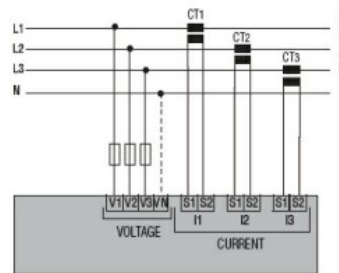

Three-phase without neutral in ARON connection

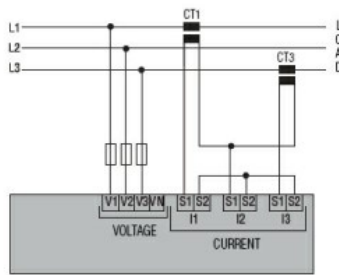
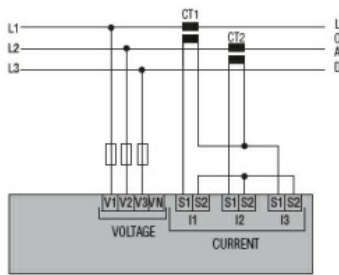

Tariff input

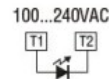

Pulse output 30VDC 50mA for DME D305 T2

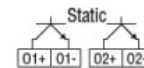

RS485 for DME D330



M-Bus for DME D332



**Certificari si conformitate**

Conformitate

EN50470-1

EN50470-3

TR 50579

Certificate

EAC

MID (moduli B + D)

RCM

**Clasificare ETIM**

ETIM 8.0

EC001506 -  
Contor de  
energie electrică