

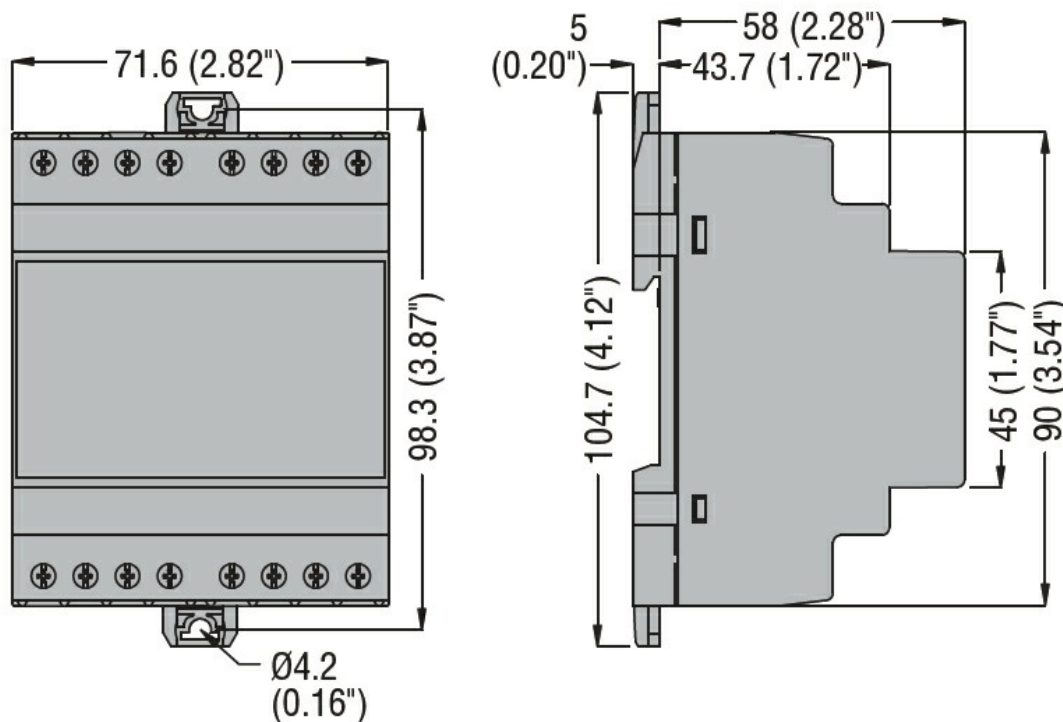

Denumirea produsului	Contoare de energie trifazate DMED332		
Denumirea tipului de produs	Trifazat cu și fără neutru		
Tip	4		
Numărul modului șină DIN	4		
Sursa auxiliara US			
Frecvența operațională	min	Hz	50
	max	Hz	60
Consumul de energie	max	VA	3.5
Putere disipată Max		W	2.7
Măsurarea intrărilor de tensiune			
Tensiune nominală (Ue)	fază-fază	VAC	380...415
	fază neutră	VAC	220...240
Gama de tensiune de operare	fază-fază	VAC	323...456
	fază neutră	VAC	187...264
Metoda de conectare	Via CT		
Curent			
maxim IEC (Imax)		A	5
minim IEC (Imin)		A	0.05
nominal IEC (Iref-Ib)		A	5
de pornire IEC (Ist)		mA	0.005
de tranziție (Itr)		A	0.25
Precizie			
	Energie activa		Class 0.5s (IEC/EN 62053-22)
	Energia reactivă		Clasa 2 (IEC/EN 62053-23)
Caracteristici de ieșire			
Frecvența pulsului LED		pulse/kWh	1000
Durata impulsului LED		ms	30
Izolații			
Tensiune nominală de izolație Ui IEC/EN		V	250
Tensiune nominală de rezistență la impuls Uimp		kV	6
Tensiunea de rezistență a frecvenței de operare		kV	4
Caracteristici mecanice			
Tip de locuință			Poliamidă
Terminale Tip			Fix
Secțiunea transversală a conductorului	IEC min	mm ²	0.2

	IEC max	mm ²	4 for supply voltage measurement; 2.5 for current measurement
	AWG/Kcmil min	AWG	24
	AWG/Kcmil max	AWG	12
Cuplu de strângere (Max)		Nm	0.8
		lbin	7
Fixare			Sina din
Greutate		g	332
Conditii ambientale			
Temperatura			
	Temperatura de Operare		
	min	°C	-25
	max	°C	+55
	Temperatura de depozitare		
	min	°C	-25
	max	°C	+70
Umiditate relativă		%	<80
Gradul maxim de poluare			2

Dimensiuni



Diagrame de cablare

Single-phase

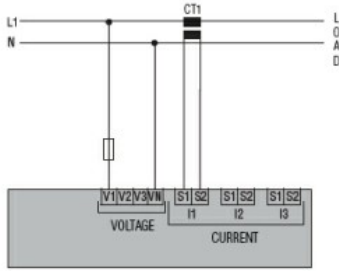

Two-phase

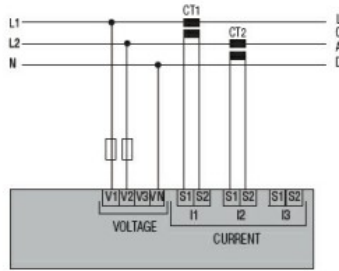

Three-phase with or without neutral

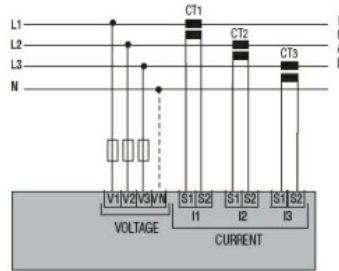

Three-phase without neutral in ARON connection

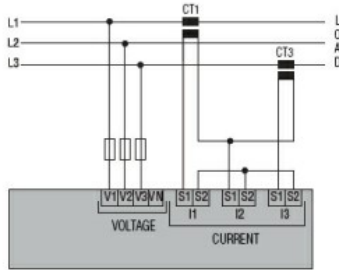
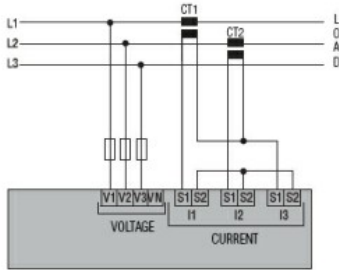

Tariff input

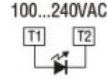

Pulse output 30VDC 50mA for DME D305 T2

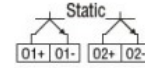

RS485 for DME D330



M-Bus for DME D332

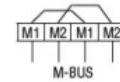

Certificari si conformitate

Conformitate

- IEC/EN 50470-1
- IEC/EN 61010-1
- IEC/EN 61010-2-030

Certificate

- EAC
- RCM

Clasificare ETIM

ETIM 8.0

EC001506 -
Contor de
energie electrică