



Flush-mount LCD
multimeters.
expandable
DMG600
Three-phase +
neutral

Product designation

Product type designation

Type

Auxiliary supply Us

Auxiliary rated supply voltage AC	VAC	100...440
Auxiliary rated supply voltage DC	VDC	120...250
Auxiliary operating voltage range		
AC		
	min	VAC 90
	Max	VAC 484
DC		
	min	VDC 93.5
	Max	VDC 300

Operational frequency		
	min	Hz 45
	max	Hz 66

Power consumption	Max	VA 9.5
-------------------	-----	--------

Power dissipation Max	W	3.5
-----------------------	---	-----

Measuring voltage inputs

Rated voltage (Ue)		
	phase-phase	VAC 600
	phase-neutral	VAC 300

Operating voltage range		
	phase-phase	VAC 50...720
	phase-neutral	VAC 30...360

Voltage inputs operational frequency		
	min	Hz 45
	max	Hz 66

Voltage inputs measurement method		True RMS
-----------------------------------	--	----------

Connection method		Single. two. three-phase with or without neutral. balanced three- phase system
-------------------	--	--

Current inputs

Rated current (Ie)	A	1A/5A
--------------------	---	-------

Measurement range		0.025...6A
-------------------	--	------------

Measurement method		TRMS
--------------------	--	------

Overload capacity		+20% Ie by external CT with 5A secondary
-------------------	--	--

Overload peak	A	50A for 1s
---------------	---	------------

Accuracy

VLN voltage	±0.5%
VLL voltage	±0.5%
Current	±0.5%
Frequency	±0.05%
Active power	±0.5%
Active energy	Class 1 (IEC/EN 62053-21)
Reactive energy	Class 2 (IEC/EN 62053-23)

Insulations

Rated insulation voltage Ui IEC/EN	V	600
Rated impulse withstand voltage Uimp	kV	9.5
Operating frequency withstand voltage	kV	5.2

Functions

Harmonic analysis	15th order
PLC logic	No
Type of communication port	No
Ethernet-RS485 gateway function	No

Mechanical features

Housing type	Polyamide	
Terminals type	Removable	
Conductor cross section		
	min mm ²	0.2
	Max mm ²	2.5
	min AWG	24
	Max AWG	12

Tightening torque (Max)

Nm	0.5
lbin	4.5

Fixing	Flush-mounting
Weight	g 300

Ambient conditions

Temperature

Operating temperature

min	°C	-20
max	°C	+60

Storage temperature

min	°C	-30
max	°C	+80

Relative humidity	%	<90
Maximum Pollution degree		2
Protection degree		IP54

Dimensions

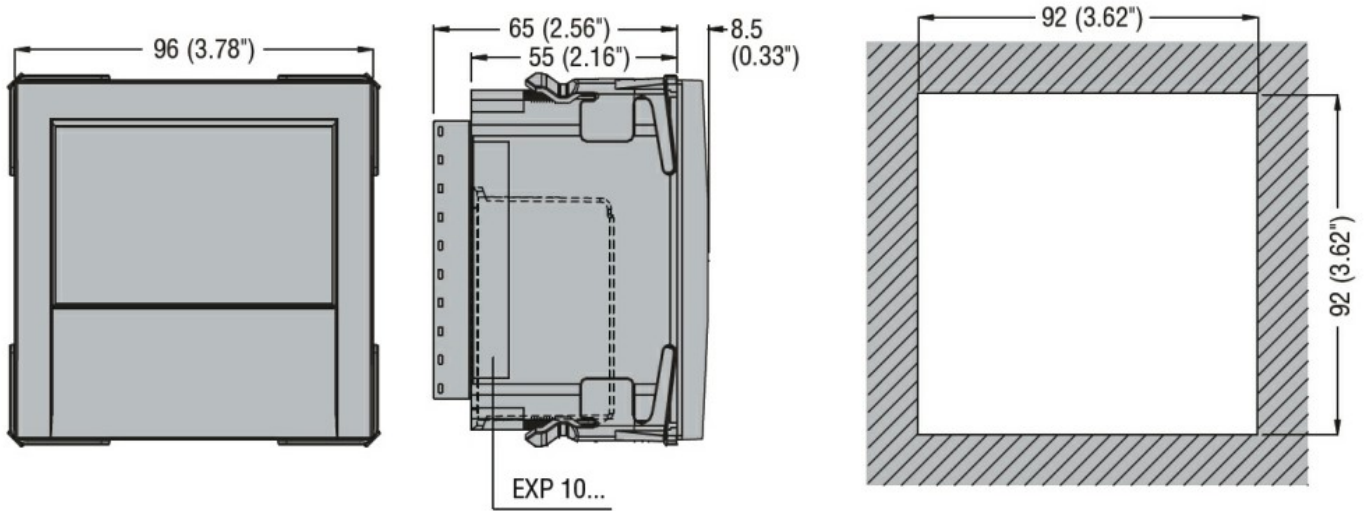

Wiring diagrams

Single-phase

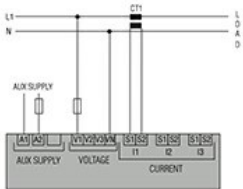

Two-phase

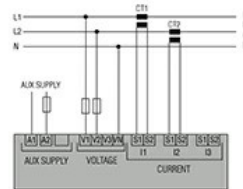

Three-phase with or without neutral

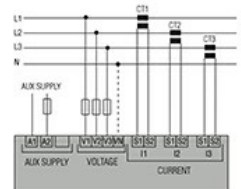

Three-phase without neutral in ARON connection

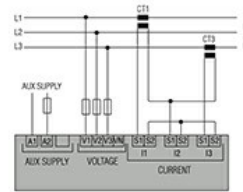
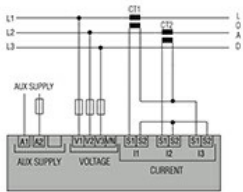

Balanced 3-phase connection with or without neutral

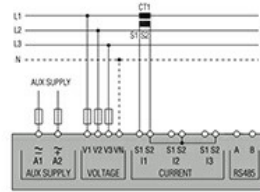

CODE	AUX SUPPLY
DMG100-110-200-210-300	100...240VAC 110...250VDC
DMG6...	100...440VAC 110...250VDC
DMG7000-7500-8000-9000	100...240VAC 110...250VDC



Certifications and compliance

Compliance

- CSA 22.2 n°61010-1
- IEC/EN 61000-6-2
- IEC/EN 61000-6-3
- IEC/EN 61010-1
- IEC/EN 61010-2-030
- UL61010-1

Certificates

- cULus
- EAC
- GOST
- RCM

ETIM classification

ETIM 8.0

EC002301 -
Multifunction
measuring
instrument