



Three-phase
energy meters
DMED330MID
Three-phase +
neutral
4

Product designation			
Product type designation			
Type			
DIN rail module number	4		
Auxiliary supply Us			
Operational frequency	min	Hz	50
Power consumption	Max	VA	3.5
Power dissipation Max		W	2.7
Measuring voltage inputs			
Rated voltage (Ue)	phase-phase	VAC	400
	phase-neutral	VAC	230
Operating voltage range	phase-phase	VAC	323...456
	phase-neutral	VAC	187...264
Connection method	Via CT		
Current			
IEC maximum (Imax)		A	5
IEC minimum (Imin)		A	0.05
IEC rated (Iref-Ib)		A	5
IEC start (Ist)		mA	0.005
Transition (Itr)		A	0.25
Accuracy			
	Active energy	Class B (EN 50470-3)	
	Reactive energy	Class 2 (IEC/EN 62053-23)	
Output characteristics			
LED Pulse rate		pulse/kWh	10000
LED Pulse duration		ms	30
Insulations			
Rated insulation voltage Ui IEC/EN		V	250
Rated impulse withstand voltage Uimp		kV	6
Operating frequency withstand voltage		kV	4
Mechanical features			
Housing type	Polyamide		
Terminals type	Fixed		
Conductor cross section	min	mm ²	0.2

				4 for supply voltage measurement; 2.5 for current measurement
	Max	mm ²		
	min	AWG		24
	Max	AWG		12
<hr/>				
Tightening torque (Max)			Nm	0.8
			lbin	7
<hr/>				
Fixing				Din rail
<hr/>				
Weight			g	332
<hr/>				
Ambient conditions				
Temperature				
	Operating temperature			
	min	°C		-25
	max	°C		+55
	Storage temperature			
	min	°C		-25
	max	°C		+70
<hr/>				
Relative humidity			%	<80
<hr/>				
Maximum Pollution degree				2
<hr/>				
Mechanical environment				Class M1
<hr/>				
Magnetic environment				Class E2

Dimensions

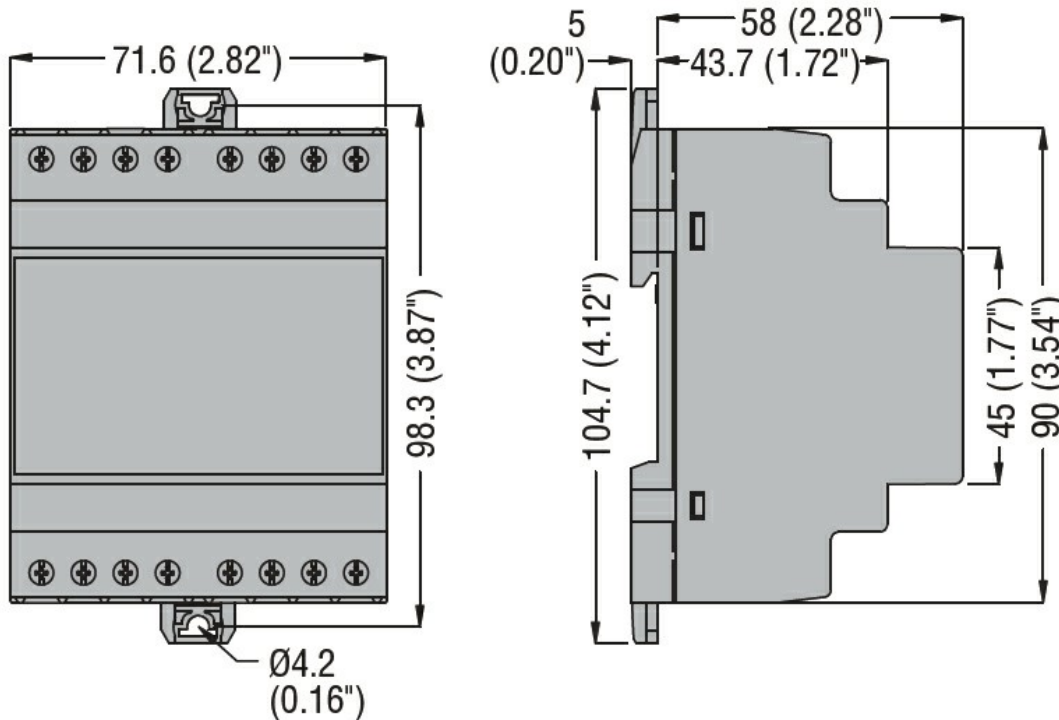

Wiring diagrams

Single-phase

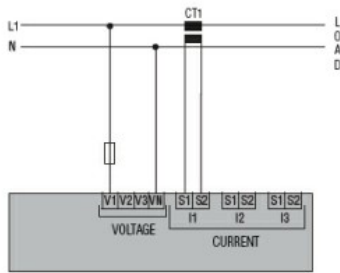

Two-phase

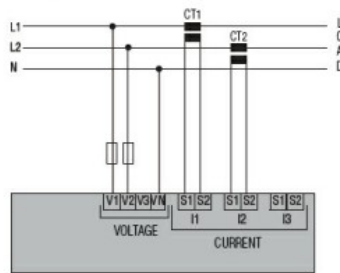

Three-phase with or without neutral

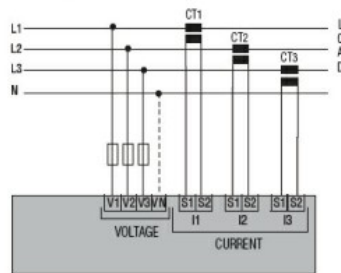

Three-phase without neutral in ARON connection

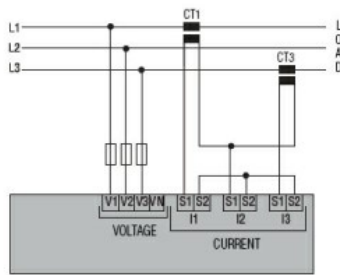
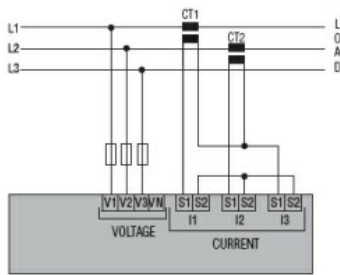

Tariff input

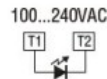

Pulse output 30VDC 50mA for DME D305 T2

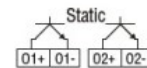

RS485 for DME D330



M-Bus for DME D332

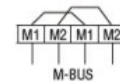

Certifications and compliance

Compliance

EN50470-1

EN50470-3

TR 50579

Certificates

EAC

MID (moduli B + D)

RCM

ETIM classification

ETIM 8.0

EC001506 -
Kilowatt-hour
meter