



Product designation	Three-phase energy meters		
Product type designation	DMED305T2MID		
Type	Three-phase + neutral		
DIN rail module number	4		
Auxiliary supply Us			
Operational frequency	min	Hz	50
Power consumption	Max	VA	3.5
Power dissipation Max		W	2.7
Measuring voltage inputs			
Rated voltage (Ue)	phase-phase	VAC	400
	phase-neutral	VAC	230
Operating voltage range	phase-phase	VAC	323...456
	phase-neutral	VAC	187...264
Connection method	Via CT		
Current			
IEC maximum (Imax)		A	5
IEC minimum (Imin)		A	0.05
IEC rated (Iref-Ib)		A	5
IEC start (Ist)		mA	0.005
Transition (Itr)		A	0.25
Accuracy			
	Active energy	Class B (EN 50470-3)	
	Reactive energy	Class 2 (IEC/EN 62053-23)	
Output characteristics			
LED Pulse rate		pulse/kWh	10000
LED Pulse duration		ms	30
Static output pulse rate		pulse/kWh	0.1-1-10-100 programmable
Static output pulse duration		ms	100
Static output external voltage		VDC	10...30
Static outputs Maximum current		mA	50
Insulations			
Rated insulation voltage Ui IEC/EN		V	250
Rated impulse withstand voltage Uimp		kV	6
Operating frequency withstand voltage		kV	4
Mechanical features			
Housing type	Polyamide		
Terminals type	Fixed		

Conductor cross section

min	mm ²	0.2
		4 for supply voltage measurement;
		2.5 for current measurement
Max	mm ²	
min	AWG	24
Max	AWG	12

Tightening torque (Max)

Nm	0.8
lbin	7

Fixing

Din rail

Weight

g 332

Ambient conditions

Temperature

Operating temperature

min	°C	-25
max	°C	+55

Storage temperature

min	°C	-25
max	°C	+70

Relative humidity

% <80

Maximum Pollution degree

2

Mechanical environment

Class M1

Magnetic environment

Class E2

Dimensions

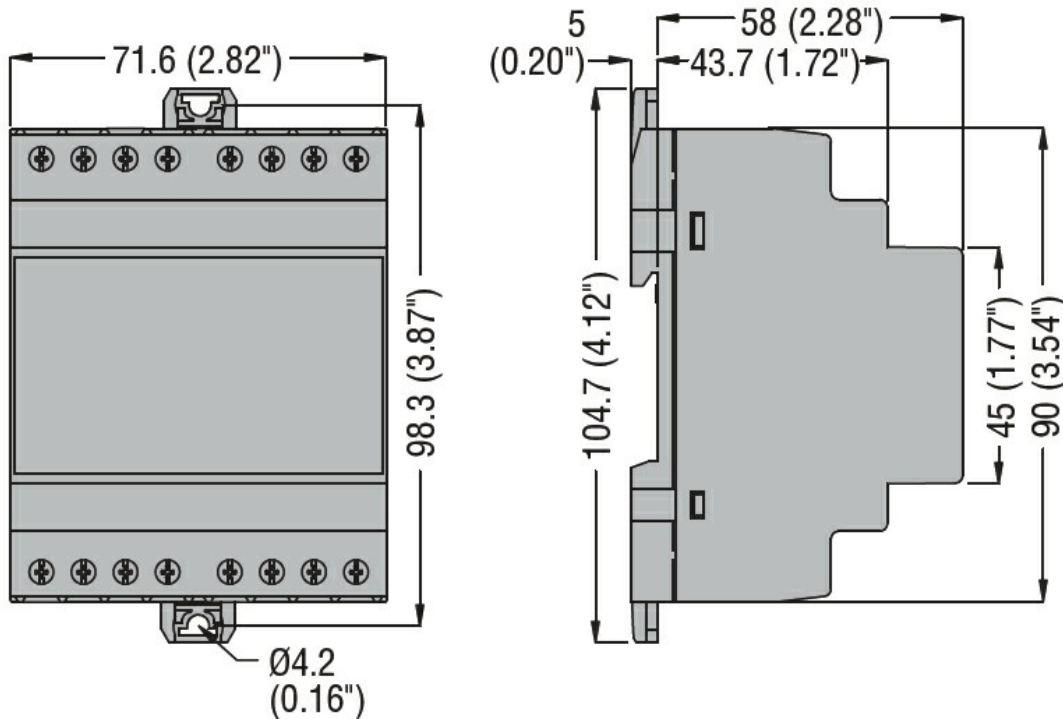

Wiring diagrams

Single-phase

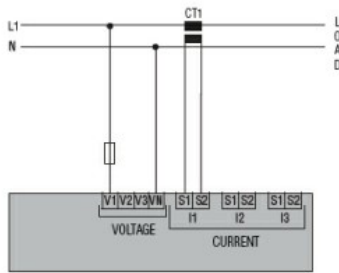

Two-phase

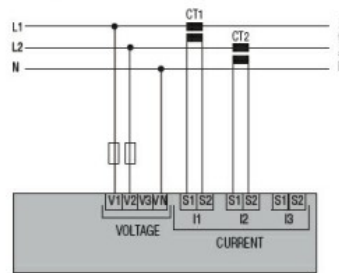

Three-phase with or without neutral

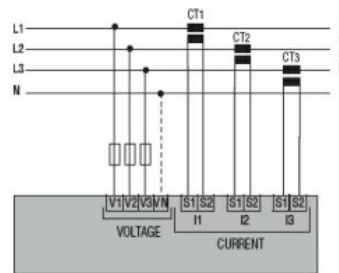

Three-phase without neutral in ARON connection

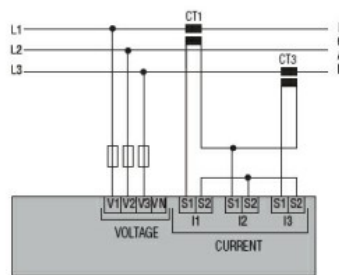
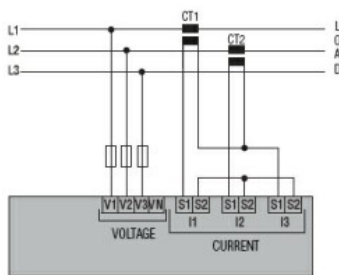

Tariff input

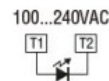

Pulse output 30VDC 50mA for DME D305 T2

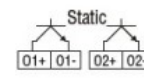

RS485 for DME D330



M-Bus for DME D332

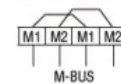

Certifications and compliance

Compliance

EN50470-1

EN50470-3

TR 50579

Certificates

EAC

MID (moduli B + D)

RCM

ETIM classification

ETIM 8.0

EC001506 -
Kilowatt-hour
meter