



Starter stea-
triunghi
M3P03870

Denumirea produsului

Denumirea tipului de produs

Caracteristici electrice

Curent maxim de funcționare ($\leq 440V$) A 60

Componente

Carcasa de pornire standard furnizată M3PA70

Contactor standard furnizat BF3800A,
BF3800A,
BF2510A

Releul termic se achiziționează separat RF38...

Standard de contact auxiliar furnizat BFX1020,
BFX1011,
BFX1011

Caracteristicile contactului

Puterile motorului standard IEC

230V	kW	15
400V	kW	30
440V	kW	30
500V	kW	30

Caracteristici mecanice

Greutate g 3800

Condiții ambientale

Temperatura de Operare

Temperatura min	°C	-25
Temperatura max	°C	+60

Temperatura de depozitare

Temperatura min	°C	-40
Temperatura max	°C	+70

Rezistență și protecție

Grad IP frontal IP65

Dimensiuni

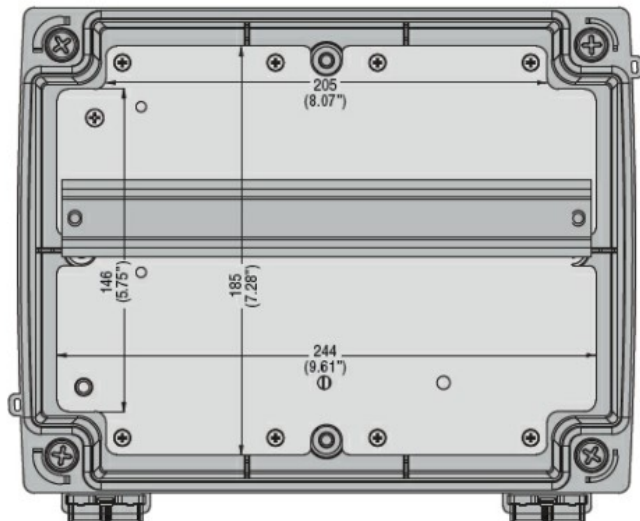
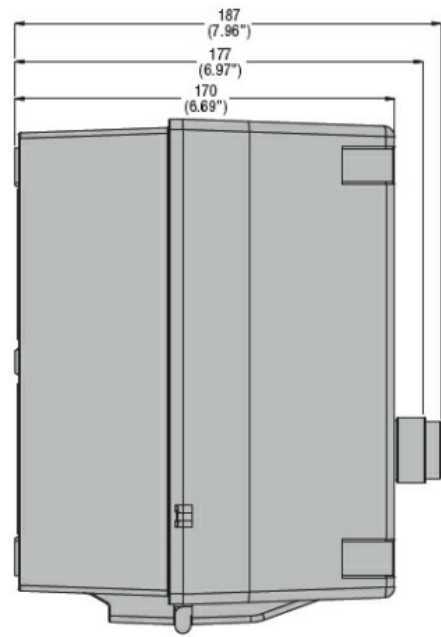
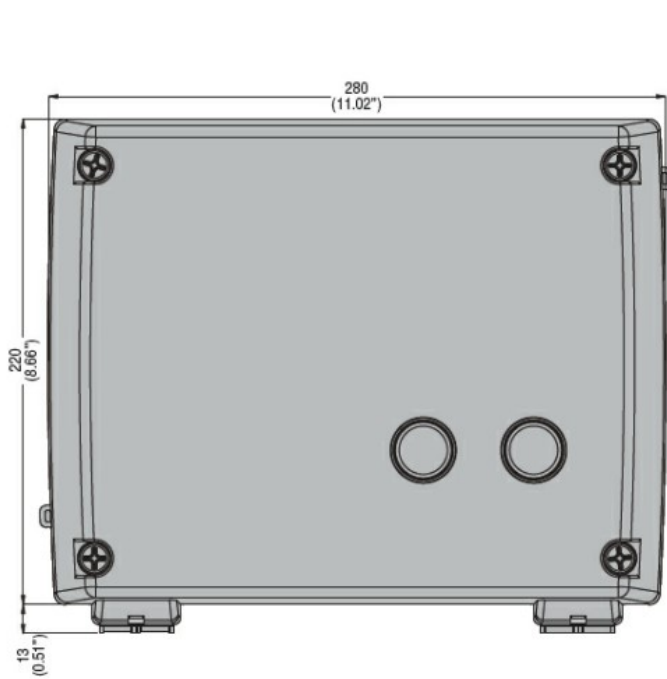

Drilling for surface fixing

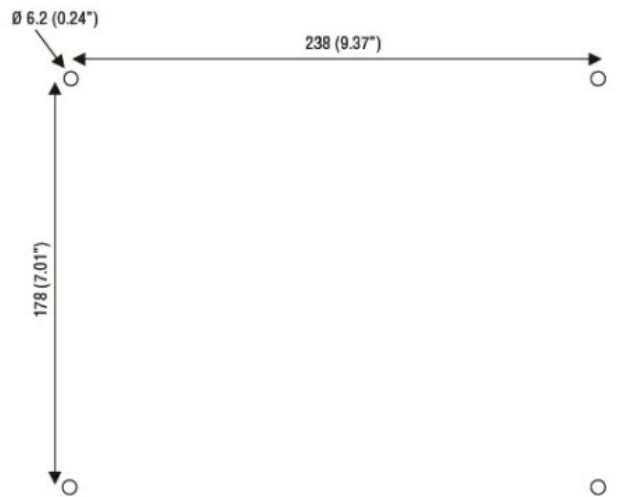

Diagrame de cablare

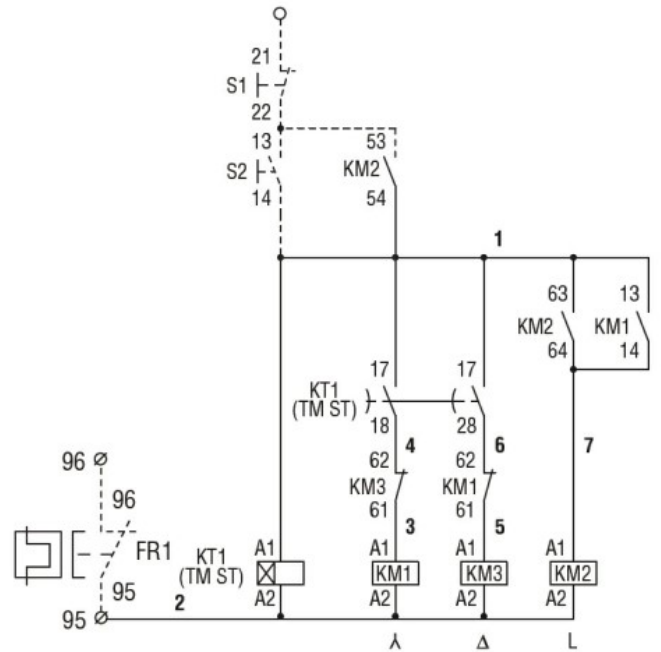
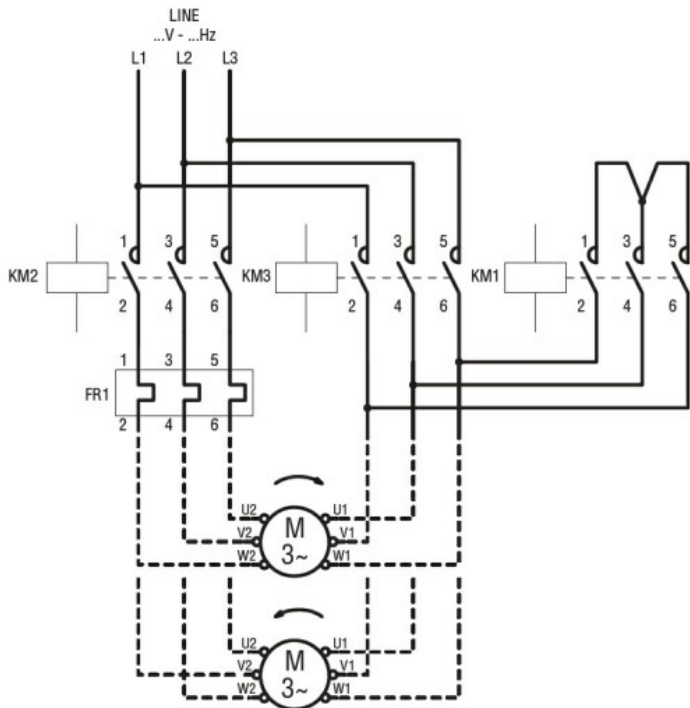

Certificari si conformitate

Conformitate

CSA C22.2 n° 14

for starters

IEC/EN 60947-1

IEC/EN 60947-4-1

UL508

Certificate

/

Clasificare ETIM

ETIM 8.0

EC001037 -
Combinatie
starter
motor/starter
motor