



Starter stea-  
triunghi  
M3P03270

Denumirea produsului

Denumirea tipului de produs

**Caracteristici electrice**

Curent maxim de funcționare ( $\leq 440V$ ) A 50

**Componente**

Carcasa de pornire standard furnizată M3PA70

Contactor standard furnizat BF3200A,  
BF3200A,  
BF2510A

Releul termic se achiziționează separat RF38...

Standard de contact auxiliar furnizat BFX1020,  
BFX1011,  
BFX1011

**Caracteristicile contactului**

Puterile motorului standard IEC

230V	kW	15
400V	kW	25
440V	kW	25
500V	kW	25

**Caracteristici mecanice**

Greutate g 3800

**Condiții ambientale**

Temperatura de Operare

Temperatura min	°C	-25
Temperatura max	°C	+60

Temperatura de depozitare

Temperatura min	°C	-40
Temperatura max	°C	+70

**Rezistență și protecție**

Grad IP frontal IP65

**Dimensiuni**

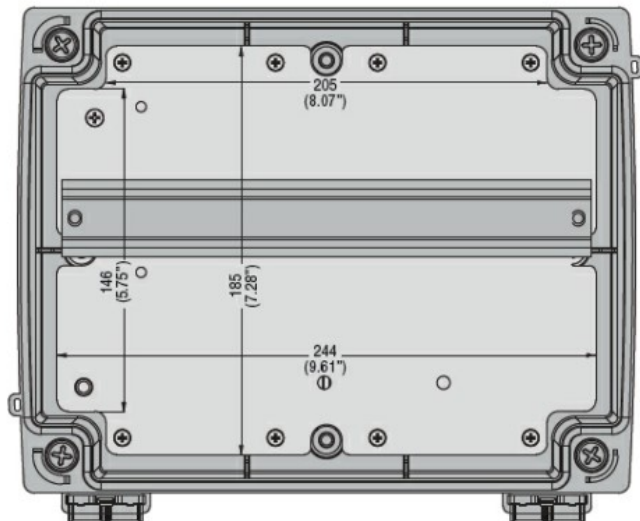
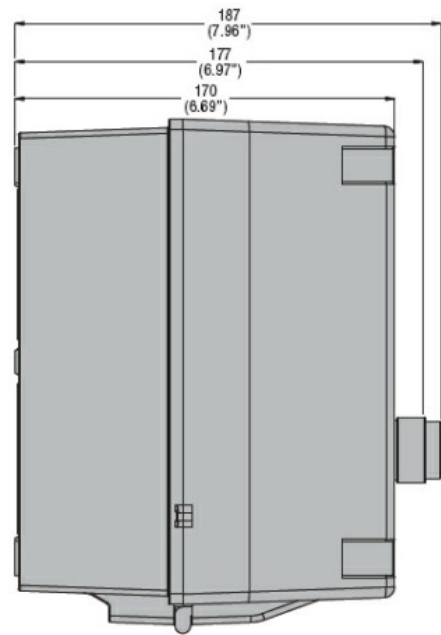
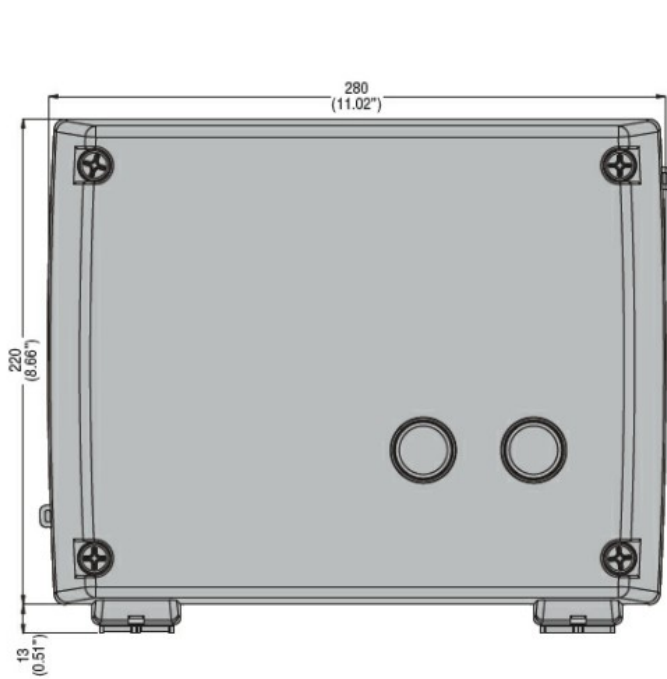

Drilling for surface fixing

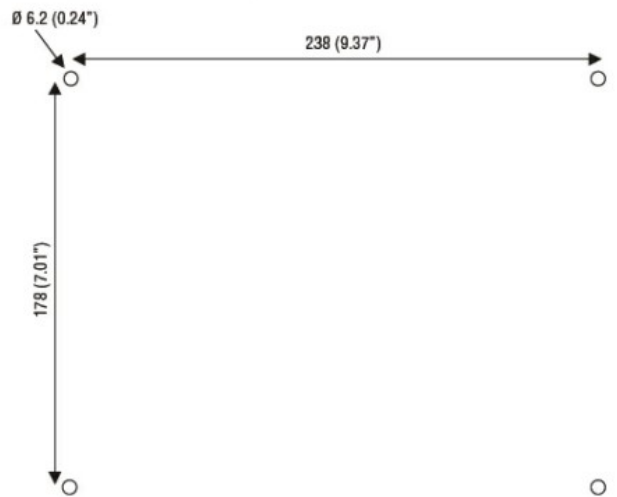

**Diagrame de cablare**

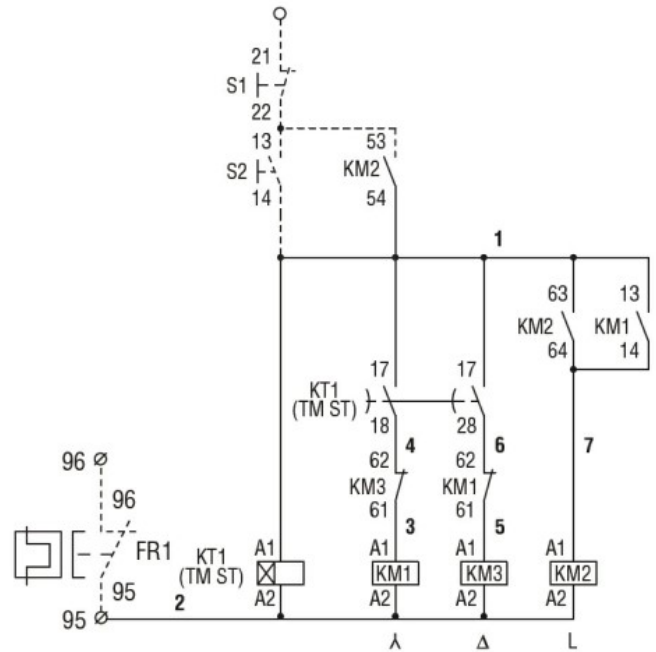
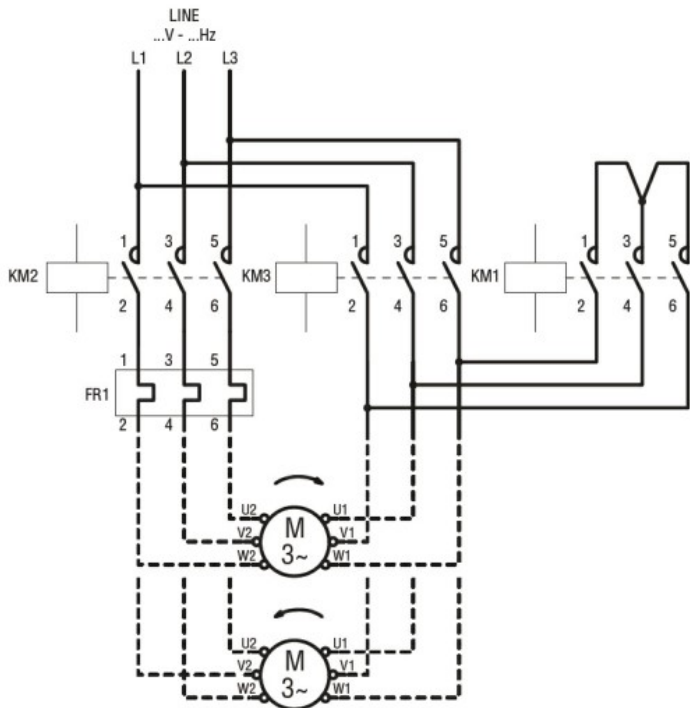

### Certificari si conformitate

#### Conformitate

CSA C22.2 n° 14

for starters

IEC/EN 60947-1

IEC/EN 60947-4-1

UL508

#### Certificate

/

### Clasificare ETIM

ETIM 8.0

EC001037 -  
Combinatie  
starter  
motor/starter  
motor