



Denumirea produsului

Starter stea-triunghi

Denumirea tipului de produs

BFA050

Caracteristici electrice

Curent maxim de funcționare ($\leq 440V$)

A 85

Componente

Contactor standard furnizat

BF5000A /
BF5000A /
BF3200A

Releu termic standard furnizat

No

Releul termic se achiziționează separat

RF82

Standard de contact auxiliar furnizat

BFX1020 /
BFX1011 /
BFX1011

Caracteristicile contactului

Puterile motorului standard IEC

230V	kW	25
400V	kW	45
440V	kW	45
500V	kW	59

Caracteristici mecanice

Greutate

g 5200

Dimensiuni

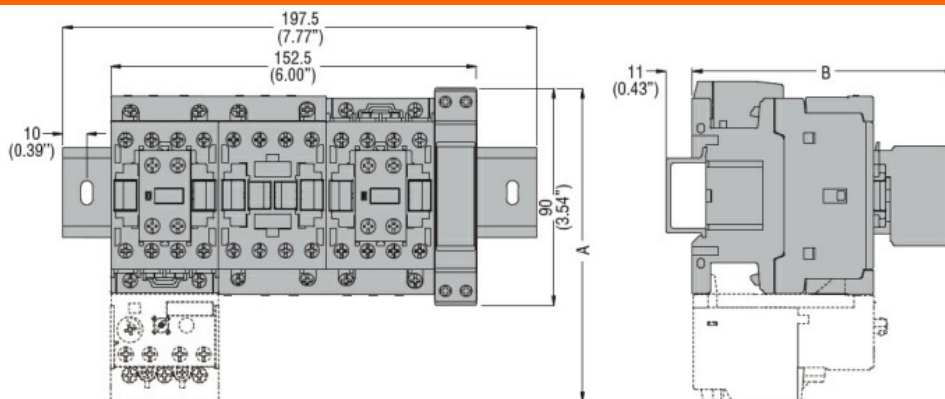

STARTER TYPE	A	B
BFA009 70	130.5 (5.14")	109.5 (4.31")
BFA012 70	130.5 (5.14")	109.5 (4.31")
BFA018 70	130.5 (5.14")	109.5 (4.31")
BFA025 70	130.5 (5.14")	109.5 (4.31")
BFA026 70	135 (5.14")	119 (4.68")
BFA032 70	135 (5.14")	119 (4.68")
BFA038 70	135 (5.14")	119 (4.68")
BFA050 70	173 (6.81")	142 (5.59")
BFA065 70	173 (6.81")	142 (5.59")
BFA080 70	183 (7.20")	142 (5.59")

Diagrame de cablare



Certificari si conformitate

Conformitate

IEC/EN 60947-1
IEC/EN 60947-4-9

Certificate

/

Clasificare ETIM

ETIM 8.0

EC001037 -
Combinatie
starter
motor/starter
motor