



Denumirea produsului

Starter stea-  
triunghi

Denumirea tipului de produs

BFA032

**Caracteristici electrice**

Curent maxim de funcționare ( $\leq 440V$ )

A 50

**Componente**

Contactor standard furnizat

BF3200A /  
BF3200A /  
BF2510A

Releu termic standard furnizat

No

Releul termic se achiziționează separat

RF38

Standard de contact auxiliar furnizat

BFX1020 /  
BFX1011 /  
BFX1011

**Caracteristicile contactului**

Puterile motorului standard IEC

230V	kW	15
400V	kW	25
440V	kW	25
500V	kW	25

**Caracteristici mecanice**

Greutate

g 1900

**Dimensiuni**

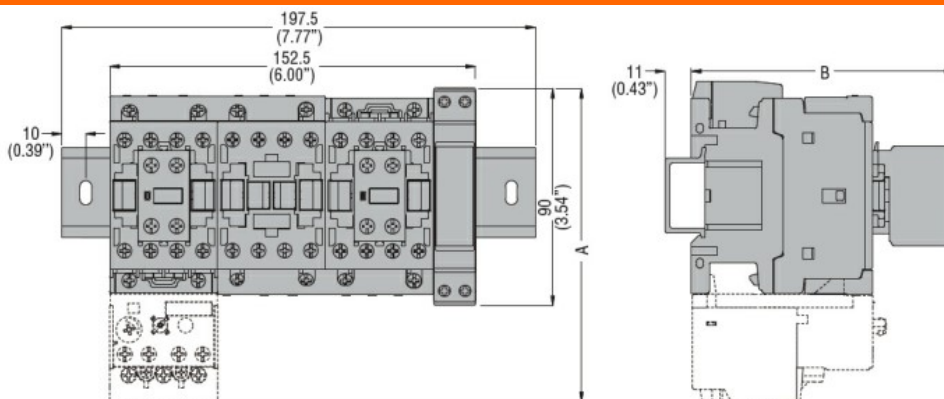

STARTER TYPE	A	B
BFA009 70	130.5 (5.14")	109.5 (4.31")
BFA012 70	130.5 (5.14")	109.5 (4.31")
BFA018 70	130.5 (5.14")	109.5 (4.31")
BFA025 70	130.5 (5.14")	109.5 (4.31")
BFA026 70	135 (5.14")	119 (4.68")
BFA032 70	135 (5.14")	119 (4.68")
BFA038 70	135 (5.14")	119 (4.68")
BFA050 70	173 (6.81")	142 (5.59")
BFA065 70	173 (6.81")	142 (5.59")
BFA080 70	183 (7.20")	142 (5.59")

**Diagrame de cablare**

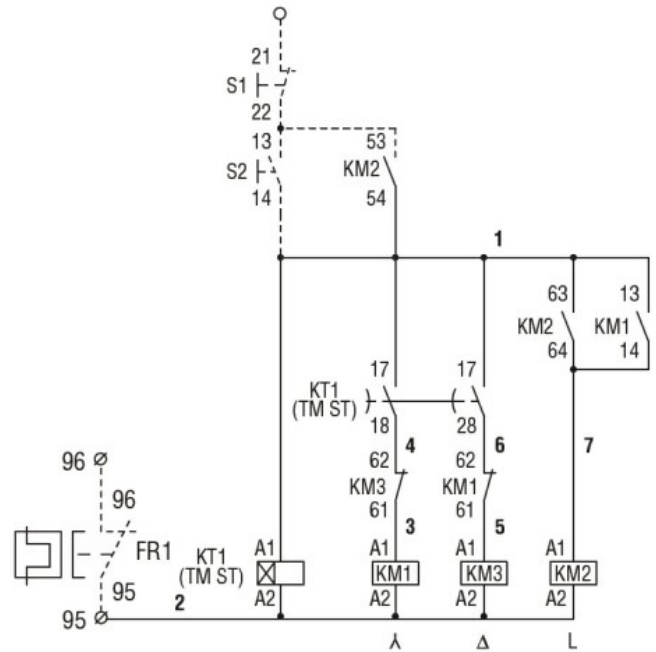
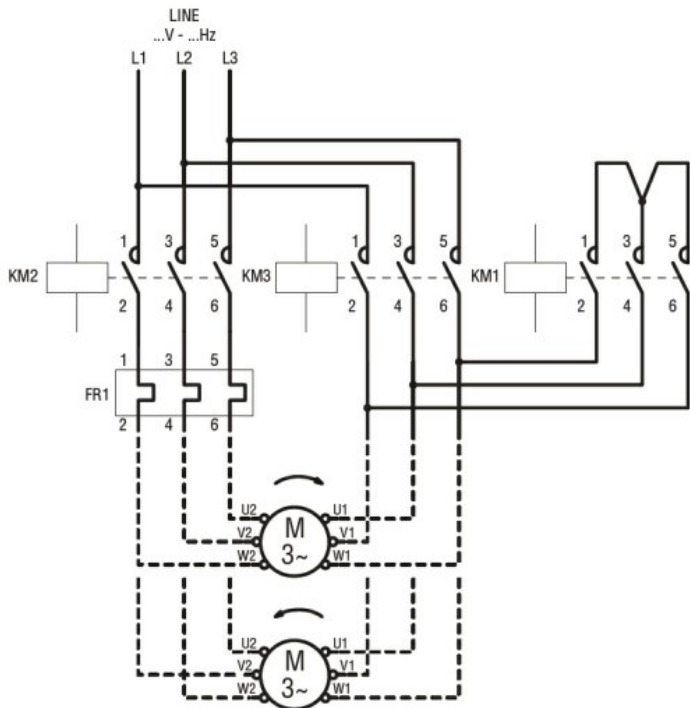

**Certificari si conformitate**

Conformitate

IEC/EN 60947-1

IEC/EN 60947-4-9

Certificate

/

**Clasificare ETIM**

ETIM 8.0

EC001037 -  
Combinatie  
starter  
motor/starter  
motor