



Denumirea produsului

Starter stea-
triunghi

Denumirea tipului de produs

BFA018

Caracteristici electrice

Curent maxim de funcționare ($\leq 440V$)

A 28

Componente

Contactor standard furnizat

BF1810A /
BF1801A /
BF1210A

Releu termic standard furnizat

No

Releul termic se achiziționează separat

RF38

Standard de contact auxiliar furnizat

BFX1020 //
BFX1011

Caracteristicile contactului

Puterile motorului standard IEC

230V	kW	7.5
400V	kW	15
440V	kW	11
500V	kW	11

Caracteristici mecanice

Greutate

g 1700

Dimensiuni

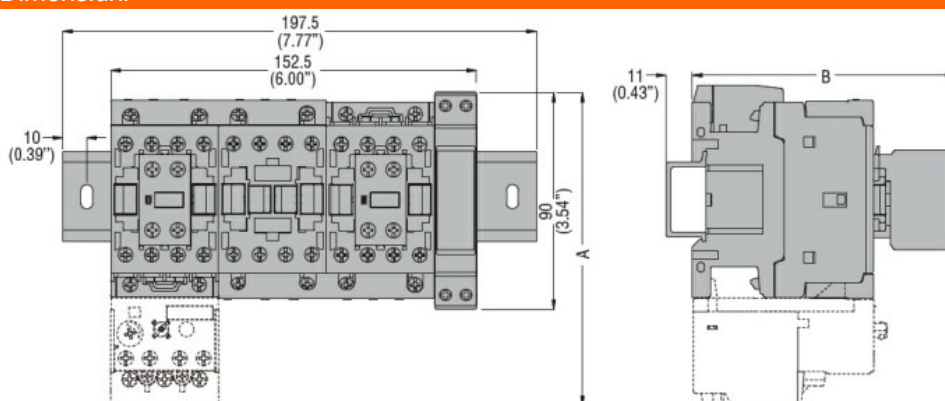

STARTER TYPE	A	B
BFA009 70	130.5 (5.14")	109.5 (4.31")
BFA012 70	130.5 (5.14")	109.5 (4.31")
BFA018 70	130.5 (5.14")	109.5 (4.31")
BFA025 70	130.5 (5.14")	109.5 (4.31")
BFA026 70	135 (5.14")	119 (4.68")
BFA032 70	135 (5.14")	119 (4.68")
BFA038 70	135 (5.14")	119 (4.68")
BFA050 70	173 (6.81")	142 (5.59")
BFA065 70	173 (6.81")	142 (5.59")
BFA080 70	183 (7.20")	142 (5.59")

Diagrame de cablare

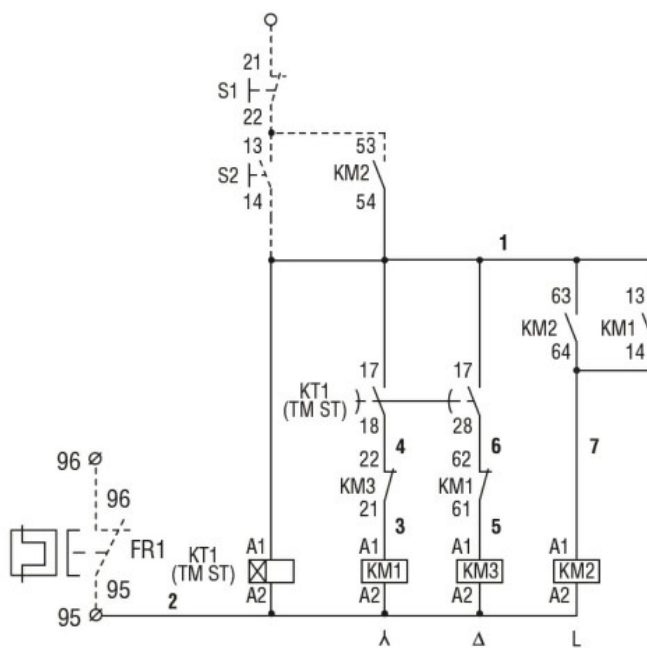
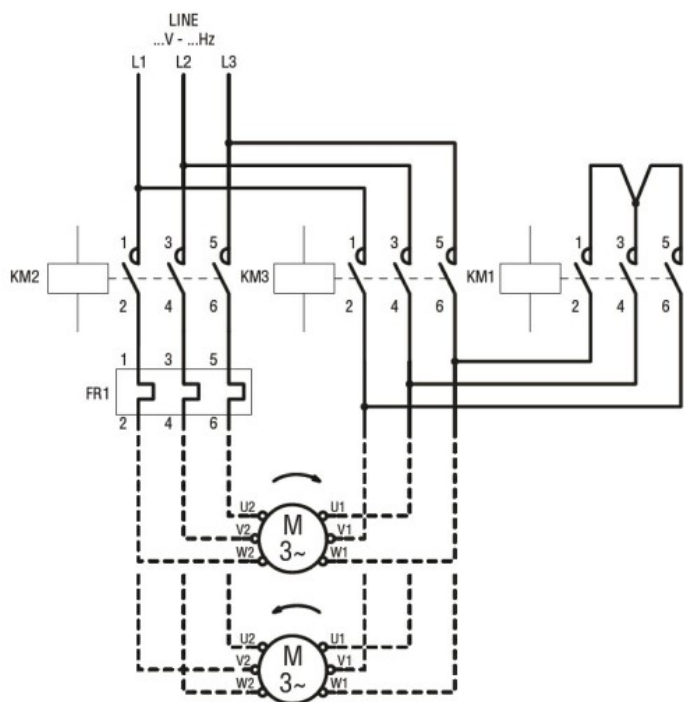

Certificari si conformitate

Conformitate

IEC/EN 60947-1
IEC/EN 60947-4-9

Certificate

/

Clasificare ETIM

ETIM 8.0

EC001037 -
Combinatie
starter
motor/starter
motor