



Enclosed star-delta starters  
M3P03870

Product designation

Product type designation

**Electrical features**

Maximum operating current ( $\leq 440V$ ) A 60

**Components**

Starter enclosure standard supplied M3PA70

Contactor standard supplied BF3800A,  
BF3800A,  
BF2510A

Thermal relay to purchase separately RF38...

Auxiliary contact standard supplied BFX1020,  
BFX1011,  
BFX1011

**Contact characteristics**

IEC standard motor powers

230V	kW	15
400V	kW	30
440V	kW	30
500V	kW	30

**Mechanical features**

Weight g 3800

**Ambient conditions**

Operating temperature

min	°C	-25
max	°C	+60

Storage temperature

min	°C	-40
max	°C	+70

**Resistance & Protection**

Frontal IP degree IP65

**Dimensions**

STAR-DELTA STARTER, ENCLOSED STARTER, WITH START AND STOP/RESET BUTTONS.  
STARTING TIME UP TO 12 SECONDS AND A MAXIMUM OF 30 OPERATIONS/HOUR, MAX IEC  
OPERATING CURRENT 60A. COIL VOLTAGE 400VAC 50/60HZ

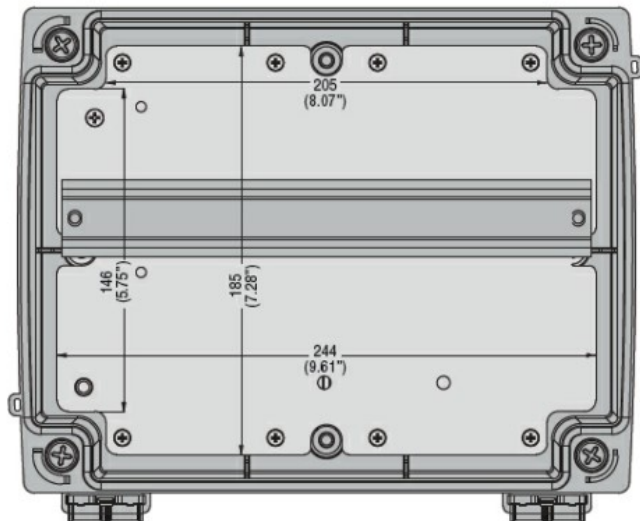
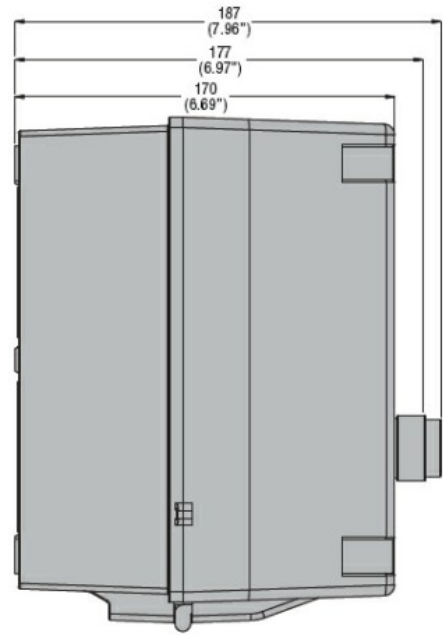
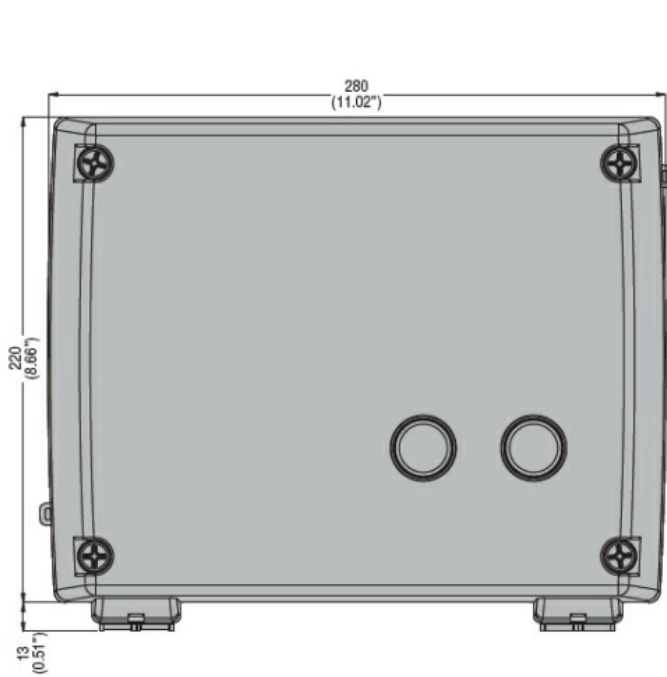

Drilling for surface fixing

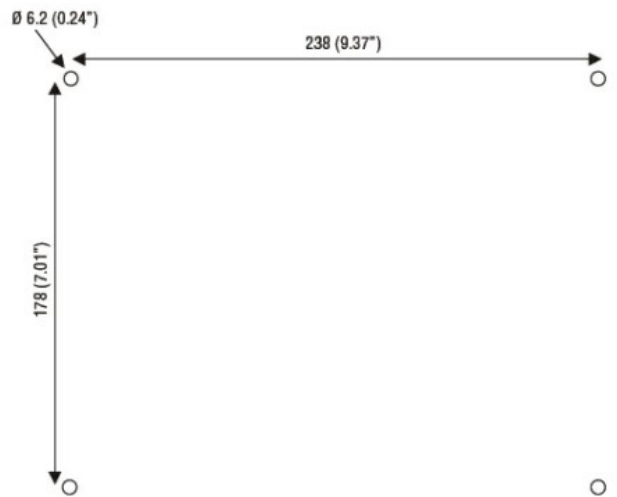

Wiring diagrams

STAR-DELTA STARTER, ENCLOSED STARTER, WITH START AND STOP/RESET BUTTONS.  
STARTING TIME UP TO 12 SECONDS AND A MAXIMUM OF 30 OPERATIONS/HOUR, MAX IEC  
OPERATING CURRENT 60A. COIL VOLTAGE 400VAC 50/60HZ

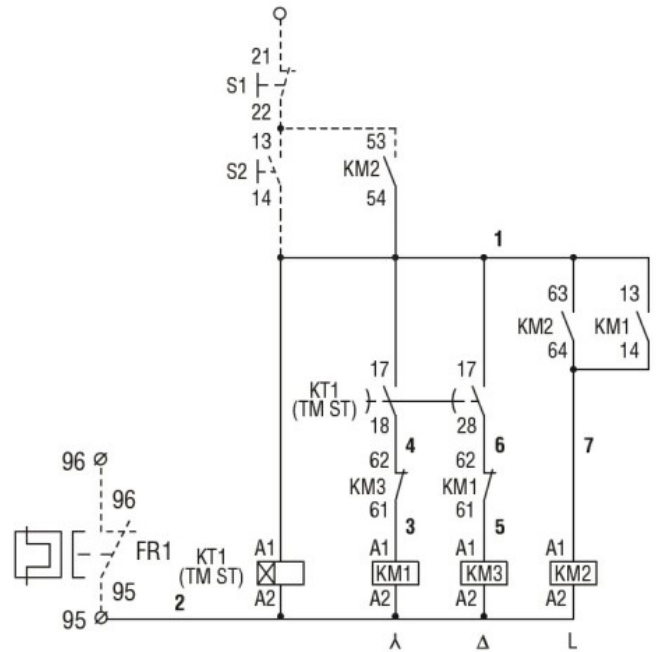
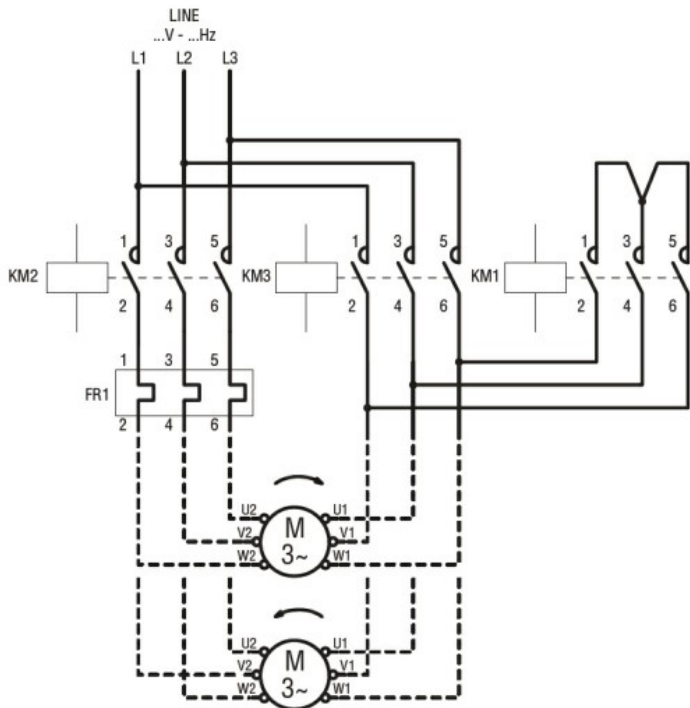

### Certifications and compliance

#### Compliance

CSA C22.2 n° 14  
for starters  
IEC/EN 60947-1  
IEC/EN 60947-4-1  
UL508

#### Certificates

/

### ETIM classification

ETIM 8.0

EC001037 -  
Motor  
starter/Motor  
starter  
combination