



Enclosed star-delta starters  
M3P01270

Product designation

Product type designation

**Electrical features**

Maximum operating current ( $\leq 440V$ ) A 22

**Components**

Starter enclosure standard supplied M3PA70

Contactor standard supplied BF1210A, BF1201A, BF0910A

Thermal relay to purchase separately RF38...

Auxiliary contact standard supplied BFX1020, ..., BFX1011

**Contact characteristics**

IEC standard motor powers

230V	kW	5.5
400V	kW	11
440V	kW	11
500V	kW	11

**Mechanical features**

Weight g 3540

**Ambient conditions**

Operating temperature

min	°C	-25
max	°C	+60

Storage temperature

min	°C	-40
max	°C	+70

**Resistance & Protection**

Frontal IP degree IP65

**Dimensions**

STAR-DELTA STARTER, ENCLOSED STARTER, WITH START AND STOP/RESET BUTTONS.  
STARTING TIME UP TO 12 SECONDS AND A MAXIMUM OF 30 OPERATIONS/HOUR, MAX IEC  
OPERATING CURRENT 22A. COIL VOLTAGE 230VAC 50/60HZ

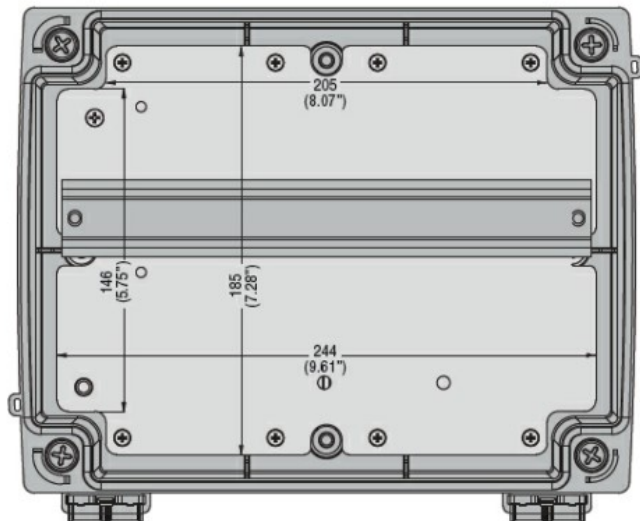
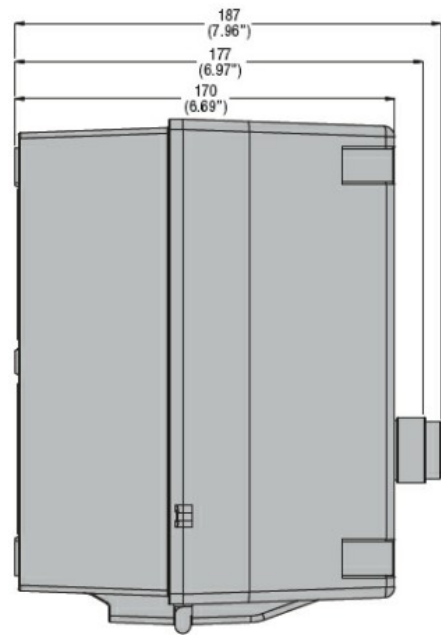
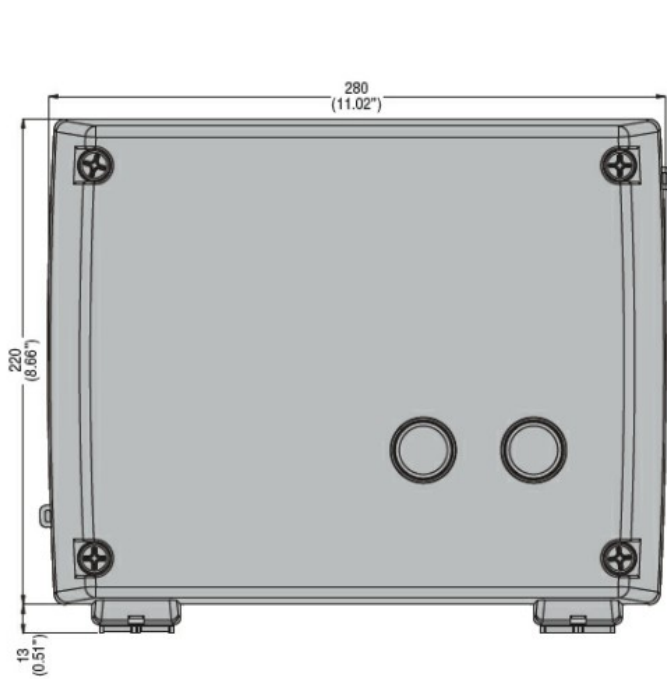

Drilling for surface fixing

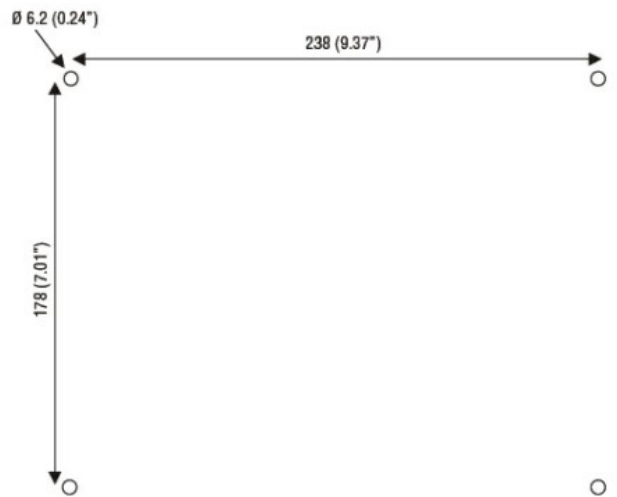

Wiring diagrams

STAR-DELTA STARTER, ENCLOSED STARTER, WITH START AND STOP/RESET BUTTONS.  
STARTING TIME UP TO 12 SECONDS AND A MAXIMUM OF 30 OPERATIONS/HOUR, MAX IEC  
OPERATING CURRENT 22A. COIL VOLTAGE 230VAC 50/60HZ

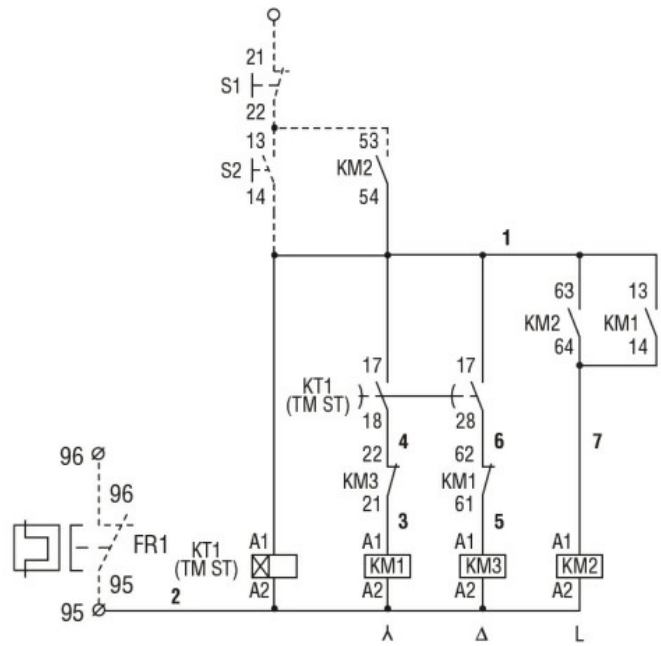
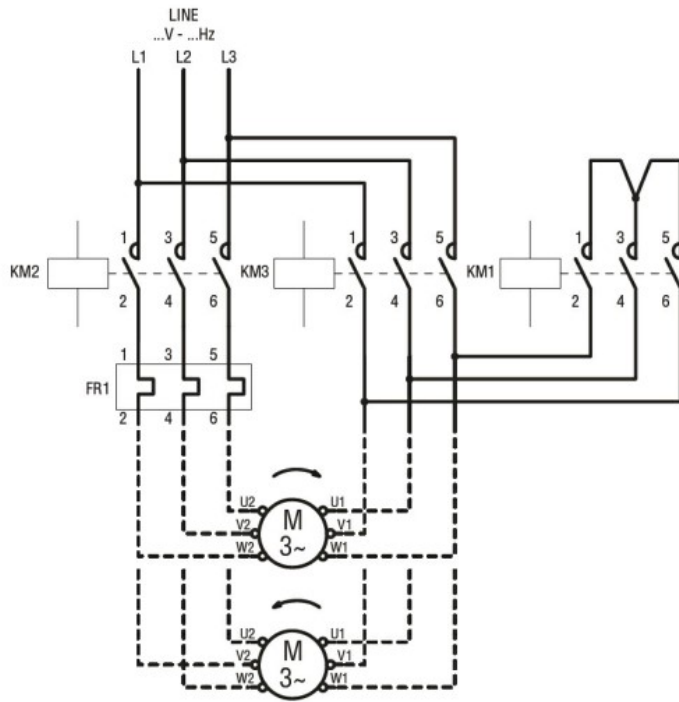

### Certifications and compliance

#### Compliance

CSA C22.2 n° 14

for starters

IEC/EN 60947-1

IEC/EN 60947-4-1

UL508

#### Certificates

/

### ETIM classification

ETIM 8.0

EC001037 -  
Motor  
starter/Motor  
starter  
combination