



Enclosed star-delta starters
M3P00970

Product designation

Product type designation

Electrical features

Maximum operating current ($\leq 440V$) A 16

Components

Starter enclosure standard supplied M3PA70

Contactor standard supplied BF0910A, BF0901A, BF0910A

Thermal relay to purchase separately RF38...

Auxiliary contact standard supplied BFX1020, ..., BFX1011

Contact characteristics

IEC standard motor powers	230V	kW	4
	400V	kW	7.5
	440V	kW	7.5
	500V	kW	7.5

Mechanical features

Weight g 3540

Ambient conditions

Operating temperature	min	°C	-25
	max	°C	+60

Storage temperature	min	°C	-40
	max	°C	+70

Resistance & Protection

Frontal IP degree IP65

Dimensions

STAR-DELTA STARTER, ENCLOSED STARTER, WITH START AND STOP/RESET BUTTONS.
STARTING TIME UP TO 12 SECONDS AND A MAXIMUM OF 30 OPERATIONS/HOUR, MAX IEC
OPERATING CURRENT 16A. COIL VOLTAGE 230VAC 50/60HZ

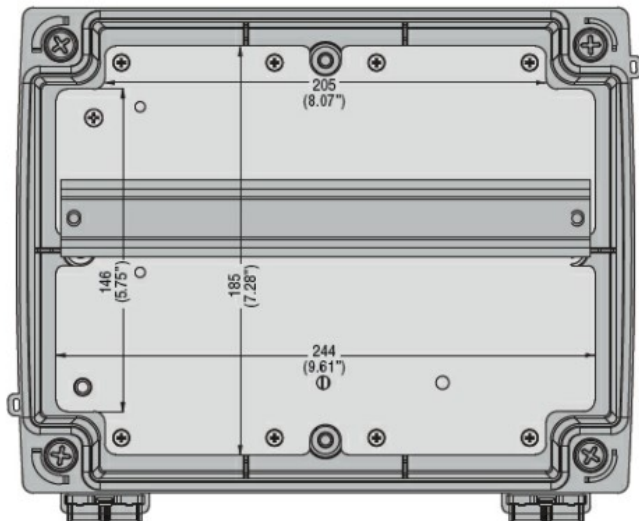
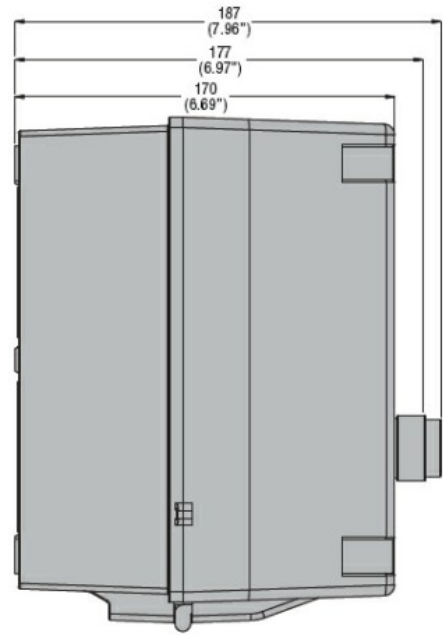
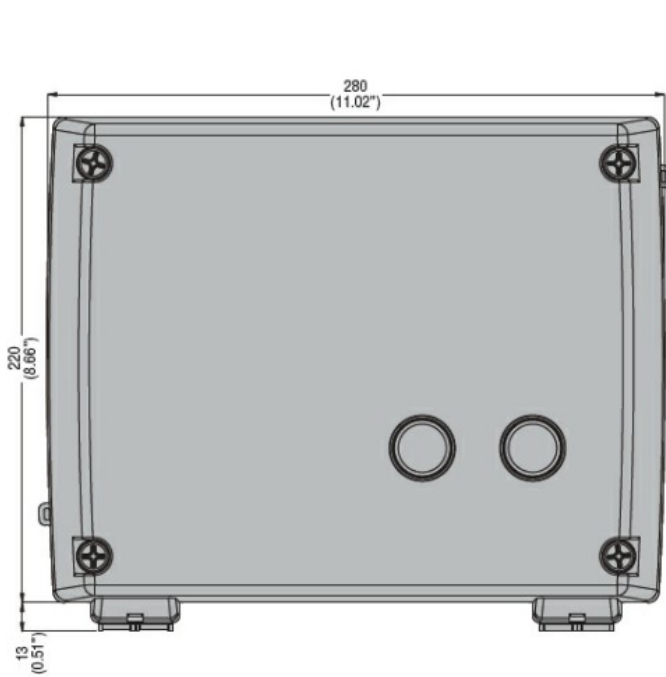

Drilling for surface fixing

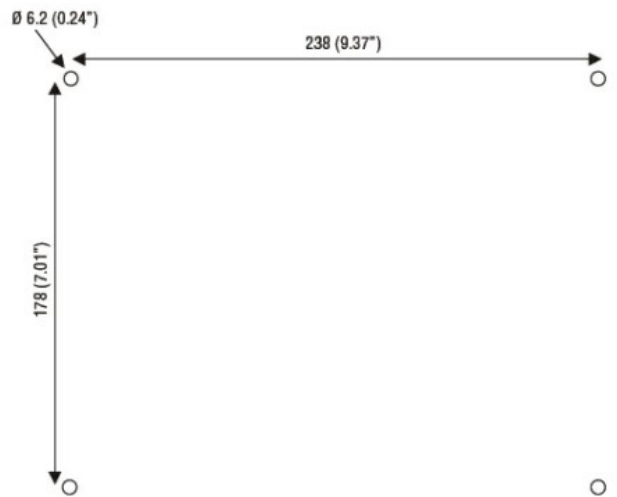

Wiring diagrams

STAR-DELTA STARTER, ENCLOSED STARTER, WITH START AND STOP/RESET BUTTONS.
STARTING TIME UP TO 12 SECONDS AND A MAXIMUM OF 30 OPERATIONS/HOUR, MAX IEC
OPERATING CURRENT 16A. COIL VOLTAGE 230VAC 50/60HZ

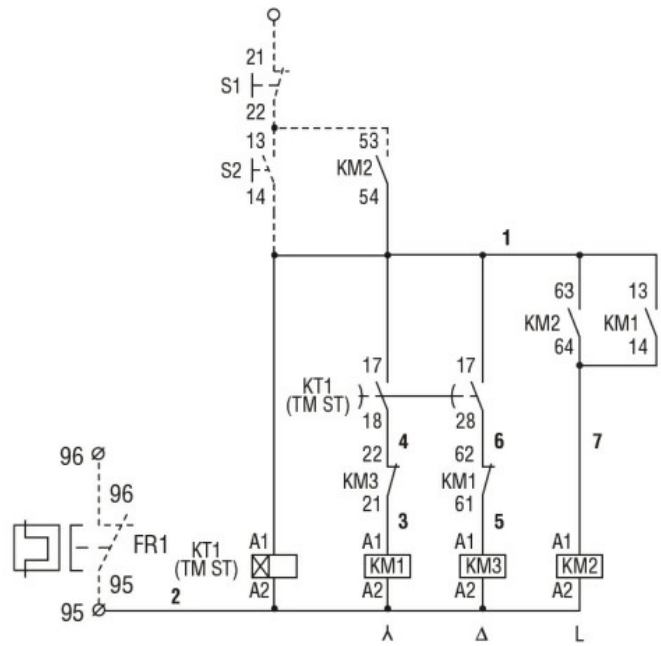
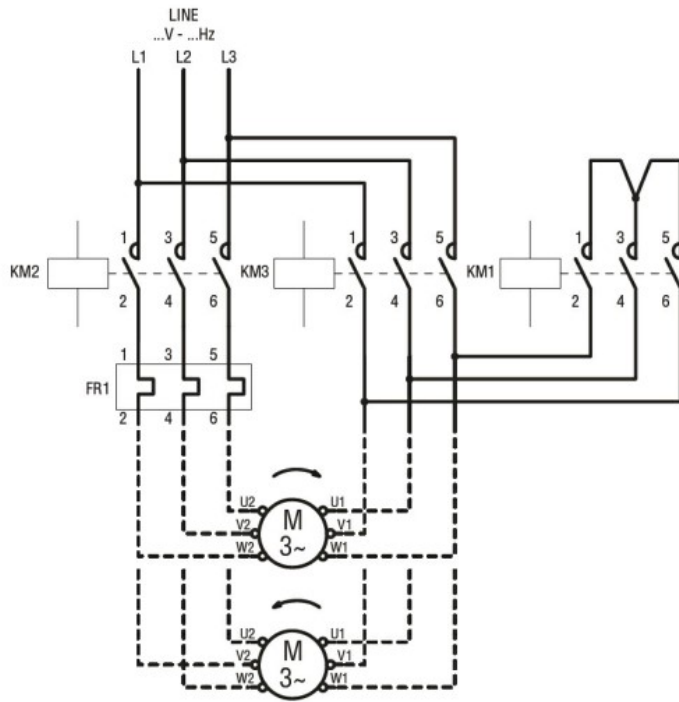

Certifications and compliance

Compliance

CSA C22.2 n° 14

for starters

IEC/EN 60947-1

IEC/EN 60947-4-1

UL508

Certificates

/

ETIM classification

ETIM 8.0

EC001037 -
Motor
starter/Motor
starter
combination