

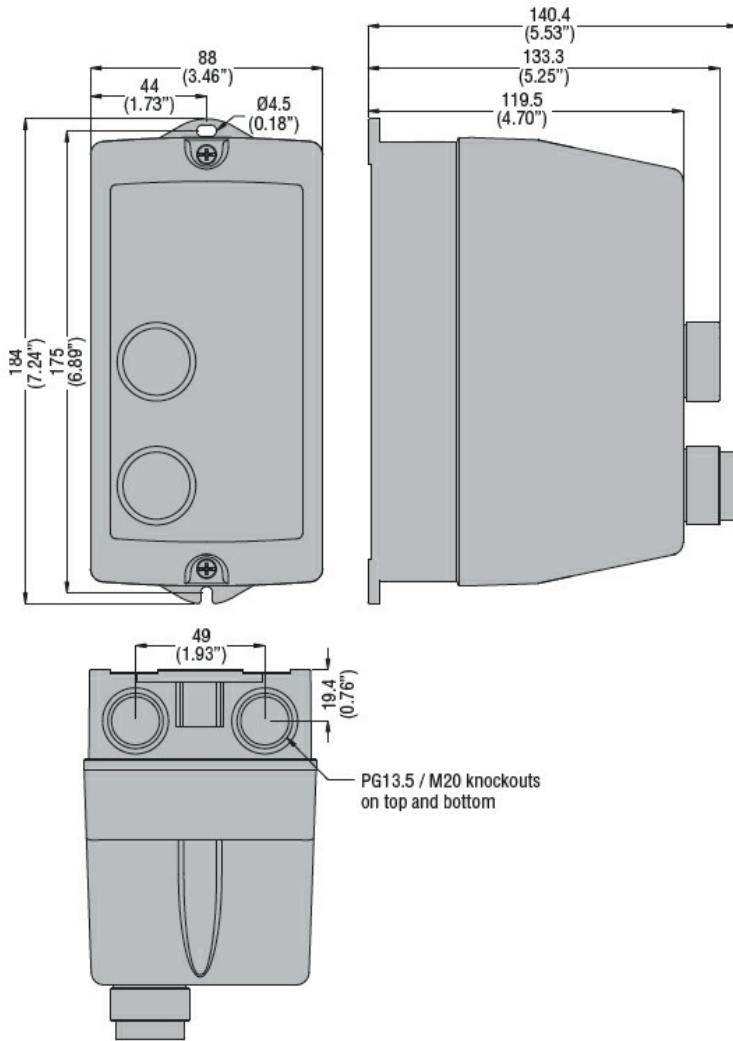

Product designation	Direct-on-line starter		
Product type designation	M0P00912...5		
Electrical features			
Relay adj range	A	4.5-7.5	
IEC technical characteristics ($\leq 440V$)			
	le	A	7.5
	kW	kW	2.2...3
Components			
Starter enclosure standard supplied	M0PA		
Contactor standard supplied	BG0910A		
Thermal relay standard supplied	RF975		
UL technical data			
Maximum UL/CSA horsepower ratings single-phase			
	220V-240V	HP	0.75
Maximum UL/CSA horsepower ratings three-phase, 3-pole			
	200V-208V	HP	1.5
	220V-240V	HP	2
	440V-480V	HP	5
	550V-600V	HP	5
Mechanical features			
Weight	g	760	
Ambient conditions			
Operating temperature			
	min	°C	-25
	max	°C	+60
Storage temperature			
	min	°C	-40
	max	°C	+70
Resistance & Protection			
Frontal IP degree	IP65		
Dimensions			



Wiring diagrams



I = Start; O = Stop/Reset

Certifications and compliance

Compliance

IEC/EN 60947-1
IEC/EN 60947-4-1
UL508 CSA C22.2 n° 14

Certificates

CSAus
cULus
EAC

ETIM classification

ETIM 8.0

EC001037 -
Motor
starter/Motor
starter
combination