

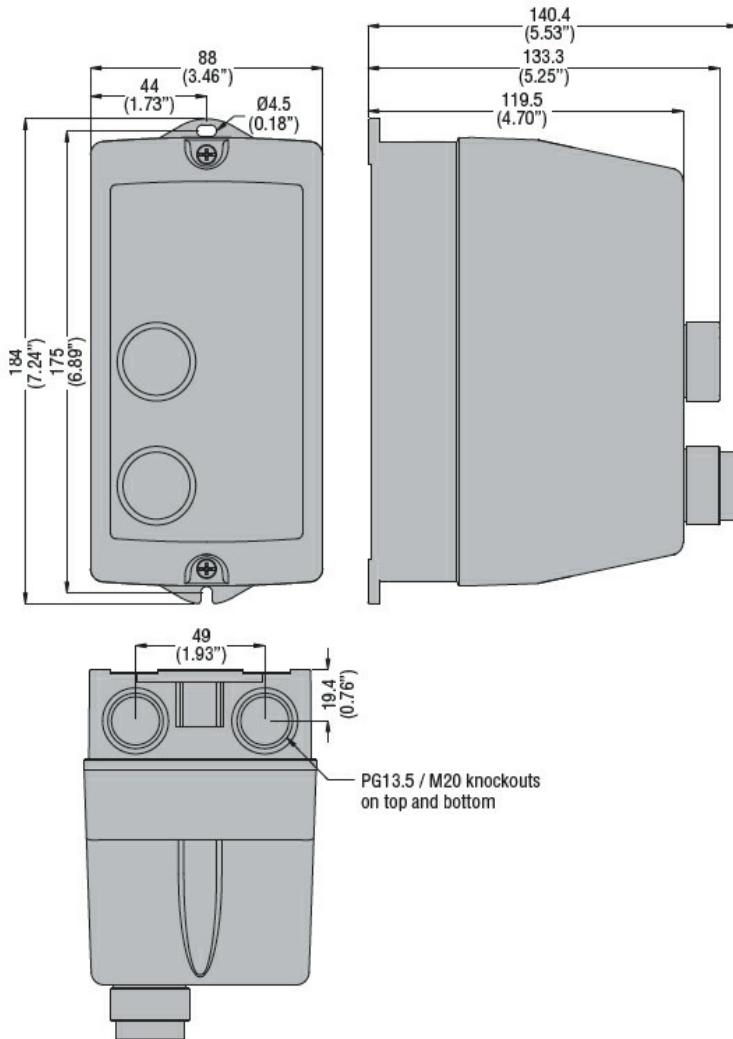

Product designation	Direct-on-line starter		
Product type designation	M0P00910		
<b>Electrical features</b>			
Maximum operating current ( $\leq 440V$ )	A	10	
<b>Components</b>			
Starter enclosure standard supplied	M0PA		
Contactor standard supplied	BG0910A		
Thermal relay to purchase separately	RF9...		
<b>Mechanical features</b>			
Weight	g	667	
<b>Ambient conditions</b>			
Operating temperature	min	°C	-25
	max	°C	+60
Storage temperature	min	°C	-40
	max	°C	+70
<b>Resistance &amp; Protection</b>			
Frontal IP degree	IP65		
<b>Dimensions</b>			

DIRECT-ON-LINE-STARTER, ENCLOSED WITHOUT THERMAL OVERLOAD RELAY, WITH START AND STOP/RESET BUTTONS, WITH BG09/BG12 CONTACTOR, 12A MAX ( $\leq 440V$ ), IP65. CONTACTOR COIL VOLTAGE 400VAC 50/60HZ



Wiring diagrams



I = Start; O = Stop/Reset

**Certifications and compliance**

Compliance

IEC/EN 60947-1  
IEC/EN 60947-4-1  
UL508 CSA C22.2 n° 14

Certificates

CSAus  
cULus  
EAC

**ETIM classification**

ETIM 8.0

EC001037 -  
Motor  
starter/Motor  
starter  
combination