

Product designation Star-delta starter  
Product type designation BFA065

**Electrical features**

Maximum operating current ( $\leq 440V$ ) A 140

**Components**

Contactor standard supplied BF8000A /  
BF8000A /  
BF5000A

Thermal relay standard supplied No

Thermal relay to purchase separately RF82

Auxiliary contact standard supplied BFX1020 /  
BFX1011 /  
BFX1011

**Contact characteristics**

IEC standard motor powers

230V	kW	45
400V	kW	75
440V	kW	75
500V	kW	90

**Mechanical features**

Weight g 6265

**Dimensions**

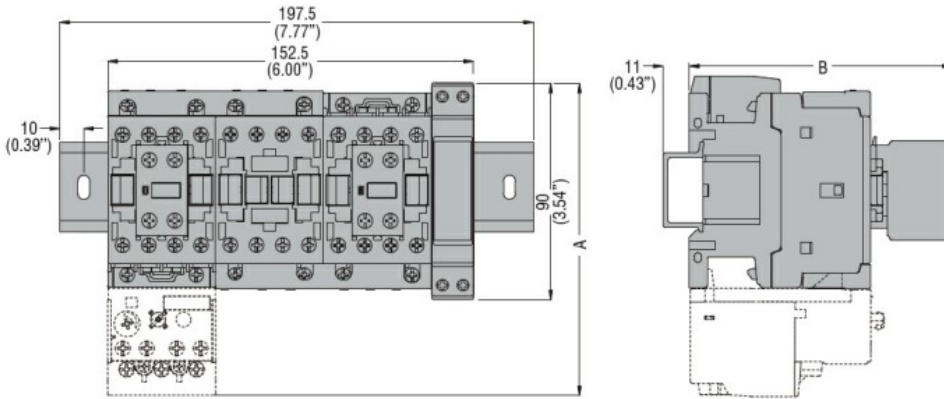

STARTER TYPE	A	B
BFA009 70	130.5 (5.14")	109.5 (4.31")
BFA012 70	130.5 (5.14")	109.5 (4.31")
BFA018 70	130.5 (5.14")	109.5 (4.31")
BFA025 70	130.5 (5.14")	109.5 (4.31")
BFA026 70	135 (5.14")	119 (4.68")
BFA032 70	135 (5.14")	119 (4.68")
BFA038 70	135 (5.14")	119 (4.68")
BFA050 70	173 (6.81")	142 (5.59")
BFA065 70	173 (6.81")	142 (5.59")
BFA080 70	183 (7.20")	142 (5.59")

**Wiring diagrams**



**Certifications and compliance**

Compliance

IEC/EN 60947-1  
IEC/EN 60947-4-9

Certificates

/

**ETIM classification**

ETIM 8.0

EC001037 -  
Motor  
starter/Motor  
starter  
combination