



Product designation	Star-delta starter
Product type designation	BFA018

Electrical features

Maximum operating current ($\leq 440V$)	A	28
---	---	----

Components

Contactor standard supplied	BF1810A / BF1801A / BF1210A
Thermal relay standard supplied	No
Thermal relay to purchase separately	RF38
Auxiliary contact standard supplied	BFX1020 // BFX1011

Contact characteristics

IEC standard motor powers	230V	kW	7.5
	400V	kW	15
	440V	kW	11
	500V	kW	11

Mechanical features

Weight	g	1700
--------	---	------

Dimensions

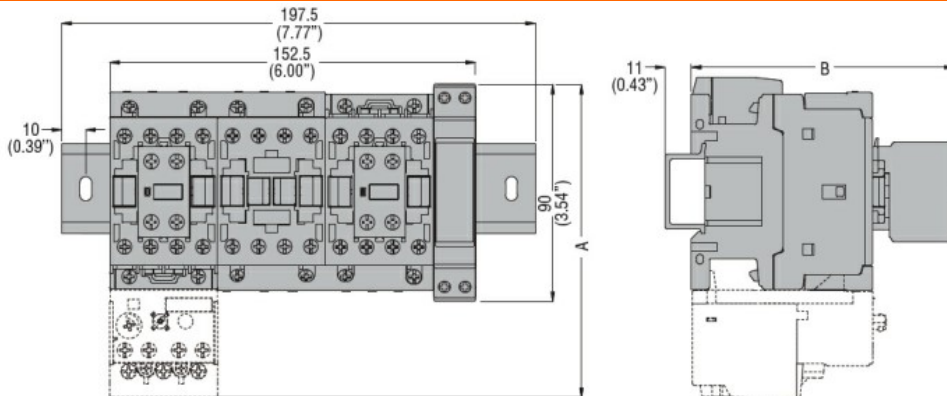

STARTER TYPE	A	B
BFA009 70	130.5 (5.14")	109.5 (4.31")
BFA012 70	130.5 (5.14")	109.5 (4.31")
BFA018 70	130.5 (5.14")	109.5 (4.31")
BFA025 70	130.5 (5.14")	109.5 (4.31")
BFA026 70	135 (5.14")	119 (4.68")
BFA032 70	135 (5.14")	119 (4.68")
BFA038 70	135 (5.14")	119 (4.68")
BFA050 70	173 (6.81")	142 (5.59")
BFA065 70	173 (6.81")	142 (5.59")
BFA080 70	183 (7.20")	142 (5.59")

Wiring diagrams

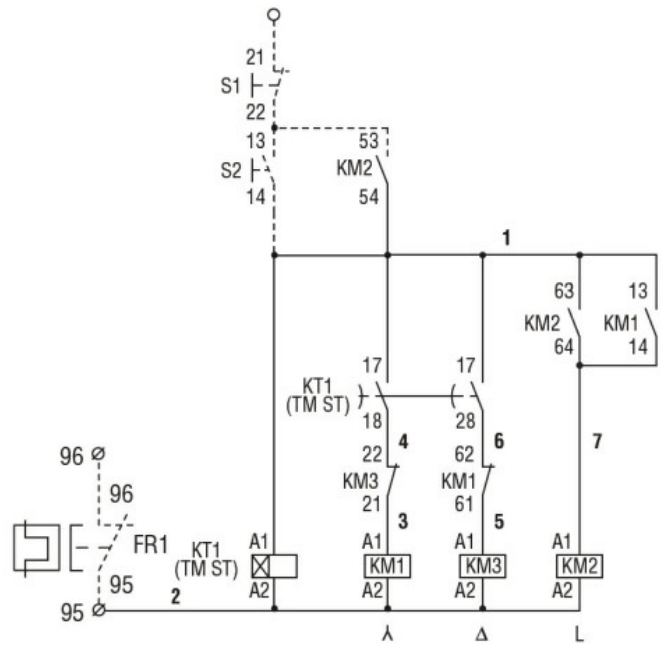
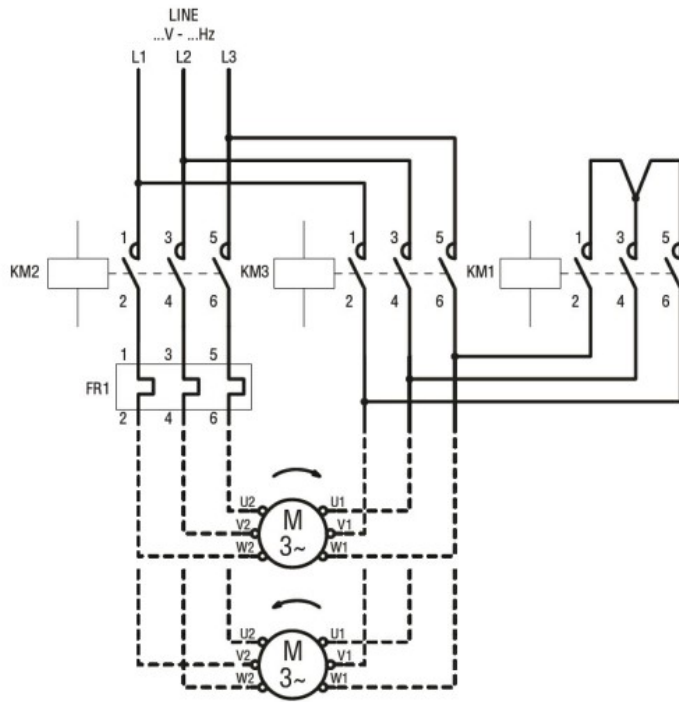

Certifications and compliance

Compliance

IEC/EN 60947-1
IEC/EN 60947-4-9

Certificates

/

ETIM classification

ETIM 8.0

EC001037 -
Motor
starter/Motor
starter
combination