

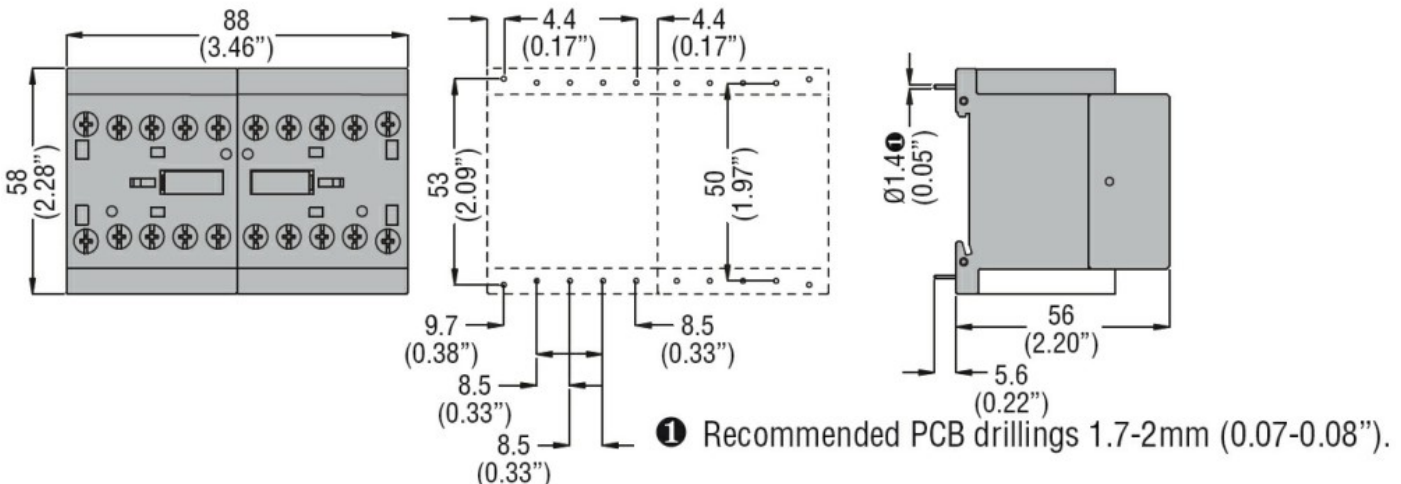

Product designation	Reversing contactor		
Product type designation	BGTP09		
Electrical features			
Maximum operating current ($\leq 440V$)	A	9	
Contact characteristics			
Operational current Ie	AC-3 ($\leq 440V \leq 55^{\circ}C$)	A	9
Rated operational power AC-3 ($T \leq 55^{\circ}C$)	230V	kW	2.2
	400V	kW	4
	415V	kW	4.3
	440V	kW	4.5
	500V	kW	5
Built-in auxiliary contacts	NO	0	
	NC	1	
UL technical data			
Maximum UL/CSA horsepower ratings single-phase	110V-120V	HP	0.5
	220V-240V	HP	1.5
Maximum UL/CSA horsepower ratings three-phase, 3-pole	200V-208V	HP	2
	220V-240V	HP	3
	440V-480V	HP	5
Mechanical features			
Terminals type	Clamp screw		
Weight	g	460	
Dimensions			

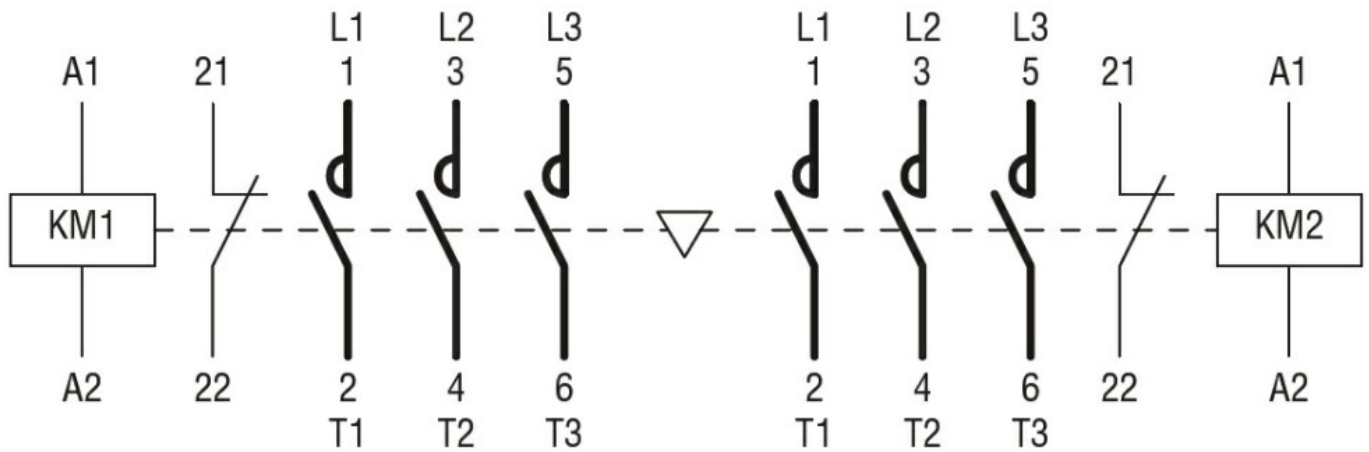

Wiring diagrams



Certifications and compliance

Compliance

IEC/EN 60947-1

IEC/EN 60947-4-1

UL508 CSA C22.2 n° 14

Certificates

cULus

ETIM classification

ETIM 8.0

EC001037 -
Motor
starter/Motor
starter
combination