

LOVATO ELECTRIC S.P.A.

24020 GORLE (BERGAMO) ITALIA
VIA DON E. MAZZA, 12
TEL. 035 4282111
FAX (Nazionale): 035 4282200
FAX (International): +39 035 4282400
E-mail info@LovatoElectric.com
Web www.LovatoElectric.com

WARNING! 

- Carefully read the manual before the installation or use.
- This equipment is to be installed by qualified personnel, complying to current standards, to avoid damages or safety hazards.
- Before any maintenance operation on the device, remove all the voltages from measuring and supply inputs and short-circuit the CT input terminals.
- The manufacturer cannot be held responsible for electrical safety in case of improper use of the equipment.
- Products illustrated herein are subject to alteration and changes without prior notice. Technical data and descriptions in the documentation are accurate, to the best of our knowledge, but no liabilities for errors, omissions or contingencies arising there from are accepted.
- A circuit breaker must be included in the electrical installation of the building. It must be installed close by the equipment and within easy reach of the operator. It must be marked as the disconnecting device of the equipment: IEC/EN 61010-1 § 6.11.2.
- Clean the instrument with a soft dry cloth; do not use abrasives, liquid detergents or solvents.

INDEX	Page
Manual revision history	1
Introduction	2
Description	2
Keyboard functions	3
Front LED indication	3
Operating modes	3
Power-up	4
Main menu	4
Password access	4
Display page navigation	4
Table of display pages	5
Harmonic analysis page	7
Waveform pages	7
User pages	7
Inputs, outputs, internal variables, counters	8
Limit thresholds	8
Remote-controlled variables	8
User alarms	8
PLC Logic	9
Automatic test	9
Sleep mode	9
CAN bus	9
IR programming port	11
Parameter setting through PC	11
Setting of parameters (setup) from front panel	11
Parameter table	13
Alarms	26
Alarm properties	26
Alarm table	27
Alarm description	28
Input function table	30
Output function table	31
Command menu	32
Installation	32
Wiring diagrams	33
Terminal arrangement	34
Mechanical dimensions	35
Panel protection	35
Technical characteristics	36

MANUAL REVISION HISTORY

REV	DATE	NOTES
00	24.03.2012	- First release
01	14.05.2012	- Specification of the correspondence between parameters of menu M19 programmable outputs n=1...7 to physical outputs OUT1, OUT2, OUT3, OUT4, OUT8, OUT9 and OUT10. - Description of parameter P22.13 Load shedding is better detailed. - Added description of command C25 Sleep mode (available from SW rev. 02).
03	02.10.2013	- Added description of mutual standby alarm - Modified command menu

INTRODUCTION

The RGK700 control unit has been designed to offer state-of-the-art functions for genset applications, both with and without automatic mains outage control. Built with dedicated components and extremely compact, the RGK700 combines the modern design of the front panel with practical installation and LCD screen that provides a clear and intuitive user interface.

DESCRIPTION

- Genset control with automatic management of mains-generator switching (RGK700) or remote starting management (RGK700SA).
- 128x80 pixel, backlit LCD screen with 4 grey levels
- 13 function and setting keys
- Built-in buzzer.
- 10 LEDs indicate operating modes and states
- 5-language text for measurements, settings and messages.
- Advanced programmable I/O functions.
- 4 alternative functions can be managed, selecting the same with a selector.
- Integrated PLC logic with thresholds, counters, alarms, states.
- Fully user-definable alarms.
- High accuracy TRMS measurement.
- 3-phase + neutral mains voltage reading input.
- 3-phase + neutral genset voltage reading input.
- 3-phase load currents reading input.
- 12-24 VDC universal battery power supply.
- Front optical programming interface: galvanically isolated, high speed, waterproof, USB and WiFi compatible.
- 3 analog inputs for resistive sensors:
 - Oil pressure:
 - Coolant temperature
 - Fuel level
- 7 digital inputs:
 - 6 programmable, negative
 - 1 for emergency-stop pushbutton, positive
- 7 digital outputs:
 - 4 protected positive static outputs
 - 3 relays
- Engine speed reading W and pick-up input
- CAN bus-J1939 engine ECU control communications interface.
- Storage of last 250 events.
- Support for remote alarms.

FRONT KEYBOARD

OFF, MAN, AUT and TEST keys - To choose function mode.

START and STOP keys - Only enabled and used to start and stop genset in MAN mode. Pressing the START key will attempt to start the machine in semiautomatic mode, while holding it down will maintain the start command in manual mode. The LED flashing on the engine symbol indicates the engine is running with the alarms inhibited, and fixed access at the end of the inhibit alarms time. The engine can be stopped immediately with the OFF key.

MAINS and GEN keys - Only enabled in MAN mode and used to switch the load from the mains to the generator and vice versa. The green LEDs lit near the mains and generator symbols indicate the respective voltages available within the preset limits. The LEDs lit near the switching symbols indicate the circuit breakers have been closed. They will flash if the circuit breakers closing or opening feedback signal does not correspond to the state of the command.

Key ✓ - Calls up the main menu and is also used to confirm choices.

Keys ▲ and ▼ - Used to scroll the pages of the display or select the list of options in a menu.

Key ◀ - Used to select the Mains or Generator measurements, or to decrease a number.

Key ▶ - Used to scroll sub-pages or increase a number.

FRONT LEDs

OFF, MAN, AUT and TEST LED (red) - Lit LED indicates active mode. If the LED flashes, remote control via serial interface is enabled (and therefore the operating mode could be changed by a remote command).

Engine running LED (green) - Indicates the engine is running. The RGK700 detects the state of the engine running on the basis of several signals (generator voltage/frequency, D+, AC, W, Pick-up, etc.). The LED lights when any one of these signals is present. The LED flashes when the engine is running, but the protections (Alarms) associated with this state have not been enabled, which is usually the case for a few seconds after starting.

Mains/generator voltage present LEDs (green) - When lit, these indicate that all the parameters of the respective power sources are within the limits. Any anomaly will immediately turn the LEDs off. The state of the LEDs instantaneously follows the voltage/frequency trend, without programmed delays.

Mains/generator load LEDs (yellow) - Indicate the load is connected to the respective power sources. These light when feedback signals are received if programmed, otherwise they light for output commands. If they are blinking, this indicates that the actual state of the circuit breaker (read through the feedback inputs) does not correspond to the state of the RGK700 command.

Alarm LED (red) - Flashing, indicates an active alarm.

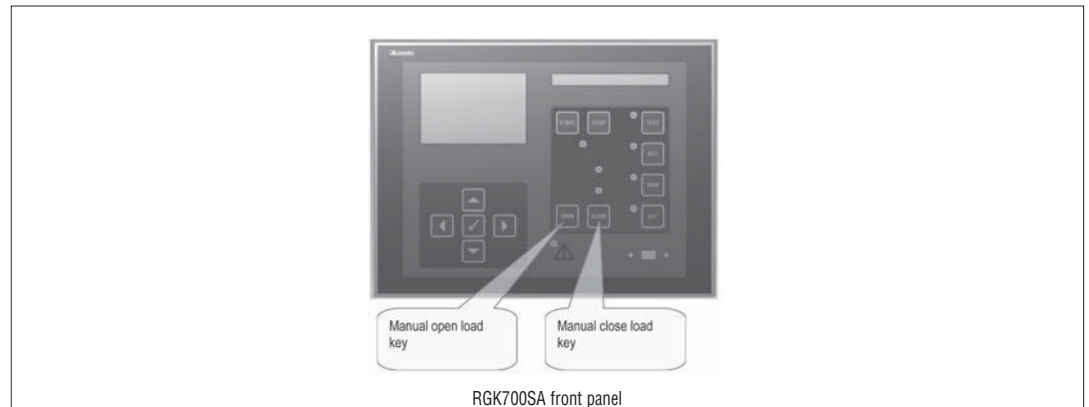
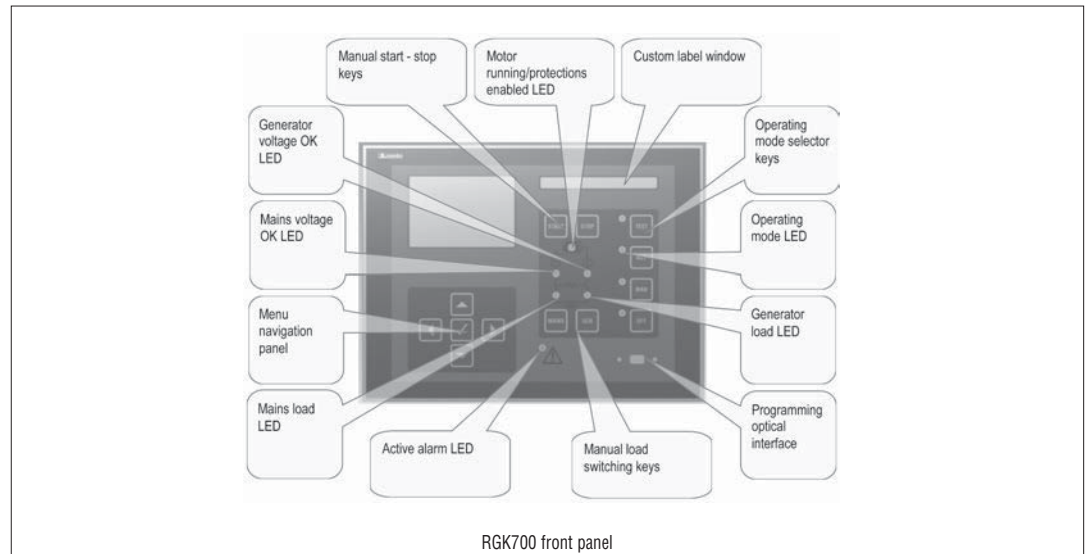

OPERATING MODES

OFF mode - The engine will not start. The engine will stop immediately when this mode is selected. The mains contactor is closed. This mode reproduces the state of the RGK700 when it is not powered. Use this system mode to program the parameters and open the commands menu. The siren is disabled in OFF mode.

MAN Mode - The engine can only be started and stopped manually using the START and STOP keys, as is the case for switching the load from the mains to the generator by pressing the MAINS/GEN keys and vice versa. Holding down the START key extends the set starting time. When START is pressed once, the generator will attempt to start in semiautomatic mode on the basis of the times set.

AUT Mode - The engine of the RGK700 is started automatically in the case of a mains outage (outside the set limits) and stops when the mains parameters are once again within said limits, on the basis of the times set in menu M13 Mains control. In the presence of voltage, the load is switched automatically in both directions.

The RGK700SA is started and stopped remotely through a digital input (remote starting) normally controlled by an ATS. The load can be switched automatically or controlled remotely.

For both models, if the engine fails to start, the system continues attempting to start the engine up to the maximum number of programmed attempts. If the automatic test is enabled, it runs at the preset times.

TEST Mode - The engine is started immediately even in the absence of the conditions normally required for the automatic mode. The engine starts in the programmed automatic mode. There is normally no load switching. If there is a mains outage while the RGK700 is in TEST mode, the load is switched to the generator. If mains voltage is restored, the load will remain switched to the generator until the operating mode is changed.

POWER-UP

- The system normally starts in OFF mode.
- If you want the operating mode used before the system powers down to be maintained, change parameter P01.03 in menu M01 Utility.
- The system can be powered at both 12 and 24 VDC, but the correct battery voltage must be set in menu M05 Battery, or a battery voltage alarm will be generated.
- The parameters of menu M02 General (type of connection, rated voltage, system frequency), menu M11 Engine Starting, and the menus for the type of engine used (sensors, CAN, etc.) should normally be set.

MAIN MENU

- The main menu is made up of a group of graphic icons (shortcuts) that allow rapid access to measurements and settings.
- Starting from normal viewing, press key. The main menu screen is displayed.
- Press to rotate clockwise/counter clockwise to select the required function. The selected icon is highlighted and the central part of the display shows the description of the function.
- Press to activate the selected function.
- If some functions are not available, the correspondent icon will be disabled, that is shown in a light grey colour.
- etc. - Shortcuts that allow jumping to the first page of that group. Starting from that page it is still possible to move forward-backward in the usual way.
- - Opens the password entry page, where it is possible to specify the numeric codes that unlock protected functions (parameter setting, commands menu).
- - Access point to the setup menu for parameter programming. See dedicated chapter.
- - Access point to the commands menu, where the authorised user can execute some clearing-restoring actions.

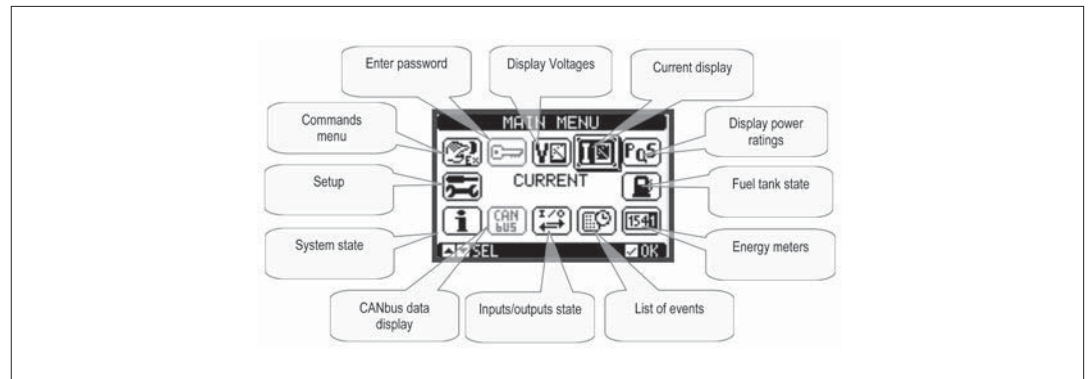

PASSWORD ACCESS

- The password is used to enable or lock the access to setting menu (setup) and to commands menu.
- For brand-new devices (factory default), the password management is disabled and the access is free. If instead the passwords have been enabled and defined, then to get access, it is necessary to enter the password first, specifying the numeric code through the keypad.
- To enable password management and to define numeric codes, see setup menu.
- There are two access levels, depending on the code entered:
 - **User-Level access** – Allows clearing of recorded values and the editing of a restricted number of setup parameters.
 - **Advanced access level** – Same rights of the user access plus full settings editing-restoring.
- From normal viewing, press to recall main menu, select the password icon and press .
- The display shows the screen in picture:

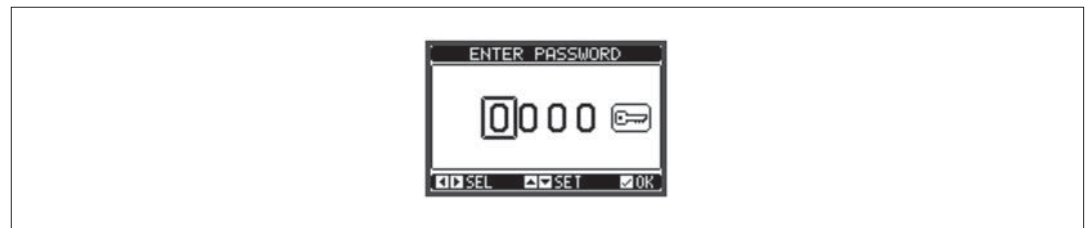





- Keys and change the selected digit
- Keys and move through the digits.
- Enter all the digits of the numeric code, then move on the key icon.
- If the password code entered matches the User access code or the Advanced access code, then the correspondent unlock message is shown.
- Once unlocked the password, the access rights last until:
 - the device is powered off.
 - the device is reset (after quitting the setup menu).
 - the timeout period of two minutes elapses without any keystroke.
- To quit the password entry screen press key.

DISPLAY PAGE NAVIGATION

- Keys and scroll through the measurements pages one by one. The title bar shows the current page.
- Some measurements may not be shown depending on the system programming and connections (for example if a fuel sensor is not set, the relevant page will not be shown).
- On some pages of the RGK700, the display can be switched from the mains measurements to the generator measurements and vice versa with key . The source displayed is always indicated, either in the middle of the page or by the icons **M** and **G** in the status bar.
- Sub-pages, which can be opened with key , are also available on some pages (displaying voltages and currents in the form of bar graphs, for example).
- The user can specify which page and which sub-page the display should return to automatically when no keys have been pressed for a certain time.
- The system can also be programmed so the display remains where it was last.
- You can set this function in menu M01 – Utility.

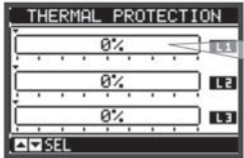
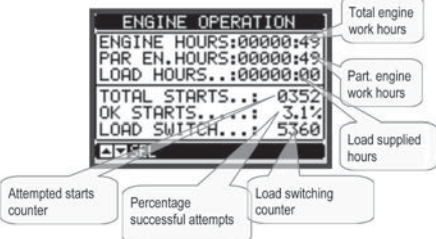
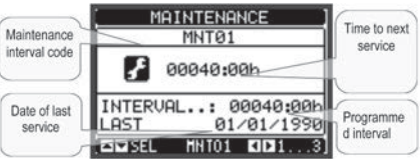
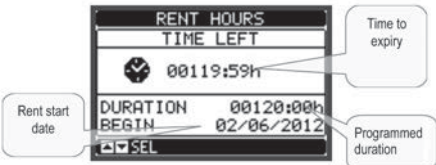
TABLE OF DISPLAY PAGES

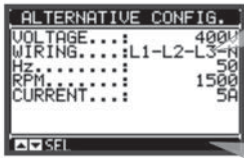
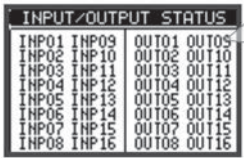
PAGES	EXAMPLE
Line-to-line voltages Phase voltages Current ... L-L voltage THD L-N voltage THD Current THD	<p>Unit of measure Phase indication Frequency Engine operating Battery voltage Fuel level Mains/Gen. ind. Oil pressure Coolant temperature</p>
L-L Voltages/Currents L-N Voltages/Currents	<p>Voltages Currents</p>
Active power Reactive power Apparent power Power factor	<p>Power per phase Total power Percentage of rated power Total power bar graph</p>
Energy meters	<p>Key ◀ switches between Mains and Generator (RGK800) Key ▶ switches between Total/Partial indications</p>
Summary of electrical measurements	<p>Mains/Gen. Ind. Phase indication Measurements indication Measurements values</p>
Engine speed Note: From this page it is possible to acquire automatically the ratio between RPM and W frequency. See description of parameter P07.02.	<p>Speed indicator Min. limit Max. limit</p>
Fuel level status	<p>Current level bar Total tank capacity Available fuel Quantity after filling Man. pump command Filling pump state</p>
Fuel autonomy	<p>Residual autonomy with present fuel rate from CAN Present fuel rate from CAN Residual autonomy with maximum fuel rate Maximum declared engine fuel rate</p>

PAGES	EXAMPLE
Generator thermal protection	 <p>Percentage of intervention value</p>
Engine hour and work counters	 <p>Total engine work hours Part. engine work hours Load supplied hours Load switching counter Percentage successful attempts Attempted starts counter</p>
Maintenance intervals	 <p>Maintenance interval code Time to next service Date of last service Programmed interval</p>
Rent	 <p>Time to expiry Rent start date Programmed duration</p>
List of events	 <p>Date and time of intervention Event code Description of event</p>
Alternative configurations	 <p>Present config. data Selected config. number</p>
I/O state	 <p>Digital I/O state In reverse = enabled</p>
Real time calendar clock	

PAGES	EXAMPLE
Info page	
System info	

Note: Some of the pages listed above may not be displayed if the relevant function is disabled. For example, if the rent function is not programmed, the corresponding page will not be shown.

HARMONIC ANALYSIS PAGE

- In the RGK700 it is possible to enable the calculation of the FFT harmonic analysis up to the 31st order of the following measurements:
 - phase-to-phase voltages
 - phase-to-neutral voltages
 - currents
- To enable the harmonic analysis, set parametr P23.14.
- For each of these measurements, there is a display page that graphically represents the harmonic content (spectrum) through a bar graph.
- Every column is related to one harmonic order, even and odd. The first column shows the total harmonic distortion (THD).
- Every histogram bar is then divided into three parts, one each phase L1, L2, L3.
- The value of the harmonic content is expressed as a percentage with respect to the fundamental (system frequency).
- It is possible to show the harmonic content in numeric format, selecting the required order through ◀ and ▶. The lower part of the screen will display a little arrow that points to the selected column, and the relative percentage value of the three phases.
- The vertical scale of the graph is automatically selected among four full-scale values, depending on the column with the highest value.

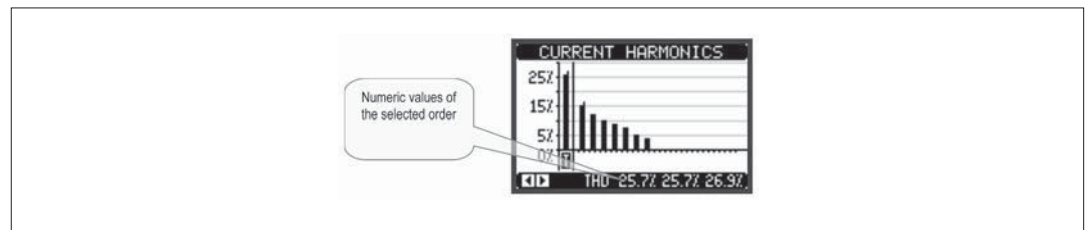

WAVEFORM PAGE

- This page graphically views the waveform of the voltage and current signals read by the RGK700.
- It is possible to see one phase at a time, selecting it with ◀ and ▶ key.
- The vertical scale (amplitude) is automatically scaled in order to fit the waveform on the screen in the best possible way.
- The horizontal axis (time) shows two consecutive periods referred to the fundamental frequency.
- The graph is automatically updated about every 1s.

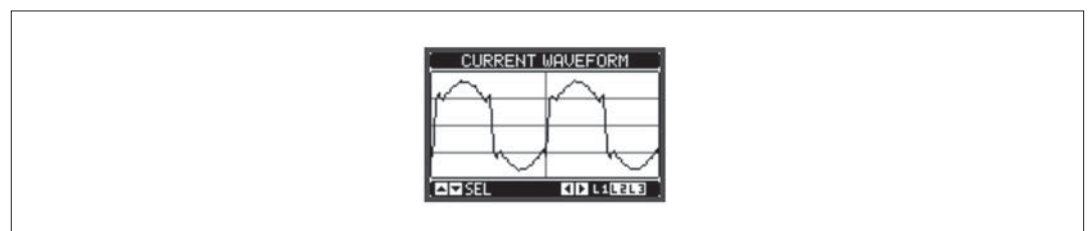

USER PAGES

- The user can create a maximum of 4 customised display pages.
- Each of these pages can view 3 measurements, freely chosen among the available readings of the RGK700.
- The title of the page can be freely programmed by the user.
- The user pages are placed in a position that allows to reach them easily starting from the first page, by pressing button ▲.
- Like all other pages, it is possible to set the system to return automatically to the user page after a time has elapsed without keystrokes.
- To define the user page, see the dedicated menu M26 User pages in the parameter setup chapter.

INPUTS, OUTPUTS, INTERNAL VARIABLES, COUNTERS, ANALOG INPUTS

- The inputs and outputs are identified by a code and a sequence number. For instance, the digital inputs are identified by code INPx, where x is the number of the input. In the same way, digital outputs are identified by code OUTx.

CODE	DESCRIPTION	BASE	EXP
INPx	Digital Inputs	1...8	—
OUTx	Digital Outputs	1...7	—
COMx	Communication ports	1	—
RALx	Remote relays for Alarm / status	—	1...24

- In a similar way, there are some internal bit-variables (markers) that can be associated to the outputs or combined between them. For instance, it is possible to apply some limit thresholds to the measurements done by the system (voltage, current, power, etc.). In this case, an internal variable named LIMx will be activated when the measurements will go outside the limits defined by the user through the dedicated setting menu.
- Furthermore, there are up to 4 counters (CNT1..CNT4) that can count pulses coming from an external source (through a digital input INPx) or the number of times that a certain condition has been verified. For instance, defining a limit threshold LIMx as the count source, it will be possible to count how many times one measurement has exceeded a certain limit.
- The following table groups all the I/O and the internal variables managed by the RGK700.

CODE	DESCRIPTION	RANGE
LIMx	Limit thresholds	1...16
REMX	Remote-controlled variables	1...16
UAX	User alarms	1...8
PULx	Energy consumption pulses	1...6
CNTx	Programmable counters	1...4
PLCx	PLC logic variables	1...32

LIMIT THRESHOLDS (LIMX)

- The LIMn thresholds are internal variables whose status depends on the out-of-limits of one particular measurement set by the user (e.g. total active power higher than 25kW) among all those measured.
- To make the setting of the thresholds easier, since the limits can span in a very wide range, each of them can be set using a base number and a multiplier (for example: 25 x 1k = 25000).
- For each LIM, there are two thresholds (upper and lower). The upper threshold must always be set to a value higher than the lower threshold.
- The meaning of the thresholds depends on the following functions:

Min function: the lower threshold defines the trip point, while the upper threshold is for the resetting. The LIM trips when the selected measurement is less than the Lower threshold for the programmed delay. When the measured value becomes higher than the upper setpoint, after the set delay, the LIM status is reset.

Max function: the upper threshold defines the trip point, while the lower threshold is for the resetting. The LIM trips when the selected measurement is more than upper threshold for the programmed delay. When the measured value decreases below the lower setpoint, after the delay, the LIM status is reset.

Max+Min function: both thresholds are for tripping. When the measured value is less than lower or more than upper setpoints, then, after the respective delays, the LIM will trip. When the measured value returns within the limits, the LIM status will be immediately reset.

- Trip denotes either activation or deactivation of the LIM variable, depending on 'Normal status' setting.
- If the LIMn latch is enabled, the reset can be done only manually using the dedicated command in the commands menu.
- See setup menu M24.

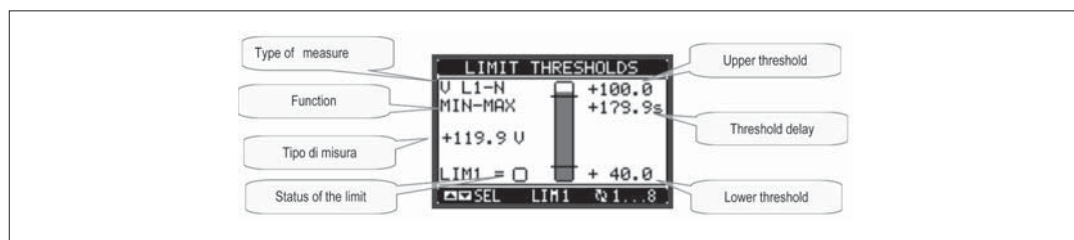

REMOTE-CONTROLLED VARIABLES (REMX)

- RGK700 can manage up to 16 remote-controlled variables (REM1...REM16).
- Those are variables which status can be modified by the user through the communication protocol and that can be used in combination with outputs, Boolean logic, etc.
- Example: using a remote variable (REMX) as a source for an output (OUTx), it will be possible to freely energise or de-energise one relay through the supervision software. This allows to use the RGK700 relays to drive lighting or similar loads.
- Another possible use of REM variables is to enable/disable other functions remotely, inserting them into a Boolean logic in AND with inputs or outputs.

USER ALARMS (UAX)

- The user has the possibility to define a maximum of 8 programmable alarms (UA1...UA8).
- For each alarm, it is possible to define:
 - the source that is the condition that generates the alarm,
 - the text of the message that must appear on the screen when this condition is met.
- The properties of the alarm (just like for standard alarms), that is in which way that alarms interacts with the generator control.
- The condition that generates the alarm can be, for instance, the overcoming of a threshold. In this case, the source will be one of the limit thresholds LIMx.
- If instead, the alarm must be displayed depending on the status of an external digital input, then the source will be an INPx.
- With the same criteria, it is possible to also link complex conditions to an alarm, resulting from the logic combination of inputs, limits, etc. In this case, the Boolean logic variables PLCx must be used.
- For every alarm, the user can define a free message that will appear on the alarm page.
- The properties of the user alarms can be defined in the same way as the normal alarms. You can choose whether a certain alarm will stop the engine, activate the siren, close the global alarm output, etc. See chapter Alarm properties.
- When several alarms are active at the same time, they are displayed sequentially, and their total number is shown on the status bar.
- To reset one alarm that has been programmed with latch, use the dedicated command in the commands menu.
- For details on alarm programming and definition, refer to setup menu M32.

PLC LOGIC (PLCX)

- You can set a ladder program with the Customisation manager software for the RGK PLC logic, to easily create any function required for the genset accessory applications.
- You can enter all the variables managed by the RGK700 in the program logic, such as inputs (INPx), limit thresholds (LIMx), remote variables (REMX), and controller states (RALx), etc.
- The results of processing the various branches of the ladder logic are saved in internal variables (PLCx) which can then be used to control the outputs of the RGK700, or as backup memories to build a more complex logic, or also to control user-defined alarms (UAX).
- The logic function created with the ladder program can be verified in real time and if necessary corrected in the relevant window of the Customisation manager.

AUTOMATIC TEST

- The automatic test is a periodic test carried out at set intervals (set during setup) if the system is in AUT mode and the function has been enabled.
- It is possible to decide in which days of the week the automatic test can be executed and at what time of the day (hours:minutes).
- See menu M16 Automatic test for more details on automatic test programming.
- After starting, the genset runs for a set time, after which it will stop. The message 'T.AUT' is displayed before the generator starts.
- The automatic test can be set to run in setup also if there is an external stop signal.



- The automatic test can be enabled/disabled without opening the Setup menu in the following way:
 - Open the 'AUTOMATIC TEST' page and press the keys ◀ and START to enable the function, or the keys ◀ and STOP to disable it.
- The automatic test can be stopped with the OFF key.

SLEEP MODE

- The sleep mode allows the RGK to enter a low battery consumption mode, where current sink is reduced to about ...mA.
- To enter sleep mode, use command C25 in command menu.
- The back light is turned off and the display shows sleep icon. Led OFF flashes slowly.
- In this mode the RGK act like it is powered off.
- To quit sleep mode and go back to normal operation, press OFF button.

CANBUS

- The CAN port allows RGK700 controllers to be connected to the electronic control units (ECU) of modern engines in order to:
 - Read the measurements contained in the ECU without adding sensors to the engine
 - Considerably simplify wiring
 - Obtain complete, detailed diagnostics
 - Avoid assembly of CIU or Co (coordinator) type decoding boards
 - Permit direct control from CAN of engine stopping and starting (where permitted)
- The board functions in combination with the ECUs of the engines most widely used in gensets applications, using the standard defined by the SAE J1939.
- For details on CAN parameters, see setup menu M21 CANBUS.

SUPPORTED MEASUREMENTS

- The CAN port is able to decode and make available a set of measurements defined by the J1939 standard and identified by a number (SPN, Suspect Parameter Number).
- According to the type of engine, a certain number of measurements are available (a sub-set of possible measurements) that are shown on the display of the RGK700.
- The measures are grouped in several sub-pages, that can be viewed pressing ◀ and ▶ keys.

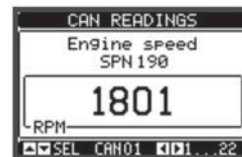

- The next page shows the diagnostic messages.
- Engine speed, oil pressure and cooling fluid temperature are taken directly from the CAN; therefore, neither wiring or setting of the related sensors is required.

SPN	Description	U/M
190	Engine speed	RPM
100	Oil pressure	Bar
110	Coolant temperature	°C
247	ECU engine hours	h
102	Boost pressure	Bar
105	Intake manifold temperature	°C
183	Fuel rate	l/h
513	Actual torque	%
512	Demand torque	%
91	Accelerator pedal position	%
92	Load percentage	%
-	Protection indicator	On-Off
-	Amber warning indicator	On-Off
-	Red alarm indicator	On-Off
-	Malfunction indicator	On-Off
174	Fuel temperature	°C
175	Oil temperature	°C
94	Fuel delivery pressure	Bar
98	Oil level	%
101	Crankcase pressure	Bar
109	Coolant pressure	Bar
111	Coolant level	%
97	Water in fuel	On-Off
158	Battery voltage	VDC
106	Air intake pressure	Bar
108	Barometric pressure	Bar
173	Exhaust gas temperature	°C

- When the ECU is off, the measurements are not available and are therefore replaced by hyphens.
- If a measurement is not available on a particular engine, NA (Not Available) is displayed.
- If a measurement is incorrect (for example, the sensor is disconnected) ERR is displayed instead of this.

DIAGNOSTICS

- In the case of failures, many ECUs highlight the problem with a J1939 standard code, called DTC (Diagnostic Trouble Code) consisting of SPN+FMI, where SPN (Suspect Parameter Number) identifies the signal affected by the fault, while FMI (Failure Mode Indicator) identifies the type of failure.
For example:
 SPN-FMI
 100-01
indicates SPN 100 (oil pressure) and FMI 01 (too low).
- In view of the many sensors connected to an ECU, a high number of possible codes is managed. In the case of a fault, this is indicated on the display of the RGK700 with both a code and with a description in the related language, in the last of the sub-pages dedicated to the CAN.
- In the case of several simultaneous alarms, these are cycled periodically.
- According to the seriousness of the code, an amber alarm indicator (warning) or red alarm indicator (critical alarm) is usually generated.
- Some ECUs do not use the J1939 standard to code the alarms. Also in this case, the DTCs are displayed with their numeric code and, when possible, with an uncoded description.
- To reset the alarms, press **✓** or **OFF**, as usual.
- If enabled, the RGK700 will send a reset alarm command, according to the type of ECU selected, on the BUS.

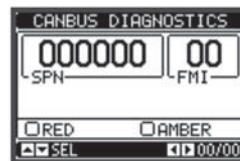

IR PROGRAMMING PORT

- The parameters of the RGK700 can be configured through the front optical port, using the IR-USB CX01 programming dongle, or with the IR-WiFi CX02 dongle.
- This programming port has the following advantages:
 - You can configure and service the RGK700 without access to the rear of the device or having to open the electrical board.
 - It is galvanically isolated from the internal circuits of the RGK700, guaranteeing the greatest safety for the operator.
 - High speed data transfer.
 - Ip65 front panel.
 - Limits the possibility of unauthorized access with device config.
- Simply hold the CX... dongle up to the front panel, connecting the plugs to the relevant connectors, and the device will be acknowledged as shown by the LINK LED on the programming dongle flashing green.



PARAMETER SETTING (SETUP) WITH PC

- You can use the Customization manager set-up software to transfer (previously programmed) set-up parameters from the RGK700 to the hard drive of the PC and vice versa.
- The parameter may be partially transferred from the PC to the RGK, transferring only the parameters of the specified menus.
- The PC can be used to set parameters and also the following:
 - Data on the characteristics of the pressure, temperature, fuel level sensor curves, and the generator protection
 - Customised logo displayed on power-up and every time you exit keyboard setup.
 - Info page where you can enter application information, characteristics, data, etc.
 - PLC logic debug and programming.
 - Load alternative set of languages to default.

PARAMETER SETTING (SETUP) FROM FRONT PANEL

- To open the parameters programming menu (setup):
 - Turn the unit in **OFF** mode.
 - In normal measurements view, press **✓** to call up the main menu.
 - Select the icon . If it is disabled (displayed in grey) you must enter the password (see chapter Password access).
 - Press **✓** to open the setup menu.
- The table shown in the illustration is displayed, with the settings sub-menus of all the parameters on the basis of their function.
- Select the required menu with keys **▲ ▼** and confirm with **✓**.
- Press **OFF** to return to the valves view.

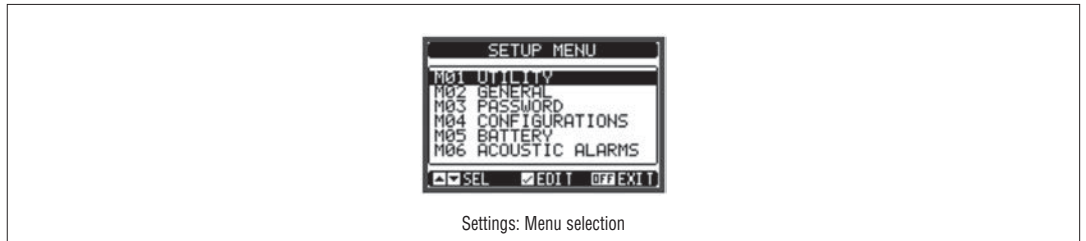

- The following table lists the available submenus:

CODE	MENU	DESCRIPTION
M01	UTILITY	Language, brightness, display pages, etc.
M02	GENERAL	System specifications
M03	PASSWORD	Password settings
M04x	CONFIGURATIONS	1..4 multiple configurations selectable
M05	BATTERY	Genset battery parameters
M06	ACOUSTIC ALARMS	Internal buzzer and external siren control
M07	ENGINE SPEED	Limit thresholds, rpm valve source
M08	OIL PRESSURE	Limit thresholds, valve source
M09	COOLANT TEMP.	Limit thresholds, valve source
M10	FUEL LEVEL	Filling, limit thresholds, measurement source
M11	ENGINE STARTING	Engine start/stop mode
M12	LOAD SWITCHING	Load switching mode
M13	MAINS CONTROL	Mains voltage limits of acceptability
M14	GEN CONTROL	Generator voltage limits of acceptability
M15	GEN PROTECTION	Ground-fault, protection curves, thresholds
M16	AUTOMATIC TEST	Automatic test mode, duration, period
M17	MAINTENANCE	Maintenance intervals
M18	PROG. INPUTS	Programmable digital inputs functions
M19	PROG. OUTPUTS	Programmable digital outputs functions
M20	COMMUNICATION	Address, format, protocol
M21	CAN BUS	ECU type, control options
M22	LOAD MANAGEMENT	Priority loads, dummy load management
M23	MISCELLANEOUS	Mutual stand-by, EJP, function, etc.
M24	LIMIT THRESHOLDS	Customisable limit thresholds
M25	COUNTERS	Programmable generic counters
M26	USER PAGES	Custom page dimensions
M27	REMOTE ALARMS	External relay alarm/state signals
M31	ENERGY PULSES	Energy metering pulses
M32	USER ALARM	Programmable alarms
M33	ALARM PROPERTIES	Alarms effect enabling

- Select the sub-menu and press ✓ to show the parameters.
- Each parameter is shown with code, description and actual setting value.

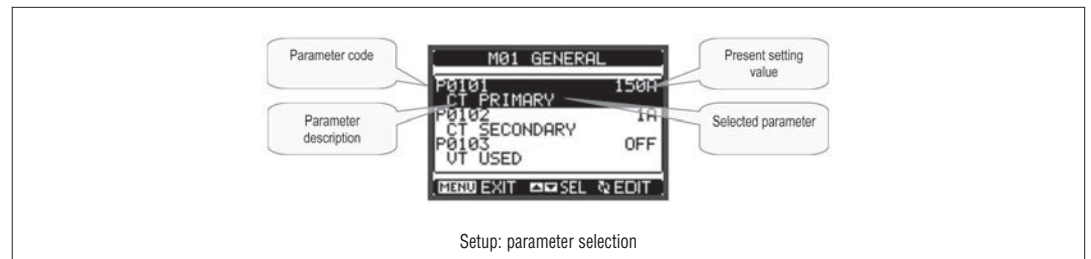

- To modify the setting of one parameter, select it and then press ✓.
- If the Advanced level access code has not been entered, it will not be possible to enter editing page and an access denied message will be shown.
- If instead the access rights are confirmed, then the editing screen will be shown.

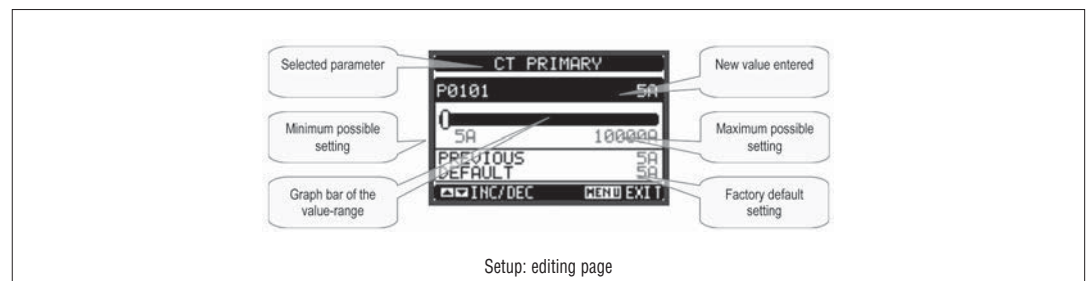

- When the editing screen is displayed, the parameter setting can be modified with ◀ and ▶ keys. The screen shows the new setting, a graphic bar that shows the setting range, the maximum and minimum values, the previous setting and the factory default.
- Pressing ◀ + ▲ the value is set to the minimum possible, while with ▲ + ▶ it is set to the maximum.
- Pressing simultaneously ◀ + ▶, the setting is set to factory default.
- During the entry of a text string, keys ▲ and ▼ are used to select the alphanumeric character while ◀ and ▶ are used to move the cursor along the text string. Pressing keys ▲ and ▼ simultaneously will move the character selection straight to character 'A'.
- Press ✓ to go back to the parameter selection. The entered value is stored.
- Press **OFF** to save all the settings and to quit the setup menu. The controller executes a reset and returns to normal operation.
- If the user does not press any key for more than 2 minutes, the system leaves the setup automatically and goes back to normal viewing without saving the changes done on parameters.
- N.B.: A backup copy of the setup data (settings that can be modified using the keyboard) can be saved in the eeprom memory of the RGK700. This data can be restored when necessary in the work memory. The data backup 'copy' and 'restore' commands can be found in the commands menu.

TABLE OF PARAMETERS

M01 - UTILITY		U/M	Default	Range
P01.01	Language		English	English Italiano Francais Español Portuguese
P01.02	Set power delivery clock		OFF	OFF-ON
P01.03	Power-on operating mode		OFF mode	OFF mode Previous
P01.04	LCD contrast	%	50	0-100
P01.05	Display CAN bus e intensity high	%	100	0-100
P01.06	Display CAN bus e intensity low	%	25	0-50
P01.07	Time to switch to low backlighting	s	180	5-600
P01.08	Return to default page	s	300	OFF / 10-600
P01.09	Default page		VLL	(page list)
P01.10	Generator identifier		(empty)	String 20 chr.

P01.01 – Select display text language.

P01.02 – Active automatic clock settings access after power-up.

P01.03 – Start system in OFF mode after power-up or in same mode it was switched off in.

P01.04 – Adjust LCD contrast.

P01.05 – Display backlight high adjustment.

P01.07 – Display backlight low delay.

P01.08 – Default page display restore delay when no key pressed. If set to OFF the display will always show the last page selected manually.

P01.09 – Default page displayed on power-up and after delay.

P01.10 – Free text with alphanumeric identifier name of specific generator. Used also for identification after remote reporting alarms/events via SMS/Email.

M02 – MAIN MENU		U/M	Default	Range
P02.01	Nos. 1-2-3 CT Primary	A	5	1-10000
P02.02	Nos. 1-2-3 CT Secondary	A	5	1-5
P02.03	Nos. 1-2-3 CT Current valve		Load	Load Generator
P02.07	VT Use		OFF	OFF-ON
P02.08	VT Primary	V	100	50-50000
P02.09	VT Secondary	V	100	50-500
P02.10	Phase sequence control		OFF	OFF L1-L2-L3 L3-L2-L1

P02.01 – Value of the phase current transformers primary. Example: set 800 for 800/5 CT.

P02.02 – Value of the phase current transformers secondary. Example: set 5 for 800/5 CT.

P02.03 – Positioning of phase CT. If positioned on load, the current (and the relative power and energy) are switched to the mains or generator on the basis of which circuit breaker is closed.

P02.07 – Using voltage transformers (TV) on mains/generator voltage metering inputs.

P02.08 – Primary value of any voltage transformers.

P02.09 – Secondary value of any voltage transformers.

P02.10 – Enable phase sequence control. **OFF** = no control. **Direct** = L1-L2-L3.

Reverse = L3-L2-L1. Note: Enable also corresponding alarms.

M03 - PASSWORD		U/M	Default	Range
P03.01	Use password.		OFF	OFF-ON
P03.02	User level password		1000	0-9999
P03.03	Advanced level password		2000	0-9999
P03.04	Remote access password		OFF	OFF/1-9999

P03.01 – If set to OFF, password management is disabled and anyone has access to the settings and commands menu.

P03.02 – With P03.01 enabled, this is the value to specify for activating user level access. See Password access chapter.

P03.03 – As for P03.02, with reference to Advanced level access.

P03.04 – If set to a numeric value, this becomes the code to specify via serial communication before sending commands from a remote control.

M04 – CONFIGURATIONS (CNFn, n=1...4)		U/M	Default	Range
P04.n.01	Rated voltage	V	400	50-500000
P04.n.02	Type of connection		L1-L2-L3-N	L1-L2-L3-N L1-L2-L3 L1-N-L2 L1-N
P04.n.03	Type of voltage control		L-L	L-L L-N L-L + L-N
P04.n.04	Rated current	A	5	1-10000
P04.n.05	Rated frequency	Hz	50	50 60
P04.n.06	Rated engine rpm	RPM	1500	750-3600
P04.n.07	Rated active power	kW	Aut	Aut / 1-10000
P04.n.08	Rated apparent power	kVA	Aut	Aut / 1-10000

Note: This menu is divided into 4 sections, which refer to 4 configurations CNF1...CNF4. See relevant chapter on managing the variable configurations.

P04.n.01 – Rated voltage of mains and generator. Always set the line-to-line voltage for polyphase systems

P04.n.02 – Choice of the type of connection, 3-phase with/without neutral, 2-phase or single phase.

P04.n.03 – Voltage controls performed on line-to-line voltages, phase voltages or both.

P04.n.04 – Rated current of the generator. Used for the percentage settings of the protection thresholds.

P04.n.05 – Rated frequency of mains and generator.

P04.n.06 – Rated engine rpm.

P04.n.07 – Rated active power of the generator. Used for the percentage settings of the protection thresholds, dummy load management, priority loads, etc. Ifset to Aut, it is calculated using the CT primary and rated voltage.

P04.n.08 – Rated apparent power of the generator.

M05 - BATTERY		U/M	Default	Range
P05.01	Battery rated voltage	V	12	12 / 24
P05.02	MAX. voltage limit	%	130	110-140%
P05.03	MIN. voltage limit	%	75	60-130%
P05.04	MIN./MAX. voltage delay	s	10	0-120

P05.01 – Rated battery voltage.

P05.02 – Battery MAX. voltage alarm intervention threshold.

P05.03 – Battery MIN. voltage alarm intervention threshold.

P05.04 – Battery MIN. and MAX. alarms intervention delay.

M06 – ACOUSTIC ALARMS		U/M	Default	Range
P06.01	Siren mode for alarm.		Time	OFF Keyboard Time Repeat
P06.02	Siren activation time for alarm.	S	30	OFF/1-600
P06.03	Siren activation time before starting.	S	OFF	OFF / 1-60
P06.04	Siren activation time for emote control initialisation.	S	OFF	OFF / 1-60
P06.05	Siren activation time for mains outage.	S	OFF	OFF / 1-60
P06.06	Acoustic warning devices		BUZZER+SIREN	OFF SIREN BUZZER BUZZER+SIR
P06.07	Buzzer for key press	s	0.15	OFF / 0.01-0.50

P06.01 – **OFF** = siren disabled. **Keyboard** = Siren goes off continuously until silenced by pressing a key on the front panel. **Timed** = Activated for the specified time with P06.02. **Repeated** = Activated for time P06.02, pause for 3x time, then repeated periodically.

P06.02 – Duration of buzzer activation for alarm.

P06.03 – Duration of buzzer activation before engine start.

P06.04 – Duration of buzzer activation after remote control via communication channel.

P06.05 – Duration of buzzer activation after mains outage.

P06.06 – Select buzzer.

P06.07 – Activation and duration of buzzer for key press.

M07 – ENGINE SPEED		U/M	Default	Range
P07.01	Engine speed reading source		W	OFF FREQ-GEN. W Pick-up LS Pick-up HS CAN
P07.02	RPM/W ratio – pick-up		1.000	0.001-50.000
P07.03	MAX. speed limit		110	100-120
P07.04	MAX. speed alarm delay		3.0	0.5-60.0
P07.05	MIN. speed limit		90	80-100
P07.06	MIN. speed alarm delay		5	0-600

- P07.01** – Select source for engine speed readings. **OFF** = rpm not displayed and controlled. **Freq. Gen** = RPM calculated on the basis of power alternator frequency. Rated rpm corresponds to rated frequency. **W** = RPM measured using the frequency of signal W, with reference to RPM/W ratio set with the following parameter. **Pick-up LS** = RPM measured by pick-up sensor, using a low sensitivity input (for strong signals). **Pick-up HS** = as above, with high-sensitivity input (for weak signals). **CAN** = RPM read by engine ECU through CAN bus.
- P07.02** – Ratio between the RPM and the frequency of the W or pick-up signal. Can be set manually or acquired automatically through the following procedure: From the engine speed page, with engine running at nominal speed, press **START** and **✓** together for 5 seconds. The system will acquire the present speed as the rated one, using the present frequency of the W signal to calculate the value of parameter P07.02.
- P07.03** – **P07.04** – Limit threshold and delay for generating engine speed too high alarm.
- P07.05** – **P07.06** – Limit threshold and delay for generating engine speed too low alarm.

M08 – OIL PRESSURE		U/M	Default	Range
P08.01	Reading source		OFF	OFF RES CAN
P08.03	Type of resistive sensor		VDO	VDO VEGLIA DATCON CUSTOM ...
P08.04	Resistive sensor offset	Ohm	0	-30.0 - +30.0
P08.05	Pressure units of measurement		bar	bar psi
P08.06	MIN. pressure prealarm	(bar/psi)	3.0	0.1-180.0
P08.07	MIN. pressure alarm limit	(bar/psi)	2.0	0.1-180.0

- P08.01** – Specifies which source is used for reading the oil pressure. **OFF** = not managed. **RES** = Read from resistive sensor with analog input on PRESS terminal. **CAN** = Read from CANbus.
- P08.03** – When using a resistive sensor, selects which curve to use. The curves can be custom set using the Customisation Manager software.
- P08.04** – When using a resistive sensor, this lets you add or subtract an offset in Ohms from the set curve, to compensate for cable length for example. This value can also be set without opening setup by using the quick function in the commands menu which lets you view the measurements while calibrating.
- P08.05** – Selects the unit of measurement for the oil pressure.
- P08.06** – **P08.07** – Define respectively the prealarm and alarm thresholds for MIN. oil pressure. See respective alarms.

M09 – COOLANT TEMPERATURE		U/M	Default	Range
P09.01	Reading source		OFF	OFF RES CAN
P09.03	Type of resistive sensor		VDO	VDO VEGLIA DATCON CUSTOM
P09.04	Resistive sensor offset	Ohm	0	-30.0 - +30.0
P09.05	Temperature CAN bus measurement		°C	°C °F
P09.06	MAX. temperature prealarm	°	90	20-300
P09.07	MAX. temperature alarm limit	°	100	20-300
P09.08	MIN. temperature alarm limit	°	OFF	OFF/20-300
P09.09	Load increase temperature	°	OFF	OFF/20-300
P09.10	Heater activation threshold	°	OFF	OFF/20-300
P09.11	Heater deactivation threshold	°	OFF	OFF/20-300
P09.12	Temperature sensor fault alarm delay	min	OFF	OFF / 1 – 60

- P09.01** – Specifies which source is used for reading the coolant temperature. **OFF** = not managed. **RES** = Read from resistive sensor with analog input on TEMP terminal. **CAN** = Read from CANbus. **AINx** = Read from analog input of an EXP expansion module.
- P09.02** – Channel number (x) to specify if AINx was selected for the previous parameter.
- P09.03** – When using a resistive sensor, selects which curve to use. The curves can be custom set using the Customisation manager software.
- P09.04** – When using a resistive sensor, this lets you add or subtract an offset in Ohms from the set curve, to compensate for cable length for example. This value can also be set without opening setup by using the quick function in the commands menu which lets you view the measurements while calibrating.
- P09.05** – Selects the unit of measurement for the temperature.
- P09.06** – **P09.07** – Define respectively the alarm and prealarm thresholds for MAX. temperature of the liquid. See respective alarms.
- P09.08** – Defines the min. liquid temperature alarm threshold. See respective alarms.
- P09.09** – If the engine temperature is higher than this threshold (engine is warm), then the load is connected to the generator after 5s instead of waiting the usual presence delay set with P14.05. If instead the temperature is lower, then the system will wait the elapsing of the whole presence time.
- P09.10** – **P09.11** – Defines the thresholds for on-off control of the output programmed with the preheating function
- P09.12** – Delay before a temperature resistive sensor fault alarm is generated.

M10 – FUEL LEVEL		U/M	Default	Range
P10.01	Reading source		OFF	OFF RES CAN
P10.03	Type of resistive sensor		VDO	VDO VEGLIA DATCON CUSTOM
P10.04	Resistive sensor offset	Ohm	0	-30.0 - +30.0
P10.05	Capacity CAN bus measurement		%	% l gal
P10.06	Tank capacity		OFF	OFF / 1-30000
P10.07	MIN. fuel level prealarm	%	20	0-100
P10.08	MIN. fuel level	%	10	0-100
P10.09	Start filling with fuel pump level	%	OFF	OFF/ 0-100
P10.10	Stop filling with fuel pump level	%	OFF	OFF/ 0-100
P10.11	Rated hourly engine consumption	l/h	OFF	OFF / 0.0-100.0
P10.12	Fuel theft alarm sensitivity	%	OFF	OFF / 0-100
P10.13	Enable AN bu efficiency page		OFF	OFF ON

P10.01 – Specifies which source is used for reading the fuel level. **OFF** = not managed. **RES** = Read from resistive sensor with analog input on FUEL terminal.
CAN = Read from CANbus.

P10.03 – When using a resistive sensor, selects which curve to use. The curves can be custom set using the Customisation manager software.

P10.04 – When using a resistive sensor, this lets you add or subtract an offset in Ohms from the set curve, to compensate for cable length for example. This value can also be set without opening setup by using the quick function in the commands menu, which lets you view the measurements while calibrating.

P10.05 – Selects the unit of measurement for fuel tank capacity and available fuel.

P10.06 – Defines the fuel tank capacity, used to indicate autonomy.

P10.07 – **P10.08** – Defines respectively the prealarm and alarm thresholds for min. fuel level. See respective alarms.

P10.09 – The fuel filling pump starts when the fuel drops below this level.

P10.10 – The fuel filling pump stops when the fuel reaches or is higher than this level.

P10.11 – Rated hourly engine consumption. Used to calculate minimum autonomy left.

P10.12 – Sets a coefficient for fuel theft alarm sensitivity. Low values = high sensitivity - High values = low sensitivity. Suggested values between 3% and 5%.

P10.13 – Enables the display of a sub-page on the fuel level page, with the genset energy efficiency data.

M11 – ENGINE STARTING		U/M	Default	Range
P11.01	Battery charger alternator voltage engine start threshold	VDC	10.0	OFF/3.0-30
P11.02	Generator voltage engine start threshold	%	25	OFF/10-100
P11.03	Generator frequency engine start threshold	%	30	OFF/10-100
P11.04	Engine speed start threshold	%	30	OFF/10-100
P11.05	Glow plugs preheating time	s	OFF	OFF/1-600
P11.06	Fuel preheating disconnection temperature	°	OFF	OFF/20-300
P11.07	Fuel preheating timeout	s	OFF	OFF/1-900
P11.08	Time between Ev and start	s	1.0	OFF/1.0-30.0
P11.09	Number of CAN bus e starts		5	1-30
P11.10	Duration of CAN bus e starts	s	5	1-60
P11.11	Pause between CAN bus e starts	s	5	1-60
P11.12	Pause between end of attempted start and next attempt	s	OFF	OFF/1-60
P11.13	Alarms inhibition time after starting	s	8	1-120
P11.14	Overspeed inhibition time after starting	s	8	1-120
P11.15	Deceleration time	s	OFF	OFF/1-600
P11.16	Deceleration end temperature	°	OFF	OFF/20-300
P11.17	Cooling cycle mode		Load	Always Load Temp. Thresh.
P11.18	Cooling time	s	120	1-3600
P11.19	Cooling end temperature threshold	°	OFF	OFF/1-250
P11.20	Stop magnets time	s	OFF	OFF/1-60
P11.21	Gas valve delay	s	OFF	OFF/1-60
P11.22	Priming valve time	s	OFF	OFF/1-60
P11.23	Choke time	s	OFF	OFF/1-60
P11.24	Air disconnect threshold	%	5	1-100
P11.25	No. of attempted starts with air		2	1-10
P11.26	Air attempts mode		Consecutive	Consecutive Alternating
P11.27	Compressed air starting attempts mode		OFF	OFF Consecutive Alternating
P11.28	Fuel solenoid valve mode		Normal	Normal Continuous
P11.29	Glow plugs mode		Normal	Normal +Start +Cycle
P11.30	Stop magnets mode		Normal	Normal Pulse No pause
P11.31	Deceleration mode before stopping		Enabled	Enabled Disabled

P11.01 – Battery charger alternator voltage engine running acknowledgement threshold (D+/AC).

P11.02 – Generator voltage engine running acknowledgement threshold (VAC).

P11.03 – Generator frequency engine running acknowledgement threshold.

P11.04 – Engine running 'W' or pick-up speed signal acknowledgement threshold.

P11.05 – Glow plug preheating time before starting.

P11.06 – Engine temperature above which fuel preheating is disabled.

P11.07 – Max. fuel preheating time.

P11.08 – Time between the activation of fuel EV and the activation of starting motor.

P11.09 – Total number of automatic engine start attempts.

P11.10 – Duration of start attempt.

P11.11 – Pause between one start attempt, during which no engine running signal was detected, and next attempt.

P11.12 – Pause between one start attempt which was stopped due to a false start and next start attempt.

P11.13 – Alarms inhibition time immediately after engine start. Used for alarms with the "engine running" property activated. Example: min. oil pressure

P11.14 – As for previous parameter, with reference in particular to max. speed alarms.

P11.15 – Programmed output energizing time with decelerator function.

P11.16 – Engine temperature above which the deceleration function is disabled.

P11.17 – Cooling cycle mode. **Always** = The cooling cycle runs always every time the engine stops in automatic mode (unless there is an alarm that stops the engine immediately). **Load** = The cooling cycle only runs if the generator has connected to the load. **Temperature threshold** = The cooling cycle is only run for as long as the engine temperature is higher than the threshold specified in the following parameters.

P11.18 – Max. duration of the cooling cycle. Example: time between load disconnection from the generator and when the engine actually stops.

P11.19 – Temperature below which cooling is stopped.

P11.20 – Programmed output energizing time with stop magnets function.

P11.21 – Time from the activation of the start output (starter motor) and the activation of the output programmed with the function gas valve.

P11.22 – Programmed output energizing time with priming valve function.

P11.23 – Programmed output energizing time with choke function.

P11.24 – Percentage threshold with reference to set rated generator voltage, after which the output programmed as choke is de-energized.

P11.25 – Number of attempts with choke on.

P11.26 – Choke command mode for petrol engines. **Consecutive** = All starts use the choke. **Alternate** = Alternate starts with and without choke.

P11.27 – Compressed air start output command mode: **OFF** = The output programmed with the compressed air start function is disabled. **Consecutive** = The first half of the starts are with the starting output, the second half with the output programmed for compressed air. **Alternate** = The starts alternate between activation of the starting output and the output programmed for compressed air.

P11.28 – Fuel solenoid valve output command mode: **Normal** = The fuel solenoid valve relay is disabled between start attempts. **Continuous** = The fuel solenoid valve remains enabled between start attempts.

P11.29 – Glowplug preheating output command mode: **Normal** = The glowplugs output is energized for the set time before starting. **+Start** = The glowplugs output remains energized also during the starting phase. **+Cycle** = The glowplugs output remains energized also during the starting cycle.

P11.30 – Stop magnets output command mode: **Normal** = The stop magnets output is energized during the stop phase and continues for the set time after the engine has stopped. **Pulse** = The stop magnets output remains energized for a timed pulse only. **No pause** = The stop magnets output is not energized between one start and the next. Output The stop magnets output remains energized during the stop phase for the set time.

P11.31 – Deceleration mode before stopping: **Enabled** = During the last seconds of the cooling phase, before the engine is stopped, the deceleration output is activated (and/or deceleration command sent via CAN). **Disabled** = The deceleration output is not activated.

M12 – LOAD CHANGEOVER		U/M	Default	Range
P12.01	Mains/generator interlock time	s	0.5	0.0-60.0
P12.02	Feedback alarm delay	s	5	1-60
P12.03	Switchgear type		Contactors	Contactors Breakers Changeover
P12.04	Generator contactor open for electrical fault		ON	OFF-ON
P12.05	Type of circuit breaker/changeover switches command		Pulse	Continuous Pulse
P12.06	Opening pulse duration	s	10	0-600
P12.07	Closing pulse duration	s	1	0-600
P12.08	Circuit breakers open command		OBP	OBP OAP

P12.01 – Time from the opening of the Mains switchgear, after which the Generator switchgear closing command is given and vice versa.

P12.02 – Max. time for which the system tolerates that the input of the feedback on the switchgear state fails to correspond to the state controlled by the board, in the presence of the voltage necessary to move the same. Switchgear fault alarms are generated after this time.

P12.03 – Selects the type of switchgear. **Contactors** = Command with 2 outputs. **Motorised circuit breakers** = Command with 4 outputs (open-close Mains/open-close generator). **Motorised changeovers** = Command with 3 outputs (Close Mains, Open both, close generator).
Note: When motorised breakers or changeovers are used, the use of feedback inputs is mandatory.

P12.04 – When set to ON, if any alarm with the Electrical fault property enabled is active, the generator contactor is opened.

P12.05 – There are the following opening commands for motorised circuit breakers or changeover switches: **Pulse** = Maintained for the time necessary to complete the operation and extended for the time set in the two following parameters. **Continuous** = Opening or closing command maintained continuously.

P12.06 – **P12.07** – Impulse type command extension times (min. permanence times for the command).

P12.08 – Defines the circuit breakers open command times: **OBP (Open Before Presence)** = Sends the open command to a device before there is voltage at the alternative source (for example: following a mains outage, the mains circuit breaker open command is sent immediately, before voltage is supplied by the generator). **OAP (Open After Presence)** = The opening command is only generated after voltage from the alternative source is available.

M13 – MAINS VOLTAGE CONTROL		U/M	Default	Range
P13.01	MIN. voltage limit	%	85	70-100
P13.02	MIN voltage delay	s	5	0-600
P13.03	MAX. voltage limit	%	115	100-130 / OFF
P13.04	MAX. voltage delay	s	5	0-600
P13.05	Mains restore delay within limits	s	20	1-9999
P13.06	MIN./MAX. limits hysteresis	%	3.0	0.0-5.0
P13.07	MAX. asymmetry limit	%	15	OFF / 5-25
P13.08	MAX. asymmetry delay	s	5	0-600
P13.09	MAX. frequency limit	%	110	100-120/OFF
P13.10	MAX. frequency delay	s	5	0-600
P13.11	MIN. frequency limit	%	90	OFF/80-100
P13.12	MIN. frequency delay	s	5	0-600
P13.13	MAINS control mode		INT	OFF INT EXT
P13.14	MAINS control in RESET/OFF mode		OFF	OFF ON OFF+GLOB ON+GLOB
P13.15	MAINS control in MAN mode		OFF	OFF ON OFF+GLOB ON+GLOB
P13.16	Engine start delay after mains outage	s	OFF	OFF / 1-9999
P13.17	Mains delay if genset has not started	s	2	0-999
P13.18	Repetition of delay mains out of limits with engine running and generator within limits		OFF	OFF ON

Note: Menu not present in RGK700SA version.

P13.01 – Percentage value for minimum voltage intervention threshold.

P13.02 – Minimum voltage intervention delay.

P13.03 – Percentage value for maximum voltage intervention threshold (can be disabled).

P13.04 – Maximum voltage intervention delay.

P13.05 – Delay after which the mains voltage is considered within the limits.

P13.06 – % hysteresis calculated with reference to the minimum and maximum value set, to restore the voltage to within the limits.

P13.07 – Maximum threshold for asymmetry between the phases, with reference to the rated voltage

P13.08 – Asymmetry intervention delay.

P13.09 – Max. frequency intervention threshold (can be disabled).

P13.10 – Max. frequency intervention delay.

P13.11 – Min. frequency intervention threshold (can be disabled).

P13.12 – Min. frequency intervention delay.

P13.13 – **OFF** = Mains control disabled. **INT** = Mains controlled by RGK700.

EXT = Mains controlled by external device. A programmable input can be used with the External mains control function connected to the external mains control device.

P13.14 – **OFF** = Mains voltage control in RESET mode disabled. **ON** = Mains control in RESET mode enabled. **OFF+GLOB** = Mains control in RESET disabled, but the relay programmed with the global alarm function trips or not depending on whether the mains is respectively absent or present. **OFF+GLOB** = Mains control in RESET enabled, and the relay programmed with the global alarm function trips or not depending on whether the mains is respectively absent or present.

P13.15 – See P13.14 with reference to MANUAL mode.

P13.16 – Engine start delay when mains voltage fails to meet set limits. If set to OFF, the starting cycle starts when the mains contactor opens.

P13.17 – Mains voltage delay within limits – engine has not started yet.

P13.18 – **OFF** = If the mains voltage goes out of limits with the engine running and generator voltage within limits, the changeover from mains to generator takes place. **ON** = Should mains outage reoccur again, the delays of mains-out-of-limits thresholds are repeated even when the engine is running and generator voltage is within programmed limits. E.g.: Main outage - Generator starting - Mains return - New mains outage (repetition of delays) with engine running and generator voltage within limits.

M14 – GENERATOR VOLTAGE CONTROL		U/M	Default	Range
P14.01	MIN. voltage limit	%	80	70-100
P14.02	MIN voltage delay	s	5	0-600
P14.03	MAX. voltage limit	%	115	100-130 / OFF
P14.04	MAX. voltage delay	s	5	0-600
P14.05	Generator voltage return delay within limits	s	20	1-9999
P14.06	MIN./MAX. limits hysteresis	%	3.0	0.0-5.0
P14.07	MAX. asymmetry limit	%	15	OFF / 5-25
P14.08	MAX. asymmetry delay	s	5	0-600
P14.09	MAX. frequency limit	%	110	100-120/OFF
P14.10	MAX. frequency delay	s	5	0-600
P14.11	MIN. frequency limit	%	90	OFF/80-100
P14.12	MIN. frequency delay	s	5	0-600
P14.13	Generator voltage control mode		INT	OFF INT EXT
P14.14	Generator voltage low alarm delay	s	240	1-600
P14.15	Generator voltage high alarm delay	s	10	1-600

P14.01 – Percentage value for minimum voltage intervention threshold.

P14.02 – Minimum voltage intervention delay.

P14.03 – Percentage value for maximum voltage intervention threshold (can be disabled).

P14.04 – Maximum voltage intervention delay.

P14.05 – Delay after which the generator voltage is considered within the limits.

P14.06 – % hysteresis calculated with reference to the minimum and maximum value set, to restore the voltage to within the limits.

P14.07 – Maximum threshold for asymmetry between the phases, with reference to the rated voltage

P14.08 – Asymmetry intervention delay.

P14.09 – Max. frequency intervention threshold (can be disabled).

P14.10 – Max. frequency intervention delay.

P14.11 – Min. frequency intervention threshold (can be disabled).

P14.12 – Min. frequency intervention delay.

P14.13 – **OFF** = Generator control disabled. **INT** = Generator controlled by RGK700. **EXT** = Generator controlled by external device. A programmable input can be used with the External mains control function connected to the external generator control device.

P14.14 – A28 Low generator voltage alarm delay.

P14.15 – A29 High generator voltage alarm delay.

M15 – GENERATOR PROTECTION		U/M	Default	Range
P15.01	Max. current alarm limit threshold	%	OFF	100-500/OFF
P15.02	Max. current intervention delay	s	4.0	0.0-60.0
P15.03	Short-circuit alarm limit threshold	%	OFF	100-500/OFF
P15.04	Short-circuit intervention delay	s	0.02	0.00-10.00
P15.05	Protection reset time	s	60	0-5000
P15.06	Protection class		OFF	OFF P1 P2 P3 P4
P15.07	Thermal protection reset time	s	60	0-5000

P15.01 – Percentage threshold with reference to the rated current set for activating the A31 Max. generator current alarm.

P15.02 – Previous parameter threshold intervention delay.

P15.03 – Percentage threshold with reference to the rated current set for activating the A32 Generator short-circuit alarm.

P15.04 – Previous parameter threshold intervention delay.

P15.05 – Time after which the thermal protection alarm can be reset.

P15.06 – Selects one of the possible integral thermal protection curves for the generator. The curves can be custom set using the Customisation manager software . If set, this enables displaying the page with the thermal state of the generator.

P15.07 – Min. time required for reset after thermal protection tripped.

P15.08 – Intervention threshold for Earth fault alarm. If set this enables displaying the corresponding page on the display.

P15.09 – Previous parameter threshold intervention delay.

M16 – AUTOMATIC TEST		U/M	Default	Range
P16.01	Enable automatic TEST		OFF	OFF / ON
P16.02	Time interval between TESTS	dd	7	1-60
P16.03	Enable TEST on Monday		ON	OFF / ON
P16.04	Enable TEST on Tuesday		ON	OFF / ON
P16.05	Enable TEST on Wednesday		ON	OFF / ON
P16.06	Enable TEST on Thursday		ON	OFF / ON
P16.07	Enable TEST on Friday		ON	OFF / ON
P16.08	Enable TEST on Saturday		ON	OFF / ON
P16.09	Enable TEST on Sunday		ON	OFF / ON
P16.10	TEST start time	h	12	00-23
P16.11	TEST start minutes	min	00	00-59
P16.12	TEST duration	min	10	1-600
P16.13	Automatic TEST with load switching		OFF	OFF Load Dummy load
P16.14	Automatic TEST run also with external stop enabled		OFF	OFF/ON

- P16.01** – Enable periodic test. This parameter can be changed directly on the front panel without using setup (see chapter Automatic Test) and its current state is shown on the relevant page of the display.
- P16.02** – Time interval between one periodic test and the next. If the test is not enabled the day the period expires, the interval will be extended to the next enabled day.
- P16.03...P16.09** Enables the automatic test in each single day of the week. OFF means the test will not be performed on that day. Warning!! The calendar clock must be set to the right date and time.
- P16.10 – P16.11** Sets the time (hour and minutes) when the periodic test starts. Warning!! The calendar clock must be set to the right date and time.
- P16.12** – Duration in minutes of the periodic test
- P16.13** – Load management during the periodic test: **OFF** = The load will not be switched. **Load** = Enables switching the load from the mains to the generator. **Dummy load** = The dummy load is switched in, and the system load will not be switched.
- P16.14** – Runs the periodic test even if the input programmed with the External stop function is enabled.

M17 – MAINTENANCE (MNTn, n=1...3)		U/M	Default	Range
P17.n.01	Service interval n	h	OFF	OFF/1-99999
P17.n.02	Service interval n count		Engine hours	Total hrs Engine hrs Load hrs

Note: This menu is divided into 3 sections, which refer to 3 independent service intervals MNT1...MNT3.

P17.n.01 – Defines the programmed maintenance period, in hours. If set to OFF, this service interval is disabled.

P17.n.02 – Defines how the time should be counted for the specific maintenance interval: **Total hours** = The actual time that elapsed from the date of the previous service. **Engine hours** = The operating hours of the engine. **Load hours** = The hours for which the generator supplied the load.

M18 – PROGRAMMABLE INPUTS (INPn, n=1...16)		U/M	Default	Range
P18.n.01	INPn input function		(various)	(see Input functions table)
P18.n.02	Channel index (x)		OFF	OFF / 1...99
P18.n.03	Contact type		NO	NO/NC
P18.n.04	Closing delay	s	0.0	0.0-6000.0
P18.n.05	Opening delay	s	0.0	0.0-6000.0

Note: This menu is divided into 6 sections that refer to 6 possible digital inputs INP1...INP6, which can be managed by the RGK700.

P18.n.01 – Selects the functions of the selected input (see programmable inputs functions table).

P18.n.02 – Index associated with the function programmed in the previous parameter. Example: If the input function is set to Cxx commands menu execution, and you want this input to perform command C.07 in the commands menu, P18.n.02 should be set to value 7.

P18.n.03 – Select type of contact: NO (Normally Open) or NC (Normally Closed).

P18.n.04 – Contact closing delay for selected input.

P18.n.05 – Contact opening delay for selected input.

M19 – PROGRAMMABLE OUTPUTS (OUTn, n=1...16)		U/M	Default	Range
P19.n.01	Output function OUTn		(CAN bus)	(see Output functions table)
P19.n.02	Function index (x)		OFF	OFF / 1...99
P19.n.03	Normal/reverse output		NOR	NOR / REV

Note: This menu is divided into 7 sections that refer to 7 possible digital outputs OUT1, OUT2, OUT3, OUT4, OUT8, OUT9 and OUT10, which can be managed by the RGK700.

P19.n.01 – Selects the functions of the selected output (see programmable outputs functions table).

P19.n.02 – Index associated with the function programmed in the previous parameter. Example: If the output function is set to Alarm Axx, and you want this output to be energized for alarm A31, then P19.n.02 should be set to value 31.

P19.n.03 – Sets the state of the output when the function associated with the same is inactive: **NOR** = output de-energized, **REV** = output energized.

M20 – COMMUNICATION (COMn, n=1)		U/M	Default	Range
P20.n.01	Node serial address		01	01-255
P20.n.02	Serial speed	bps	9600	1200 2400 4800 9600 19200 38400 57600 115200
P20.n.03	Data format		8 bit – n	8 bit, no parità 8 bit, dispari 8bit, pari 7 bit, dispari 7 bit, pari
P20.n.04	Stop bits		1	1-2
P20.n.05	Protocol		(various)	Modbus RTU Modbus ASCII Modbus TCP Propr. ASCII

Note: Channel COM1 identifies serial port RS-232.

The front IR communication port has fixed communication parameters, so no setup menu is required.

P20.n.01 – Serial (node) address of the communication protocol.

P20.n.02 – Communication port transmission speed.

P20.n.03 – Data format. 7 bit settings can only be used for ASCII protocol.

P20.n.04 – Stop bit number.

P20.n.05 – Select communication protocol.

M21 – CANBUS		U/M	Default	Range
P21.01	Engine ECU type		OFF	OFF GENERIC J1939 VOLVO EDC VOLVO EMS VOLVO EMS2 SCANIA S6 DEUTZ EMR2 PERKINS 2800 JOHN DEERE IVECO NEF IVECO CURSOR
P21.02	ECU operating mode		M	M M+E M+E+T M+E+T+C
P21.03	ECU power input		ON	OFF-1...600-ON
P21.04	CAN alarms redirect		OFF	OFF-ON

P21.01 – Selects the type of engine ECU. If the ECU you wish to use cannot be found in the list of possible choices, select Generic J1939. In this case, the RGK700 only analyses messages on the CAN that meet SAE J1939 standards.

P21.02 – Communication mode on CANbus. **M** = Measurements only. The RGK700 only captures the measurements (pressures, temperatures, etc.) sent to the CAN by the engine ECU. **M+E** – As well as the measurements, the RGK700 captures and displays the diagnostic and alarm messages of the ECU.

M+E+T – As above, but the RGK700 also sends the commands for resetting diagnostics, etc. to the CANbus. **M+E+T+C** = As above, but engine start/stop commands are also managed via CANbus.

P21.03 – ECU power extension time through the output programmed with the function ECU Power, after the solenoid valve has been de-energised. This is also the time for which the ECU is powered after the keys have been pressed on the front keyboard, to read the measurements sent by the same.

P21.04 – Some of the main alarms are generated by a CAN message, instead of in the traditional way. **OFF** = The alarms (oil, temperature, etc.) are managed in the standard way. The ECU diagnostic reports are displayed on the page CAN Diagnostics. Usually all the CAN alarms also generate the cumulative Yellow lamp (prealarm) or Red lamp (critical alarm), which can be managed with their properties. **ON** = CAN diagnostics messages with a direct correspondence in the alarms table also generate this alarm, as well as activating the yellow and red lamp. See the alarms chapter for the list of redirectable alarms.

M22 - LOAD MANAGEMENT		U/M	Default	Range
P22.01	Start-up on power threshold kW		OFF	OFF-ON
P22.02	Generator start-up threshold	kW	0	0-9999
P22.03	Start-up threshold delay	s	0	0-9999
P22.04	Stop threshold	kW	0	0-9999
P22.05	Stop threshold delay	s	0	0-9999
P22.06	Dummy load management (dummy load)		OFF	OFF 1 STEP 2 STEP 3 STEP 4 STEP
P22.07	Dummy load step switch-in threshold	kW	0	0-9999
P22.08	Dummy load switch-in delay	s	0	0-9999
P22.09	Dummy load step switch-out threshold	kW	0	0-9999
P22.10	Dummy load switch-out delay	s	0	0-9999
P22.11	Dummy load ON time	min	OFF	OFF/1-600
P22.12	Dummy load OFF time	min	OFF	OFF/1-600
P22.13	Non-priority loads switch in/out management (load shedding)		OFF	OFF 1 STEP 2 STEP 3 STEP 4 STEP
P22.14	Load shedding step switch-in threshold	kW	0	0-9999
P22.15	Load shedding switch-in delay	s	0	0-9999
P22.16	Load shedding step switch-out threshold	kW	0	0-9999
P22.17	Load shedding switch-out delay	s	0	0-9999
P22.18	Max. kW alarm threshold	%	OFF	OFF/1-250
P22.19	Max. kW alarm delay	s	0	0-9999

P22.01...P22.05 – Used to start the generator when the load exceeds a threshold in kW measured on a branch of the mains, normally to prevent exceeding the maximum limit set by the energy provider supplying the load with the generator. When the load drops to below P22.04, the generator is stopped and the load is switched back to the mains.

P22.06 – Enable dummy load management, setting the number of steps for the same. When the generator load is too low, dummy loads are switched in for the maximum number of steps set on the basis of incremental logic.

P22.07...P22.10 – Thresholds and delays for switching-in or switching-out a dummy load step.

P22.11...P22.12 – If enabled, the dummy load will be switched in and out cyclically at the time intervals defined by these parameters.

P22.13 – Enable non-priority load switch in and out (load shedding) defining the number of load sections to disconnect. When the load on the generator is low enough, non-priority loads are switched in. Otherwise when it is too high, non-priority loads are disconnected in various sections, on the basis of incremental logic.

P22.14...P22.17 – Thresholds and delays for switching-out or switching-in a non-priority load section.

P22.18...P22.19 – Thresholds and delays for generating the alarm A35 Generator kW threshold exceeded.

M23 - MISCELLANEOUS		U/M	Default	Range
P23.01	Rent hours pre-charge	h	OFF	OFF/1-99999
P23.02	Rent hours calculation method		Engine hours	Total hrs Engine hrs Loads hrs
P23.03	Enable emergency input		ON	OFF/ON
P23.04	Mutual stand-by function		OFF	OFF COM1 COM2 COM3
P23.05	Mutual stand-by alternating mode		Start	Start Time
P23.06	Mutual stand-by alternating time	h	12	1-1000
P23.07	Remote alarms mode		OFF	OFF OUT CAN
P23.08	EJP function mode		Normal	Normal EJP EJP-T SCR
P23.09	EJP starting delay	min	25	0-240
P23.10	EJP switching delay	min	5	0-240
P23.11	ELP re-switching block		ON	OFF/ON
P23.12	Start on mains feedback alarm		OFF	OFF/ON
P23.13	Operating mode output		OFF	OFF O M O+M ...
P23.14	Harmonic analysis			OFF THD HAR

P23.01 – Number of rent hours to pre-charge in the counter on command C14 Recharge rent hours.

P23.02 – Rent hours counter down count mode. When this counter reaches zero, the A48 Rent hours expired alarm is generated. **Total hours** = Decreasing count on the basis of the real time expired. **Engine hours** = The operating hours of the engine. **Load hours** = Hours supplying load.

P23.03 – Enable emergency input incorporated in terminal +COM1, common positive of outputs OUT1 and OUT2 (default function: Start and fuel solenoid valve). **ON** = When +COM1 is disconnected from the positive terminal of the battery, the A23 Emergency stop alarm is automatically generated. **OFF** = When +COM1 is disconnected from battery terminal, no alarm is generated.

P23.04 – Enables Mutual stand-by function and defines the communication port used to connect to an alternative generator.

P23.05 – Alternating genset mode for mutual stand-by function. **Start** = The gensets alternate with every request for intervention. If necessary the genset with the lowest number of operating hours is started, and remains operational as long as required (until the conditions that started the genset are no longer applicable). **Time** = If necessary the genset with the lowest number of operating hours is started, and remains operational until its operating hours exceed those of the alternative genset by an amount equal to or greater than those programmed with the following parameter. When this condition arises, the load is switched from one genset to the other.

P23.06 – Max. deviation on the operating hours of the gensets in mutual stand-by. See previous parameter.

P23.07 – Type of connection between RGK700 and RGKRR relay remote unit. **OFF** = Communication disabled. **OUT** = Communication through programmable output set for Remote alarms function, connected to the digital input of the RGKRR. **CAN** = The RGK700 and RGKRR communicate through the CAN interface. Unless there are indications to the contrary for a specific ECU, it is usually possible to communicate simultaneously with the RGKRR and the engine ECU on the same CAN line. See RGKRR manual for more details.

P23.08 – **Normal** = Standard operation in AUT mode. **EJP** = 2 programmable inputs are used, set with the functions Remote starting and Remote switching for EJP. When the starting input closes the engine start (P23.09) delay is enabled, after which the start cycle runs. Then, when the remote switching go-ahead is received, if the engine started properly, the load will be switched from the mains to the generator. The load is restored to the mains by the remote switching go-ahead opening and the genset runs a stop cycle when the start input opens. The EJP function is only enabled if the system is in automatic mode. The cutouts and alarms function as usual. **EJP-T** = The EJP/T function is a simplified variation of the previous EJP, and in this case the engine start is controlled in the same way, but a timer switches the load instead of an external signal. This function therefore uses only one digital input, the starting input. The switching delay starts from when the start command closes, and can be set using parameter P23.10 Switching delay. **SCR** = The SCR function is very similar to the EJP function. In this mode, the starting input enables genset starting as for EJP, without waiting for delay P23.09. The remote switching input still has a switching go-ahead function after Switching delay P23.10.

P23.09 – Delay between the closing of the generator EJP starting signal and the beginning of the starting cycle.

P23.10 – Delay for switching the load from mains to generator in EJP and SCR mode.

P23.11 – If ON, in EJP and EJP-T mode, the load will not be switched back to the mains in the case of a generator malfunction, but only when the signals on the EJP inputs give a go-ahead.

P23.12 – If On, in the case of a mains switchgear malfunction which does not prevent closing and the consequent generation of the alarm A41 Mains contactor anomaly, the engine is started and the load switched to the generator.

P23.13 – Defines in which operating mode the programmed output with the Operating mode function is enabled. For example, if this parameter is programmed for O+M, the Operating mode output will be enabled when the RGK700 is in OFF or MAN mode.

P23.14 – Defines whether the harmonic analysis should be performed on the generator voltage and current waveforms. **OFF** = Harmonic analysis not performed. **THD** = THD (Total Harmonic Distortion) display and calculation only. **THD+HAR** = THD display and calculation of the harmonic spectrum and wave form.

M24 - LIMIT THRESHOLDS (LIMn, n = 1...16)		U/M	Default	Range
P24.n.01	Reference measurement		OFF	OFF- (measure. List) AINx CNTx
P24.n.02	Reference measurement source		OFF	OFF MAINS GEN
P24.n.03	Channel no. (x)		1	1..99
P24.n.04	Function		Max	Max Min Min+Max
P24.n.05	Upper threshold		0	-9999 - +9999
P24.n.06	Multiplier		x1	/100 – x10k
P24.n.07	Delay	s	0	0.0 – 600.0
P24.n.08	Lower threshold		0	-9999 - +9999
P24.n.09	Multiplier		x1	/100 – x10k
P24.n.10	Delay	s	0	0.0 – 600.0
P24.n.11	Idle state		OFF	OFF-ON
P24.n.12	Memory		OFF	OFF-ON

Note: This menu is divided into 8 sections for the limit thresholds LIM1..8

P24.n.01 – Defines to which RGK700 measurements the limit threshold applies.

P24.n.02 – If the reference measurement is an electrical measurement, this defines if it refers to the generator.

P24.n.03 – If the reference measurement is an internal multichannel measurement, the channel is defined.

P24.n.04 – Defines the operating mode of the limit threshold. Max = LIMn enabled when the measurement exceeds P24.n.03. P24.n.06 is the reset threshold. Min = LIMn enabled when the measurement is less than P24.n.06. P24.n.03 is the reset threshold. Min+Max = LIMn enabled when the measurement is greater than P24.n.03 or less than P24.n.06.

P24.n.05 and P24.n.06 – Define the upper threshold, obtained by multiplying value P24.n.03 by P24.n.04.

P24.n.07 – Upper threshold intervention delay.

P24.n.08, P08.n.09, P08.n.10 – As above, with reference to the lower threshold.

P24.n.11 – Inverts the state of limit LIMn.

P24.n.12 – Defines whether the threshold remains stored and is reset manually through commands menu (ON) or if it is reset automatically (OFF).

M25 - COUNTERS (CNTn, n = 1...4)		U/M	Default	Range
P25.n.01	Count source		OFF	OFF ON INPx OUTx LIMx REMX PLCx RALx
P25.n.02	Channel number (x)		1	1-99
P25.n.03	Multiplier		1	1-1000
P25.n.04	Divisor		1	1-1000
P25.n.05	Description of the counter		CNTn	(Text – 16 characters)
P25.n.06	CAN bus measurement		Umn	(Text – 6 characters)
P25.n.07	Reset source		OFF	OFF-ON- INPx-OUTx-LIMx- REMX-PLCx-RALx
P25.n.08	Channel number (x)		1	1-16

Note: This menu is divided into 8 sections for counters CNT1..4

P25.n.01 – Signal that increments the count (on the output side). This may be the start-up of the RGK700 (ON), when a threshold is exceeded (LIMx), an external input is enabled (INPx), or for a logic condition (PLCx), etc.

P25.n.02 – Channel number x with reference to the previous parameter.

P25.n.03 – Multiplier K. The counted pulses are multiplied by this value before being displayed.

P25.n.04 – Divisional K. The counted pulses are divided by this value before being displayed. If other than 1, the counter is displayed with 2 decimal points.

P25.n.05 – Counter description. 16-character free text.

P25.n.06 – Counter unit of measurement. 6-character free text.

P25.n.07 – Signal that resets the count. As long as this signal is enabled, the count remains zero.

P25.n.08 – Channel number x with reference to the previous parameter.

M26 - USER PAGES (PAGn, n = 1...4)		U/M	Default	Range
P26.n.01	Enable page		OFF	OFF – ON
P26.n.02	Title		PAGn	(text – 16 chr)
P26.n.03	Measurement 1		OFF	OFF/ (all measures)
P26.n.04	Measurement 2		OFF	OFF/ (all measures)
P26.n.05	Measurement 3		OFF	OFF/ (all measures)

Note: This menu is divided into 4 sections for the user pages PAG1...PAG4

P26.n.01 – Enables user page PAGn.

P26.n.02 – User page title. Free text.

P26.n.03, P26.n.04, P26.n.05 – Measurements which will be displayed in the text boxes on the user page.

M27 - REMOTE ALARM/STATUS (RALn, n = 1...24)		U/M	Default	Range
P27.n.01	Output function RALn		(various)	(See Output functions table)
P27.n.02	Function index (x)		OFF	OFF / 1...99
P27.n.03	Normal/reverse output		NOR	NOR / REV

Note: This menu is divided into 24 sections for the state/alarms remote variables RAL1...RAL24, available with the RGKRR external unit.

P27.n.01 – Selects the remote output function RALn. The remote outputs (relay from RGKRR remote unit) can have the same functions as local outputs, including operating states, alarms, etc.

P27.n.02 – Index associated with the function programmed in the previous parameter. Example: If the remote output function is set to Alarm Axx, and you want this output to be energized for alarm A31, then P27.n.02 should be set to value 31.

P27.n.03 – Sets the state of the output when the function associated with the same is inactive: **NOR** = output de-energised, **REV** = output energised.

M31 - ENERGY PULSES (PULn,n=1...6)		U/M	Default	Range
P31.n.01	Pulse source		OFF	OFF kWh M kWh G kvarh M kvarh G kVA M kVA G
P31.n.02	Counting unit		100	10/100/1k/10k
P31.n.03	Pulse duration	s	0.1	0.1-1.00

Note: This menu is divided into 6 sections, for the generation of energy consumption pulse variables PUL1...PUL6.

P31.n.01 – Defines which energy meter should generate the pulse of the 6 possible meters managed by the RGK700. **kWh M** = Mains active energy. **kWh G** = Generator active energy. **kvarh M** = Mains reactive energy. **kvarh G** = Generator reactive energy. **kVA M** = Mains apparent energy. **kVA G** = Generator apparent energy.

P31.n.02 – The quantity of energy which must accumulate for a pulse to be emitted (for example 10Wh, 100Wh, 1kWh, etc.).

P31.n.03 – Pulse duration.

Application example: For every 0,1 kWh output by generator, a pulse of 100ms has to be generated on output OUT10.

First of all we should generate an internal pulse variable, for instance PUL1. So we must program section 1 of this menu as follows:

P31.1.01 = kWh G (generator active energy)

P31.1.02 = 100Wh (correspond to 0,1 kWh)

P31.1.03 = 0,5

Now we must set output OUT10 and link it to PUL1:

P19.10.01 = PULx

P19.10.02 = 1 (PUL1)

P19.10.03 = NOR

M32 - USER ALARMS (UAn, n=1...8)		U/M	Default	Range
P32.n.01	Alarm source		OFF	OFF INPx OUTx LIMx REMX PLCx RALx
P32.n.02	Channel number (x)		1	1-8
P32.n.03	Text		UAn	(text – 20 char)

Note: This menu is divided into 8 sections for user alarms UA1...UA8

P32.n.01 – Defines the digital input or internal variable that generates the user alarm when it is activated.

P32.n.02 – Channel number x with reference to the previous parameter.

P32.n.03 – Free text that appears in the alarm window.

Example of application: User alarm UA3 must be generated by the closing of input INP5, and must display the message 'Panels open'.

In this case, set the section of menu 3 (for alarm UA3):

P32.3.01 = INPx

P32.3.02 = 5

P32.3.03 = 'Panels open'

ALARMS

- When an alarm is generated, the display will show an alarm icon, the code and the description of the alarm in the language selected.

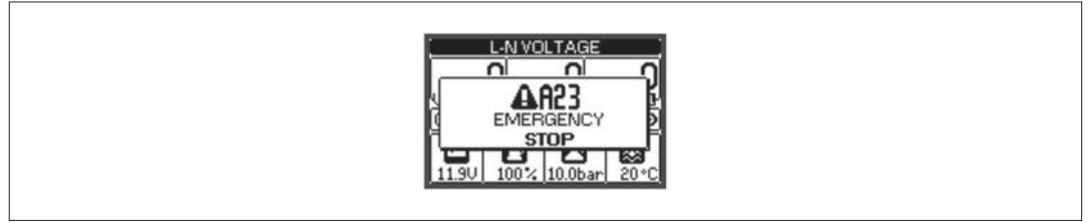

- If the navigation keys in the pages are pressed, the pop-up window showing the alarm indications will disappear momentarily, to reappear again after a few seconds.
- The red LED near the alarm icon on the front panel will flash when an alarm is active.
- If enabled, the local and remote alarm buzzers will be activated.
- Alarms can be reset in one of the following ways:
 - by pressing the key ✓
 - by pressing the OFF key.
- Switching OFF prevents unexpected engine starting after resetting the alarm.
- If the alarm cannot be reset, the problem that generated the alarm must still be solved.
- In the case of one or more alarms, the behaviour of the RGK700 depends on the properties settings of the active alarms.

ALARM PROPERTIES

Various properties can be assigned to each alarm, including user alarms (User Alarms, Uax):

- **Alarm enabled** – General enabling of the alarm. If the alarm is not enabled, it is as if it does not exist.
- **Retained alarm** – Remains stored even if the cause of the alarm has been eliminated.
- **Global alarm** – Activates the output assigned to this function.
- **Mechanical fault** – Activates the output assigned to this function.
- **Electrical fault** – Activates the output assigned to this function.
- **Siren** – Activates the output assigned to this function, as configured in the acoustic Alarms menu.
- **Engine stop** – Stops the engine.
- **Engine cooling** – Stops the engine after a cooling cycle, depending on the cooling mode programming (duration and conditions).
- **Active with engine running** – The alarm is only generated when the engine is running and the alarms activation time has elapsed.
- **Inhibition** – The alarm can be temporarily disabled by activating an input that can be programmed with the Inhibit alarms function.
- **Modem** – A modem is connected as configured in setup.
- **No LCD** – The alarm is managed normally, but not shown on the display.

ALARM TABLE

CODE	DESCRIPTION	DEFAULT ALARM PROPERTIES											
		Enabled	Retained	Glob. Al.	Fault	Fault	Siren	Engine	Cooling	Motor	Inhibit.	Modem	No LCD
A01	Engine temperature warning (analog sensor)			●			●			●		●	
A02	High engine temperature (analog sensor)		●	●	●		●	●		●		●	
A03	Analog temperature sensor fault		●	●	●		●			●		●	
A04	High engine temperature (digital sensor)	●	●	●	●		●	●		●		●	
A05	Low engine temperature (analog sensor)			●			●					●	
A06	Oil pressure prealarm (analog sensor)			●			●			●		●	
A07	Low oil pressure (analog sensor)		●	●	●		●	●		●		●	
A08	Analog pressure sensor fault		●	●	●		●					●	
A09	Low oil pressure (digital sensor)	●	●	●	●		●	●		●		●	
A10	Digital pressure sensor fault	●	●	●	●		●					●	
A11	Fuel level prealarm (analog sensor)			●			●					●	
A12	Fuel level low (analog sensor)			●			●					●	
A13	Analog level sensor fault		●	●	●		●					●	
A14	Fuel level low (digital sensor)	●		●			●					●	
A15	High battery voltage	●	●	●	●		●					●	
A16	Low battery voltage	●	●	●	●		●					●	
A17	Inefficient battery	●	●	●	●		●					●	
A18	Battery alternator fault	●	●	●	●		●	●		●		●	
A19	"Pick-up/W" signal fault		●	●	●		●			●		●	
A20	"Pick-up/W" engine speed low		●	●	●		●			●		●	
A21	"Pick-up/W" engine speed high		●	●	●		●	●		●		●	
A22	Starting failed	●	●	●	●		●	●				●	
A23	Emergency stopping	●	●	●		●	●	●				●	
A24	Unexpected stop	●	●	●	●		●	●				●	
A25	Engine stopping failure	●	●	●	●		●	●				●	
A26	Low generator frequency	●	●	●	●	●	●	●	●			●	
A27	High generator frequency	●	●	●	●	●	●	●				●	
A28	Low generator voltage	●	●	●	●	●	●	●	●			●	
A29	High generator voltage	●	●	●	●	●	●	●	●			●	
A30	Generator voltages asymmetry		●	●		●	●	●	●			●	
A31	Max. generator current	●	●	●		●	●	●	●			●	
A32	Generator short-circuit	●	●	●		●	●	●	●			●	
A33	Generator overload	●	●	●		●	●	●	●			●	
A34	Generator external protection intervention	●	●	●		●	●	●	●			●	
A35	Generator kW threshold exceeded	●	●	●		●	●	●	●			●	
A37	Generator phase sequence error		●	●		●	●	●	●				
A38	Mains phase sequence error	●				●							
A39	System frequency settings error	●				●							
A40	Generator contactor anomaly	●	●	●		●	●					●	
A41	Mains contactor anomaly	●	●	●		●	●					●	
A42	Maintenance request 1	●	●	●			●					●	
A43	Maintenance request 2	●	●	●			●					●	
A44	Maintenance request 3	●	●	●			●					●	
A45	System Error	●											
A46	Tank too empty			●	●		●	●					
A47	Tank too full			●			●						
A48	Rent hours expired			●			●	●	●				
A49	Radiator coolant level low	●	●	●	●		●	●	●			●	
A50	Manual circuit breaker closed		●	●		●	●	●					
A51	Manual circuit breaker open		●	●		●	●	●					
A52	Battery charger alarm			●		●	●						
A53	CANbus red lamp alarm	●	●	●	●		●	●				●	
A54	CANbus yellow lamp alarm	●		●	●								
A55	CANbus error	●	●	●	●		●					●	
A56	Fuel theft	●	●	●			●					●	
A57	Cannot change configuration	●	●	●		●						●	
A58	Water in fuel	●	●	●	●		●	●				●	
A59	Fuel filling pump failure	●	●	●	●		●	●				●	
A60	Mutual standby link error	●											
UA1	UA1												
UA2	UA2												
UA3	UA3												
UA4	UA4												
UA5	UA5												
UA6	UA6												
UA7	UA7												
UA8	UA8												

ALARM DESCRIPTION

CODE	DESCRIPTION	ALARM EXPLANATION
A01	Engine temperature prealarm (analog sensor)	Engine temperature higher than prealarm threshold set in P09.06.
A02	High engine temperature (analog sensor)	Engine temperature higher than alarm threshold set in P09.07.
A03	Analog temperature sensor fault	Open circuit (disconnected) resistive temperature sensor. If the measurement has been sent by the CAN, the alarm is generated by a specific diagnostics message.
A04	High engine temperature (digital sensor)	Engine overtemperature signal on activation of digital input programmed with relevant function.
A05	Low engine temperature (analog sensor)	Engine temperature lower than alarm threshold set in P09.08.
A06	Oil pressure prealarm (analog sensor)	Engine oil pressure lower than prealarm threshold set in P08.06.
A07	Low oil pressure (analog sensor)	Engine oil pressure lower than alarm threshold set in P08.07.
A08	Analog pressure sensor fault	Open circuit (disconnected) resistive pressure sensor. If the measurement has been sent by the CAN, the alarm is generated by a specific diagnostics message.
A09	Low oil pressure (digital sensor)	Low oil pressure signal on activation of digital input programmed with relevant function.
A10	Digital pressure sensor fault	Engine stopped for over one minute, but oil sensor failed to close on no pressure signal. Presumed break in connection.
A11	Fuel level prealarm (analog sensor)	Fuel level lower than prealarm threshold set in P10.07.
A12	Fuel level low (analog sensor)	Fuel level lower than alarm threshold set in P10.08.
A13	Analog level sensor fault	Open circuit (disconnected) resistive fuel level sensor.
A14	Fuel level low (digital sensor)	Low fuel level signal on activation of digital input programmed with relevant function.
A15	High battery voltage.	Battery voltage higher than threshold set in P05.02 for time greater than P05.04.
A16	Low battery voltage	Battery voltage lower than threshold set in P05.03 for time greater than P05.04.
A17	Inefficient battery	Starting attempts expired with battery voltage below min. starting threshold.
A18	Battery alternator fault	This alarm is generated when the engine is running (voltage and/or frequency from generator or 'Pick-up/W') but the battery-charger alternator signal (D+) remains below engine running voltage threshold P11.01 for more than 4 seconds.
A19	"Pick-up/W" signal fault	With speed measurement enabled, This alarm is generated when the engine is running (battery charger alternator signal present or voltage and/or frequency from generator) but the 'Pick-up/W' speed signal has not been detected within 5 seconds. If the measurement has been sent by the CAN, the alarm is generated by a specific diagnostics message.
A20	"Pick-up/W" engine speed low	This alarm is generated when the engine is running (battery charger alternator signal present or voltage and/or frequency from generator) but the 'Pick-up/W' speed signal remains below threshold P07.05 for longer than the time set in P07.06.
A21	"Pick-up/W" engine speed high	This alarm is generated when the 'Pick-up/W' speed signal remains below threshold P07.03 for longer than the time set in P07.04.
A22	Starting failed	This alarm is generated after the set number of starting attempts if the engine has not started.
A23	Emergency stopping	This alarm is generated when terminal +COM1 is disconnected (with P23.03 enabled) or by the opening of a digital input programmed with the 'Emergency stop' function'.
A24	Unexpected stop	This alarm is generated when the engine stops on its own after the alarms activation time if it was not stopped by the system.
A25	No stop	Alarm generated if the engine still has not stopped 65 seconds after the stop phase began.
A26	Low generator frequency	This alarm is generated when the engine is running but the generator frequency is lower than P14.11 for the time set in P14.12.
A27	High generator frequency	This alarm is generated when the generator frequency is higher than P14.09 for the time set in P14.10.
A28	Low generator voltage	This alarm is generated when the engine is running but the generator voltage is lower than P14.01 for the time set in P14.14
A29	High generator voltage	This alarm is generated when the generator voltage is higher than P14.13 for the time set in P14.15.
A30	Generator voltages asymmetry	Alarm generated when the imbalance between the generator voltages exceeds P14.07 for the time set in P14.08.
A31	Max. generator current	The generator current exceeds the percentage threshold set in P15.01 for the delay set in P15.02. When this alarm is generated, you must wait for the time set in P15.05 before resetting it.
A32	Generator short-circuit	The generator current exceeds the percentage threshold set in P15.03 for the delay set in P15.04.
A33	Generator overload	Electronic cutout tripped because of percentage current and protection curve selected. When this alarm is generated, you must wait for the time set in P15.07 before resetting it.
A34	Generator external protection intervention	If programmed, this alarm is generated when the contact of the digital input of the generator thermal cutout closes, if the genset is running.
A35	Generator kW threshold exceeded	The generator active power exceeds the percentage threshold set in P22.18 for the delay set in P22.19.
A37	Generator phase sequence error	The generator phase sequence does not correspond to the programmed sequence.
A38	Mains phase sequence error	The mains phase sequence does not correspond to the programmed sequence.
A39	System frequency settings error	Alarm generated when the system frequency does not correspond to the set rated frequency.
A40	Generator contactor anomaly	Alarm generated if a discrepancy is detected after the set time between the state of the command output and the generator contactor/circuit breaker feedback input.
A41	Mains contactor anomaly	Alarm generated if a discrepancy is detected after the set time between the state of the command output and the mains contactor/circuit breaker feedback input.

ALARM DESCRIPTION

COD	DESCRIPTION	ALARM EXPLANATION
A42	Maintenance request 1	Alarm generated when the maintenance hours of the relevant interval reach zero. See menu M17. Use the commands menu to reset the operating hours and the alarm.
A43	Maintenance request 2	
A44	Maintenance request 3	
A45	System error	RGK700 internal error. See System errors chapter for possible solutions.
A46	Tank too empty	The relevant programmable input signals tank too empty (active open default). Filling pump stopped.
A47	Tank too full	The relevant programmable input signals 'tank too full' (active closed default). Filling pump stopped.
A48	Rent hours expired	Alarm generated when the rent hours reach zero. Use the commands menu to reset the rent hours and the alarm.
A49	Radiator coolant level low	Alarm generated when the coolant level is lower than the min. level. Generated by digital input or CAN diagnostics message.
A50	Manual circuit breaker closed	Alarm generated in MAN mode during the starting phase, when the disabled state of the input programmed with the function Circuit breaker state alarm is detected.
A51	Manual circuit breaker open	Alarm generated in AUT mode during the starting phase, with the engine running, when the enabled state of the input programmed with the function Circuit breaker state alarm is detected.
A52	Battery charger alarm	Alarm generated by the input programmed with the function Battery charger alarm connected to an external battery charger when the mains voltage is within the limits.
A53	CAN bus red lamp alarm	Global alarm generated on the CAN bus by the engine ECU for critical anomalies.
A54	CAN bus yellow lamp alarm	Global alarm generated on the CAN bus by the engine ECU for prealarms or minor anomalies.
A55	CAN bus error	CAN bus communication error. Check wiring diagrams and connecting cables.
A56	Fuel theft	The tank level has dropped at too high an average rate compared to the max. nominal engine fuel consumption. Suspected theft of fuel.
A57	Cannot change configuration	The position of the digital inputs for selecting the 4 possible configurations has changed, but there are no conditions that warrant said change (for example: engine running or operating mode other than OFF).
A58	Water in fuel	Alarm generated when the contact signals 'water in fuel'. Generated by digital input or CAN diagnostics message.
A59	Fuel filling pump failure	Alarm generated when the fuel level in the tank does not increase of at least 1% in a time of 5min. Available from SW rev. 01 onward.
A60	Mutual standby link error	Alarm generated when the communication link between the two devices in mutual-standby is not operating properly. Available from SW rev. 03 onward.
UA1 ... UA8	User alarm	The user alarm is generated by enabling the variable or associated input in menu M32.

INPUT FUNCTION TABLE

- The following table shows all the functions that can be attributed to the INPn programmable digital inputs.
- Each input can be set for an reverse function (NO – NC), delayed energising or de-energising at independently set times.
- Some functions require another numeric parameter, defined in the index (x) specified by parameter **P18.n.02**.
- See menu M18 Programmable inputs for more details.

FUNCTION	DESCRIPTION
Disabled	Disabled input
Configurable	User configuration free To use for example if the input is used in PLC logic.
Oil pressure	Engine oil pressure low digital sensor
Engine temperature	Engine max. temperature digital sensor
Fuel level	Fuel level low digital sensor
Emergency stop	Generates alarm A23 when open. Not required if common +COM1 with built-in input is used.
Remote stop	Stops the engine remotely in AUT mode.
Off load remote start	Starts the engine remotely without switching the load to the generator in AUT mode. The signal must be maintained for the time you want the engine to run. The engine begins the stop cycle when the signal is disabled.
On load remote start	Starts the engine remotely, switching the load to the generator in AUT mode. The signal must be maintained for the time you want the engine to run. The engine begins the stop cycle when the signal is disabled.
Starting without stop	Starts the engine remotely without the stop function in the case of an alarm. The signal must be maintained for the time you want the engine to run. The engine begins the stop cycle when the signal is disabled.
Automatic test	Starts the periodic test managed by an external timer.
Generator cutout	Generator cutout intervention signal from external device.
Remote control lock	Inhibits the serial port writing and command operations. The data can still be read.
Setup access lock	Inhibits access to the programming menu.
External MAINS control	Mains voltage control signal from external device. Enabled indicates the voltage is within the limits. Not available on RGK700SA.
External GEN control	Generator voltage control signal from external device. Enabled indicates the voltage is within the limits.
Enable mains load increase	Go-ahead for connection of load to mains. Not available on RGK700SA.
Enable generator load increase	Go-ahead for connection of load to generator.
Remote switching	In AUT mode, when enabled this switches from mains to generator. Not available on RGK700SA.
Inhibit automatic return to mains.	Inhibits automatic reswitching to the mains when its values are within the limits. Not available on RGK700SA.
MAINS contactor feedback.	Auxiliary contact of mains switchgear used to inform RGK of its actual state (feedback). An alarm A41 is generated in the case of discrepancy between the command output and state. Not available on RGK700SA.
GEN contactor feedback.	As above, with reference to the generator switchgear. An alarm A40 is generated in the case of discrepancy between the command output and state.
Tank empty	Tank too empty. Generates the alarm A46 with an open contact. The filling pump is stopped. Can function independently of start-stop.
Start filling.	Tank low level sensor. The filling pump is started with an open contact.
Stop filling	Tank full The filling pump is stopped with a closed contact.
Tank too full	Tank too full. Generates the alarm A47 with a closed contact. The filling pump is stopped. Can function independently of start-stop.
Keyboard lock	Inhibits the functions of the front keyboard.
Block genset and keyboard	Block generator and keyboard.
Radiator coolant level	The alarm A49 Radiator liquid low is generated with the input enabled.
Siren OFF	Disables the siren.
Circuit breaker state alarm	In the manual mode and with input ON, starting is inhibited, generating the alarm A50 Circuit breaker closed. In manual mode this function is used when the generator contactor is not used and a thermal magnetic circuit breaker is used. This function is required to start the generator when certain the load is disconnected. In AUT mode and with input OFF, starting is inhibited, generating the alarm A51 Circuit breaker open. This function is required to prevent starting the generator and consuming fuel needlessly.
Battery charger alarm	With the input enabled, generates the alarm A52 External battery charger fault. The alarm is only generated when there is mains voltage.
Inhibit alarms	If enabled, disables the alarms with the property Inhibit alarms activated.
Alarm Reset.	Resets the retained alarms for which the condition that triggered the same has ceased.
Commands menu C(x)	Executes the command from the commands menu defined by index parameter (x).
Simulate OFF key	Closing the input is the equivalent of pressing the key.
Simulate MAN key	Closing the input is the equivalent of pressing the key.
Simulate AUTO key	Closing the input is the equivalent of pressing the key.
Simulate TEST key	Closing the input is the equivalent of pressing the key.
Simulate START key	Closing the input is the equivalent of pressing the key.
Simulate STOP key	Closing the input is the equivalent of pressing the key.
Simulate MAINS key	Closing the input is the equivalent of pressing the key.
Simulate GEN key	Closing the input is the equivalent of pressing the key.
Fuel theft	When active, it generates Fuel theft alarm, a san alternative to the fuel theft detection made by analog level.
Inhibit automatic test	Inhibits the automatic test
LED key	Turns all the LEDS on the front panel on (test lamps)
Select configuration (x)	Selects one of four possible configurations. The binary code weight is defined by index parameter (x). See chapter Multiple configurations.
Water in fuel	Generates the alarm A58 Water in fuel

OUTPUT FUNCTION TABLE

- The following table shows all the functions that can be attributed to the OUTn programmable digital inputs.
- Each output can be configured so it has a normal or reverse (NOR or REV) function.
- Some functions require another numeric parameter, defined in the index (x) specified by parameter **P19.n.02**.
- See menu M19 Programmable outputs for more details.

FUNCTION	DESCRIPTION
Disabled	Output disabled
Configurable	User configuration free to use for example if the output is used in PLC logic.
Close mains contactor/circuit breaker	Command to close mains contactor/circuit breaker Not available on RGK700SA.
Close generator contactor/circuit breaker	Command to close generator contactor/circuit breaker
Open mains circuit breaker	Command to open mains circuit breaker Not available on RGK700SA.
Open generator circuit breaker	Command to open generator circuit breaker
Open mains/generator	Open both circuit breakers/neutral position of motorized commutator
Starter motor	Powers the starter motor
Fuel solenoid valve	Energizes the fuel valve
ECU power	Powers the engine ECU
Global alarm	Output enabled in the presence of any alarm with the Global alarm propriety enabled.
Siren	Powers the siren
Decelerator	Reduce rpm in starting phase Energized as soon as the engine starts, for the max duration set.
Accelerator	Opposite function to the above.
Stop magnets	Output energized for engine stop
Glowplugs	Glowplug preheating before starting
Gas valve	Gas delivery solenoid valve. Opening delayed in relation to starter motor activation, and closed in advance in relation to stop command.
Choke	Choke for petrol engines
Priming valve	Petrol injection for starting gas-fuelled engines The priming valve relay is enabled at the same time as the gas solenoid valve only during the first start attempt.
Dummy load steps (x)	Controls the contactors to switch in the dummy load (x=1...4).
Load shedding steps (x)	Controls the contactors for load shedding (x=1...4)
Compressed air	Start engine with compressed air, as an alternative/alternating with starter motor. See parameter P11.26.
Operating mode	Output energized when the RGK700 is in one of the modes set with parameter P23.13.
Mains voltage state	Energized when the mains voltage returns within the set limits. Not available on RGK700SA.
Generator voltage state	Energized when the generator voltage returns within the set limits.
Engine running	Energized when the engine is running.
OFF mode	Energized when the RGK700 is OFF.
MAN mode	Energized when the RGK700 is in MAN mode.
AUT mode	Energized when the RGK700 is in AUT mode.
TEST mode	Energized when the RGK700 is in TEST mode.
Cooling	Energized when the cooling cycle is running
Generator ready	Indicates the RGK700 is in automatic mode and there are no active alarms.
Preheating valve	Controls the fuel preheating valve See description of parameters P11.06 and P11.07.
Heater	Controls the engine heater, using engine temperature reading and parameters P09.10 and P09.11.
Fuel filling pump	Controls the fuel filling pump Can be controlled by the start and stop inputs, or on the basis of the level detected by the analog sensor. See parameters P10.09 and P10.10.
Remote alarms/states	Pulse output for communication with the RGKRR in digital I/O mode.
LIM limits (x)	Output controlled by the state of the limit threshold LIM(x) (x=1..16) defined by the index parameter.
PUL pulses (x)	Output controlled by the state of the energy pulse variables PUL(x) (x=1..6).
Flag PLC(x)	Output controlled by flag PLCx (x=1..32).
REM(x) remote variable	Output controlled by remote variable REMx (x=1..16).
Alarms A01-Axx	Output energized with alarm Axx is enabled (xx=1...alarms number).
Alarms UA1..Uax	Output energized with alarm Uax is enabled (x=1...8).

COMMANDS MENU

- The commands menu allows executing some occasional operations like reading peaks resetting, counters clearing, alarms reset, etc.
- If the Advanced level password has been entered, then the commands menu allows executing the automatic operations useful for the device configuration.
- The following table lists the functions available in the commands menu, divided by the access level required.

CODE	COMMAND	ACCESS LEVEL	DESCRIPTION
C01	Reset maintenance interval 1	User	Resets maintenance alarm MNT1 and recharges the counter with the set number of hours.
C02	Reset maintenance interval 2	User	As above, with reference to MNT2.
C03	Reset maintenance interval 3	User	As above, with reference to MNT3.
C04	Reset engine partial hour counter	User	Resets the partial counter of the engine.
C05	Reset mains partial energy.	User	Resets the mains partial energy counter. (only for RGK700)
C06	Reset generator partial energy.	User	Resets the generator partial energy counter.
C07	Reset generic counters CNTx	User	Resets generic counters CNTx.
C08	Reset limits status LIMx	Utente	Reset ritenitive limits status LIMx.
C09	Reset High/ low	User	Resets High/low peaks of the measures
C10	Reset engine total hour counter	Advanced	Resets the total counter of the engine.
C11	Engine hour counter settings	Advanced	Lets you set the total hour counter of the engine to the desired value.
C12	Reset no. starts counter	Advanced	Resets counter for the number of attempted starts and the percentage of successful attempts.
C13	Reset closing counters	Advanced	Resets the generator on-load counter.
C14	Reset mains total counter.	Advanced	Resets the mains total energy counter. (only for RGK700)
C15	Reset generator total counter.	Advanced	Resets the generator total energy counter.
C16	Reload rent hours	Advanced	Reloads rent timer to set value.
C17	Reset events list	Advanced	Resets the list of historical events.
C18	Reset default parameters	Advanced	Resets all the parameters in the setup menu to the default values.
C19	Save parameters in backup memory	Advanced	Copies the parameters currently set to a backup for restoring in the future.
C20	Reload parameters from backup memory	Advanced	Transfers the parameters saved in the backup memory to the active settings memory.
C21	Fuel purge	Advanced	Energizes the fuel valve without starting the engine. The valve remains energized for max 5 min. or until the OFF mode is selected.
C22	Forced I/O	Advanced	Enables test mode so you can manually energize any output. Warning! In this mode the installer alone is responsible for the output commands.
C23	Resistive sensors offset regulation	Advanced	Lets you calibrate the resistive sensors, adding/subtracting a value in Ohms to/from the resistance measured by the resistive sensors, to compensate for cable length or resistance offset. The calibration displays the measured value in engineering magnitudes.
C24	Reset PLC program	Advanced	Delete the program with the PLC logic from the internal memory of the RGK700.
C25	Sleep mode	Advanced	Enables battery-saving sleep mode.

- Once the required command has been selected, press **✓** to execute it. The device will prompt for a confirmation. Pressing **✓** again, the command will be executed.
- To cancel the command execution press **OFF**.
- To quit command menu press **OFF**.

INSTALLATION

- RGK700 is designed for flush-mount installation. With proper mounting, it guarantees IP65 front protection.
- Insert the device into the panel hole, making sure that the gasket is properly positioned between the panel and the device front frame.
- Make sure the tongue of the custom label does not get trapped under the gasket and break the seal. It should be positioned inside the board.
- From inside the panel, for each four of the fixing clips, position the clip in its square hole on the housing side, then move it backwards in order to position the hook.

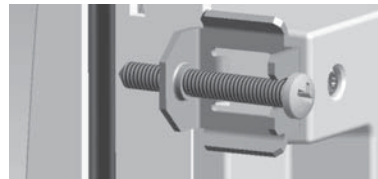

- Repeat the same operation for the four clips.
- Tighten the fixing screw with a maximum torque of 0.5Nm.
- In case it is necessary to dismount the system, repeat the steps in opposite order.
- For the electrical connection see the wiring diagrams in the dedicated chapter and the requirements reported in the technical characteristics table.

WIRING DIAGRAMS

Wiring diagram for three-phase generating set with pre-energised battery charger alternator

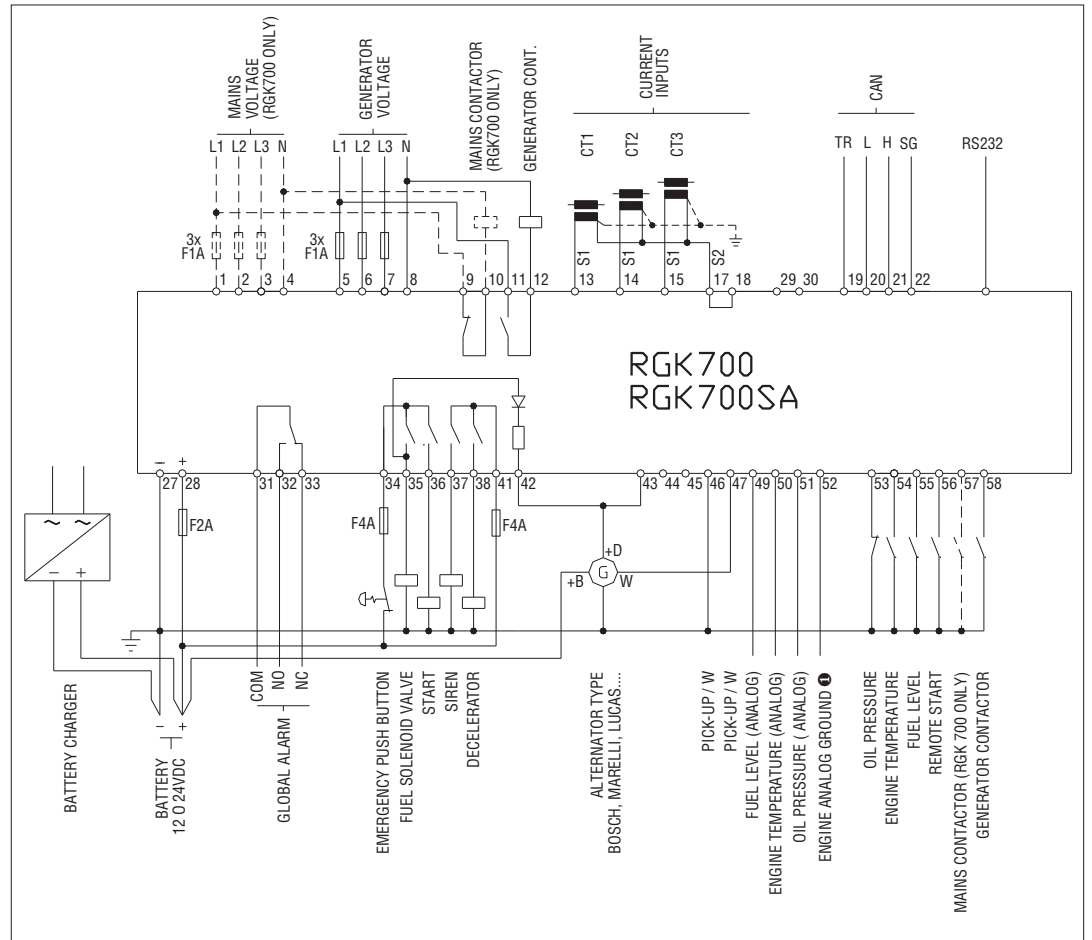

① Reference earth for analog sensors to be connected directly on the engine block.

NOTES



S2 terminals are internally interconnected.
The dotted section refers to use with RGK700 control

CANBUS CONNECTION



The CANbus connection has two 120-Ohm termination resistors at both ends of the bus.
To connect the resistor incorporated in the RGK700 board, jumper TR and CAN-L.

WIRING FOR SINGLE-PHASE GENERATING SET

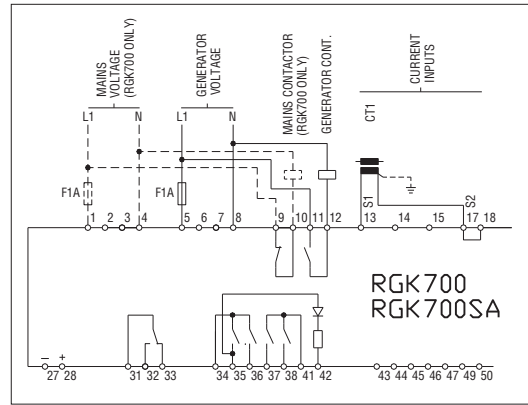

WIRING FOR TWO-PHASE GENERATING SET

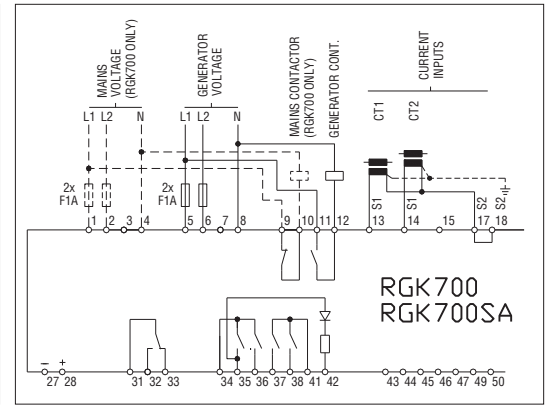

NOTES
S2 terminals are internally interconnected.
The dotted section refers to use with RGK 700 control.

WIRING FOR GENERATING SET WITH PERMANENT MAGNET BATTERY CHARGER ALTERNATOR

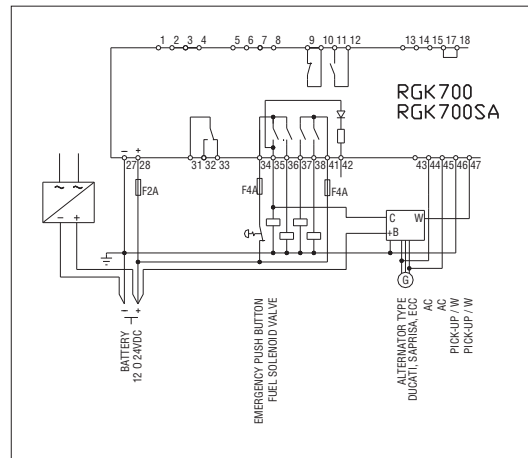

WIRING FOR GENERATING SET WITH PICK-UP SPEED DETECTOR

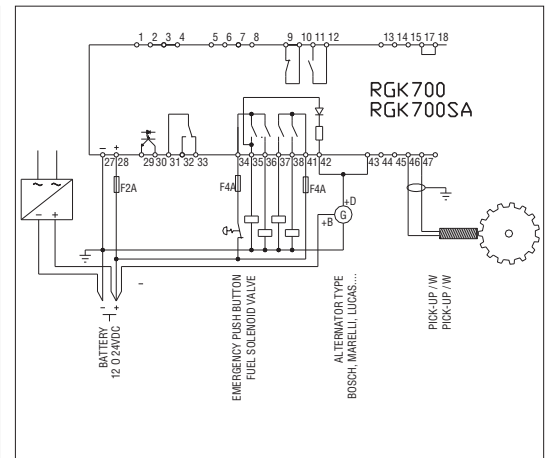

TERMINAL ARRANGEMENT

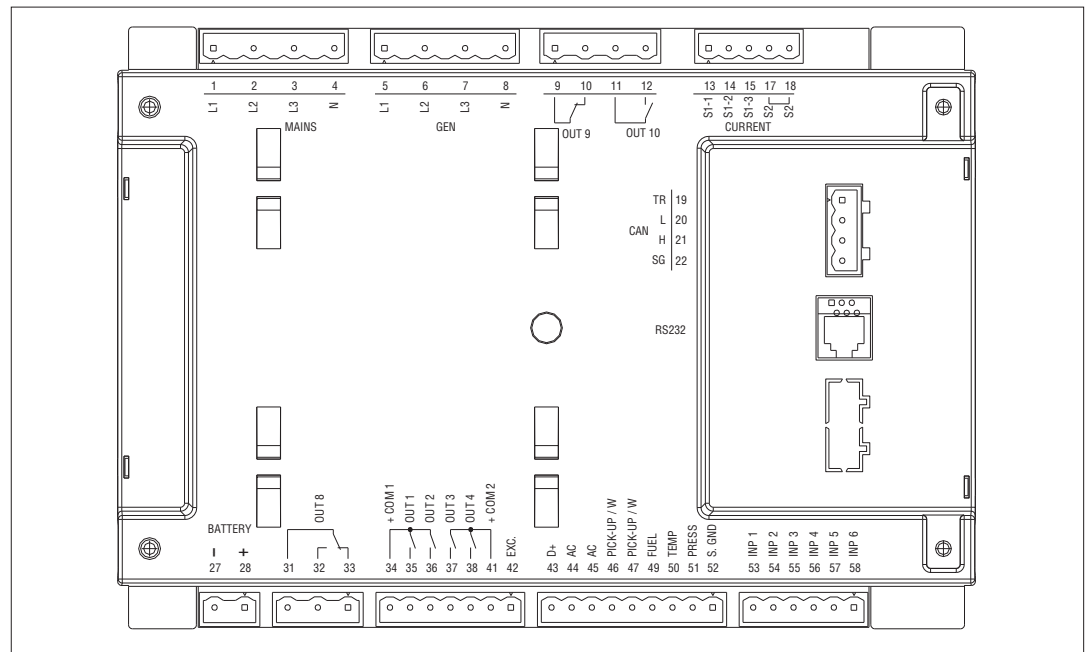

MECHANICAL DIMENSIONS (mm)

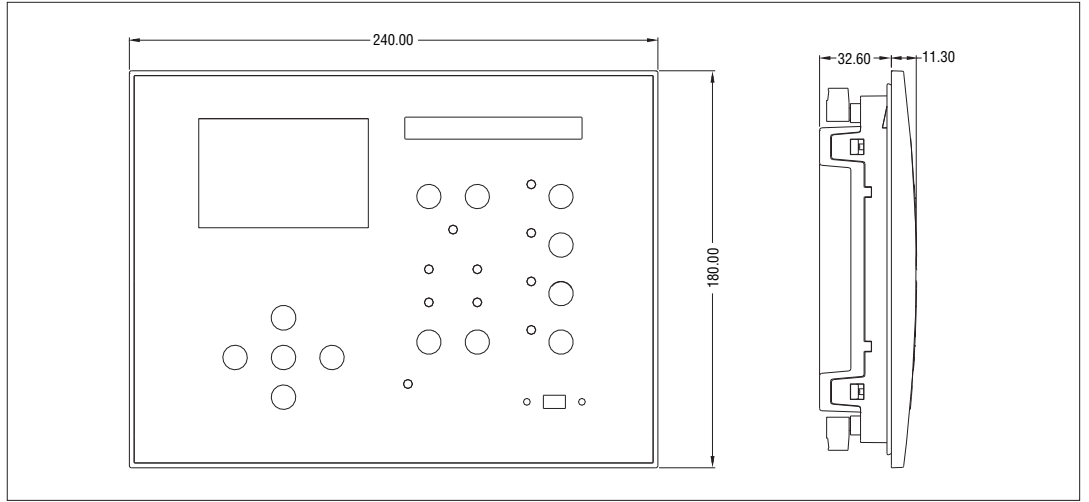

CUTOUT (mm)

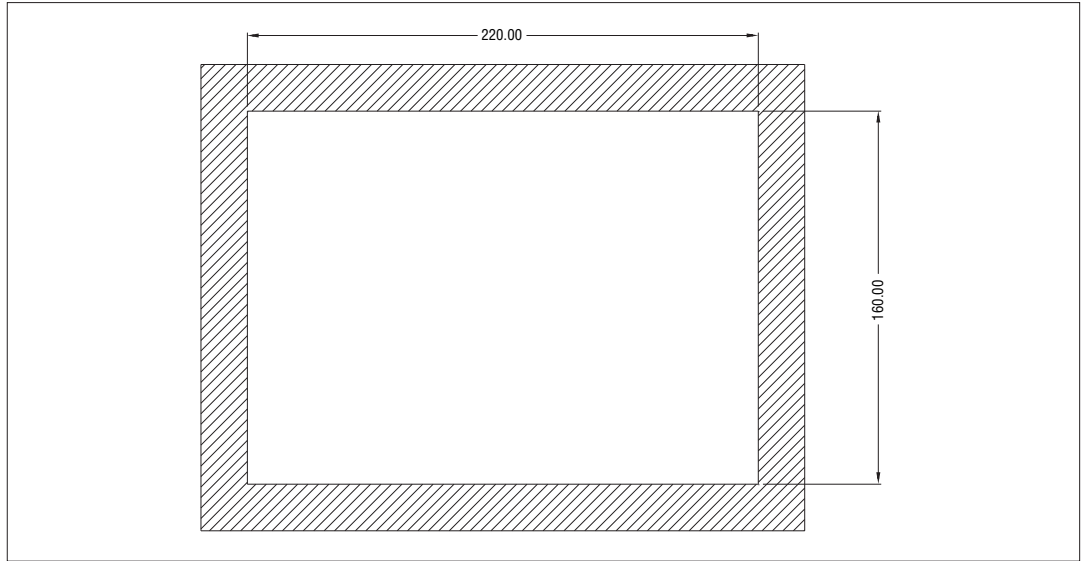

TECHNICAL CHARACTERISTICS

Supply		
Battery rated voltage	12 or 24V= indifferently	
Maximum current consumption	400mA at 12V= and 200mA at 24V=	
Maximum power consumption/dissipation	4.8W	
Voltage range	7...33V=	
Minimum voltage at the starting	5.5V=	
Stand-by current	70mA at 12V= and 40mA at 24V=	
Micro interruption immunity	150ms	
Digital inputs		
Input type	Negative	
Current input	≤10mA	
Input "low" voltage	≤1.5V (typical 2.9V)	
Input "high" voltage	≥5.3V (typical 4.3V)	
Input delay	≥50ms	
Analog inputs		
Pressure sensor	Current	10mA = max
	Measuring range	0 - 450Ω
Temperature sensor	Current	10mA = max
	Measuring range	0 - 1350Ω
Fuel level sensor	Current	10mA = max
	Measuring range	0 - 1350Ω
Speed input "W"		
Input type	AC coupling	
Voltage range	2.4...75Vpp	
Frequency range	40...2000Hz	
Pick-up input		
Input type	AC coupling	
Voltage range	High sensitivity:	1.6...60Vpp – 0.6...21VRMS
	Low sensitivity:	4.8...150Vpp – 1.7...53VRMS
Frequency range	20Hz...10000Hz	
Measuring input impedance	>100kΩ	
Engine running input (500rpm) for permanent magnet alternator		
Input type	AC coupling	
Voltage range	0...44V~	
Engine running input (500rpm) for pre-excited alternator		
Voltage range	0...44V=	
Maximum input current	12mA	
Maximum voltage at +D terminal	12 or 24V= (battery voltage)	
Pre-excitation current (42 terminal)	230mA 12V= – 130mA 24V=	
Mains and generator voltage inputs		
Maximum rated voltage Ue	600V~ L-L (346V~ L-N)	
Measuring range	50...720V L-L (415V~ L-N)	
Frequency range	45...65Hz – 360...440Hz	
Measuring method	True RMS	
Measuring input impedance	> 0.55MΩ L-N > 1,10MΩ L-L	
Wiring mode	Single-phase, two-phase, three-phase with or without neutral or balanced three-phase system.	
Current inputs		
Rated current Ie	1A~ or 5A~	
Measuring range	for 5A scale: 0.010 - 6A~ for 1A scale: 0.010 – 1.2A~	
Type of input	Shunt supplied by an external current transformer (low voltage). Max. 5A	
Measuring method	True RMS	
Overload capacity	+20% Ie	
Overload peak	50A for 1 second	
Power consumption	<0.6VA	
Measuring accuracy		
Mains and generator voltage	±0.25% f.s. ±1digit	
SSR output OUT1 and OUT 2 (+ battery voltage output)		
Type of output	2 x 1 NO + one common terminal	
Rated voltage	12-24V= from battery	
Rated current	2A DC1 each	
Protection	Overload, short circuit and reverse polarity	

SSR output OUT3 - OUT 4 (+ battery voltage output)	
Type of output	4 x 1 NO + one common terminal
Rated voltage	12-24V= from battery
Rated current	2A DC1 each
Protection	Overload, short circuit and reverse polarity
Relay output OUT 8 (voltage free)	
Type of contact	1 changeover
UL Rating	B300 / 30V= 1A Pilot Duty
Rated voltage	250V~
Rated current at 250VAC	8A AC1 (1,5A AC15)
Relay output OUT 9 (voltage free)	
Type of contact	1 NC (mains contactor)
UL Rating	B300 / 30V= 1A Pilot Duty
Rated voltage	250V~ (400V~ max)
Rated current at 250VAC	8A AC1 (1,5A AC15)
Relay output OUT 10 (voltage free)	
Type of contact	1 NO (generator contactor)
UL Rating	B300 / 30V= 1A Pilot Duty
Rated voltage	250V~ (400V~ max)
Rated current at 250VAC	8A AC1 (1,5A AC15)
Communication Lines	
RS232 Serial interface	Not isolated
Baud-rate	programmable 1200...115200 bps
CAN bus interface	Not isolated
Insulation	
Rated insulation voltage Ui	600V~
Rated impulse withstand voltage Uimp	9.5kV
Power frequency withstand voltage	5,2kV
Ambient conditions	
Operating temperature	-30 - +70°C
Storage temperature	-30 - +80°C
Relative humidity	<80% (IEC/EN 60068-2-78)
Maximum pollution degree	2
Overvoltage category	3
Measurement category	III
Climatic sequence	Z/ABDM (IEC/EN 60068-2-61)
Shock resistance	15g (IEC/EN 60068-2-27)
Vibration resistance	0.7g (IEC/EN 60068-2-6)
Connections	
Terminal type	Plug-in / removable
Conductor cross section (min... max)	0.2...2.5 mm ² (24...12 AWG)
Tightening torque	0.56 Nm (5 lbin)
Housing	
Version	Flush mount
Material	Polycarbonate
Degree of protection	IP65 on front – IP20 terminals
Weight	880g for RGK700; 900g for RGK700SA
Certifications and compliance	
Certifications obtained	cULus
UL Marking	Use 60°C/75°C copper (CU) conductor only AWG Range: 24 - 12 AWG stranded or solid Field Wiring Terminals Tightening Torque: 5lb.in For use on a flat surface of a type 4X enclosure Tightening torque used for fixing screw =0.5Nm
Comply with standards	IEC/EN 61010-1, IEC/EN 61000-6-2, IEC/EN 61000-6-3, UL508, CSA C22.2 N°14