

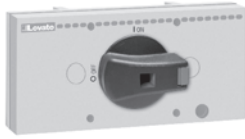

LOVATO ELECTRIC S.P.A.

24020 GORLE (BERGAMO) ITALIA
VIA DON E. MAZZA, 12
TEL. 035 4282111
E-mail info@LovatoElectric.com
Web www.LovatoElectric.com

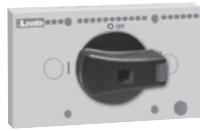

I INTERBLOCCO MECCANICO E SISTEMA UNIONE MECCANICA
GB MECHANICAL INTERLOCK AND MECHANICAL COUPLING SYSTEM
D MECHANISCHE VERRIEGELUNG UND MECANISCHE VERBINDUNGSSYSTEM
F VERROUILLAGE MECANIQUE ET SYSTEME MECANIQUE D'ACCOUPLLEMENT
E ENCLAVAMIENTO MECÁNICO Y SISTEMA DE UNIÓN MECÁNICA
GAX50... - GAX67B - GAX60...



WARNING!

- This equipment is to be installed by qualified personnel, complying to current standards, to avoid damages or safety hazards.
- The manufacturer cannot be held responsible for electrical safety in case of improper use of the equipment.
- Products illustrated herein are subject to alteration and changes without prior notice. Technical data and descriptions in the documentation are accurate, to the best of our knowledge, but no liabilities for errors, omissions or contingencies arising there from are accepted.



ATTENTION !

- Ces appareils doivent être installés par un personnel qualifié, conformément aux normes en vigueur en matière d'installations, afin d'éviter de causer des dommages à des personnes ou choses.
- Le constructeur n'assume aucune responsabilité quant à la sécurité électrique en cas d'utilisation impropre du dispositif.
- Les produits décrits dans ce document sont susceptibles d'évoluer ou de subir des modifications à n'importe quel moment. Les descriptions et caractéristiques techniques du catalogue ne peuvent donc avoir aucune valeur contractuelle.



ACHTUNG!

- Zur Vermeidung von Personen- und Sachschäden dürfen diese Geräte nur von qualifiziertem Fachpersonal und unter Befolgung der einschlägigen Vorschriften installiert werden.
- Bei zweckwidrigem Gebrauch der Vorrichtung übernimmt der Hersteller keine Haftung für die elektrische Sicherheit.
- Die in dieser Broschüre beschriebenen Produkte können jederzeit weiterentwickelt und geändert werden. Die im Katalog enthaltenen Beschreibungen und Daten sind daher unverbindlich und ohne Gewähr.



ADVERTENCIA

- Este dispositivo debe ser instalado por personal cualificado conforme a la normativa de instalación vigente a fin de evitar daños personales o materiales.
- El fabricante no se responsabilizará de la seguridad eléctrica en caso de que el dispositivo no se utilice de forma adecuada.
- Los productos descritos en este documento se pueden actualizar o modificar en cualquier momento. Por consiguiente, las descripciones y los datos técnicos aquí contenidos no tienen valor contractual.



UPOZORNĚNÍ

- Tato zařízení smí instalovat kvalifikovaní pracovníci v souladu s platnými předpisy a normami pro předcházení úrazů osob či poškození věcí.
- Výrobce nenese odpovědnost za elektrickou bezpečnost v případě nevhodného používání regulátoru.
- Výrobky popsané v tomto dokumentu mohou kdykoli projít úpravami či dalším vývojem. Popisy a údaje uvedené v katalogu nemají proto žádnou smluvní hodnotu.



AVERTIZARE!

- Acest echipament va fi instalat de personal calificat, în conformitate cu standardele actuale, pentru a evita deteriorări sau pericolele.
- Producătorul nu poate fi considerat responsabil pentru siguranța electrică în caz de utilizare incorectă a echipamentului.
- Produsele ilustrate în prezentul sunt supuse modificărilor și schimbărilor fără notificare anterioară. Datele tehnice și descrierile din documentație sunt precise, în măsura cunoștințelor noastre, dar nu se acceptă nicio răspundere pentru erorile, omisiunile sau evenimentele neprevăzute care apar ca urmare a acestora.



ATTENZIONE!

- Questi apparecchi devono essere installati da personale qualificato, nel rispetto delle vigenti normative impiantistiche, allo scopo di evitare danni a persone o cose.
- Il costruttore non si assume responsabilità in merito alla sicurezza elettrica in caso di utilizzo improprio del dispositivo.
- I prodotti descritti in questo documento sono suscettibili in qualsiasi momento di evoluzioni o di modifiche. Le descrizioni ed i dati a catalogo non possono pertanto avere alcun valore contrattuale.



UWAGA!

- W celu uniknięcia obrażeń osób lub uszkodzenia mienia tego typu urządzenia muszą być instalowane przez wykwalifikowany personel, zgodnie z obowiązującymi przepisami.
- Producent nie przyjmuje na siebie odpowiedzialności za bezpieczeństwo elektryczne w przypadku niewłaściwego użytkowania urządzenia.
- Produkty opisane w niniejszym dokumencie mogą być w każdej chwili udoskonalone lub zmodyfikowane. Opisy oraz dane katalogowe nie mogą mieć w związku z tym żadnej wartości umownej.



注意

- 本设备只能由合格人员根据现行标准进行安装。严禁损坏或安全危害。
- 制造商不负责因设备使用不当导致的电气安全问题。
- 产品说明如有变动和变化，恕不另行通知。我们竭力确保技术数据和描述是准确的，但对错误、遗漏或由此引起的意外事件概不负责。



ПРЕДУПРЕЖДЕНИЕ!

- Во избежание травм или материального ущерба монтаж должен осуществляться только квалифицированным персоналом в соответствии с действующими нормативами.
- Производитель не несет ответственность за обеспечение электробезопасности в случае ненадлежащего использования устройства.
- Изделия, описанные в настоящем документе, в любой момент могут подвергнуться изменениям или усовершенствованиям. Поэтому каталожные данные и описания не могут рассматриваться как действительные с точки зрения контрактов



DİKKAT!

- Bu aparatlar kişilere veya nesnelere zarar verme ihtimaline karşı yürürlükte olan sistem kurma normlarına göre kalifiye personel tarafından monte edilmelidir.
- Üretici aparatın hatalı kullanımından kaynaklanan elektriksel güvenliği ait sorumluluk kabul etmez.
- Bu dokümanda tarif edilen ürünler her an evrimlere veya değişimlere açıktır. Bu sebeple katalogdaki tarif ve değerler herhangi bir bağlayıcı değeri haiz değildir.



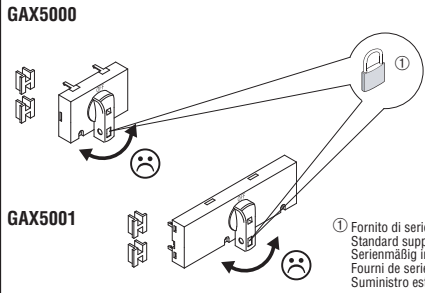

① Fornito di serie con posizione O-OFF bloccata.
Standard supplied with position locked at O-OFF.
Serienmäßig in verschlossen O-OFF-Position geliefert.
Fourni de serie en position O-OFF verrouillée.
Suministro estandar con la posición bloqueada en O-OFF.

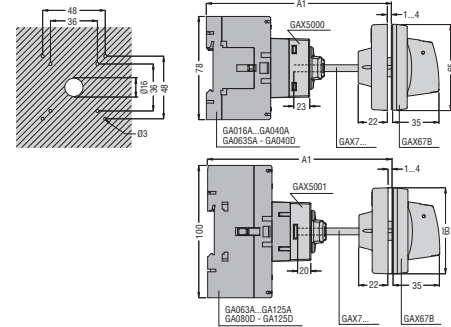
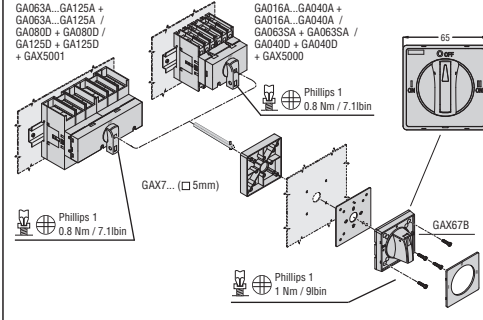
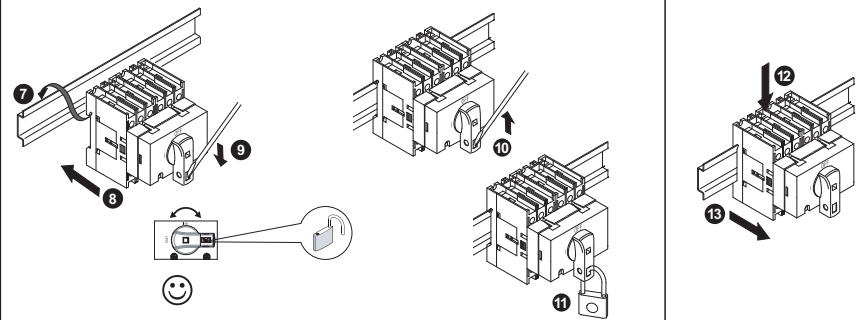
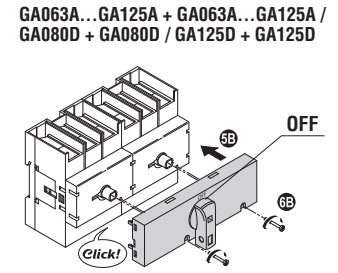
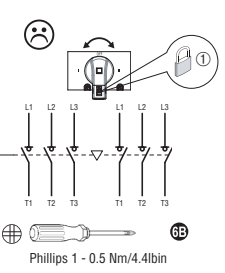
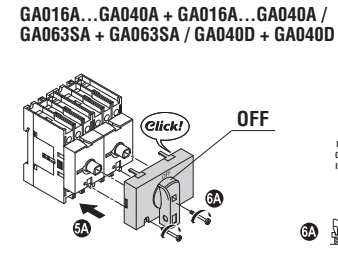
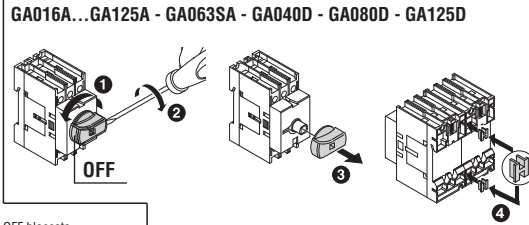

GAX7...	A1 [mm] max GAX5000/GAX5001 + GAX67B
GAX7055	114
GAX7070	129
GAX7090	149
GAX7150	209
GAX7200	259
GAX7300	359
GAX7400	459
GAX7500	559

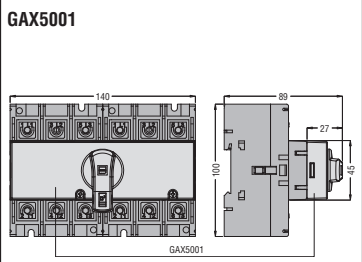
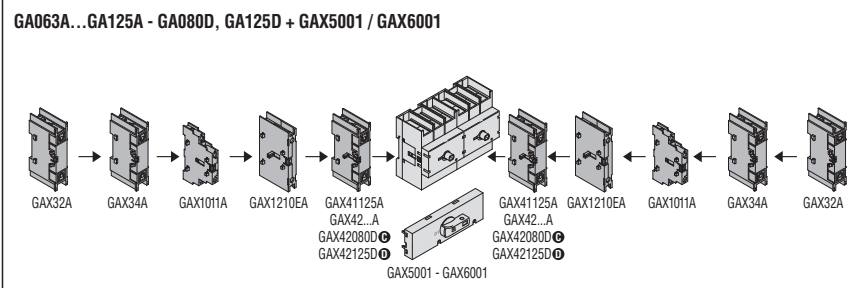
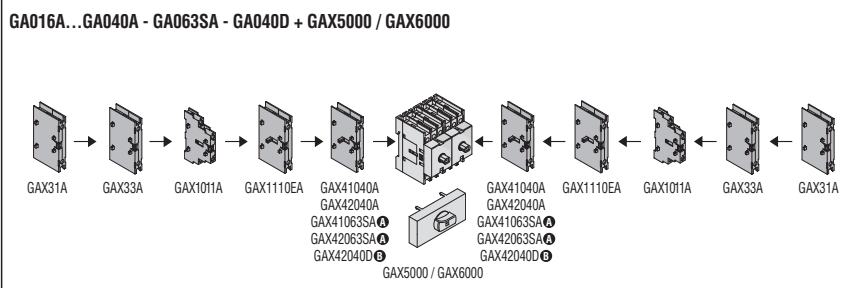
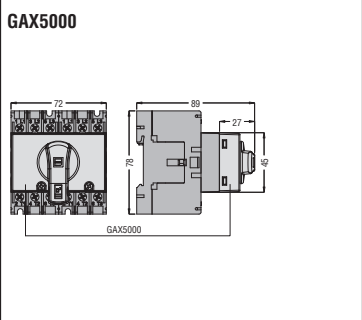

1	1	1	—	1	GA016A + GA016A	1	—	1	1	1
1	1	1	—	1	GA025A + GA025A	—	—	2	1	1
1	1	2	—	—	GA032A + GA032A	1	—	1	1	1
1	1	1	—	1	GA040A + GA040A	—	—	2	1	1
1	1	1	1	—	GA063SA + GA063SA	—	—	1	1	1
1	1	2	—	—	GA080D + GA080D	—	—	2	1	1
1	1	—	—	1	GA125D + GA125D	1	—	—	1	1
1	1	—	—	—		—	—	—	1	1

Ⓐ GAX41063SA → GA063SA - GAX42063SA → GA063SA.

Ⓑ GAX42040D → GA040D.

—	—	1	—	1	GA063A + GA063A	1	—	1	—	—
—	—	1	—	1	GA080A + GA080A	—	—	2	—	—
—	—	2	—	—	GA100A + GA100A	1	—	1	—	—
—	—	1	—	1	GA125A + GA125A	—	—	1	—	—
—	—	1	1	—	GA2080D + GA2080D	—	—	2	—	—
—	—	1	1	—	GA42125D + GA42125D	—	—	2	—	—
1	1	—	—	1		1	—	—	1	1
1	1	—	—	—		—	—	—	1	1

Ⓒ GAX42080D → GA080D.

Ⓓ GAX42125D → GA125D.

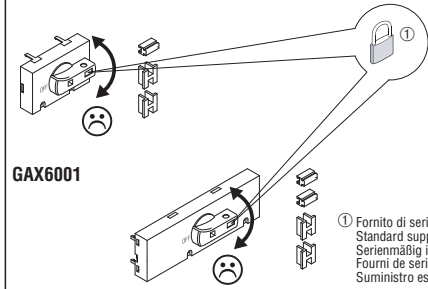
GAX6000**GAX6001**

① Fornito di serie con posizione O-OFF bloccata.
Standard supplied with position locked at O-OFF.
Serienmäßig in verschlossen O-OFF-Position geliefert.
Fourni de serie en position O-OFF verrouillée.
Suministro estandard con la posición bloqueada en O-OFF.

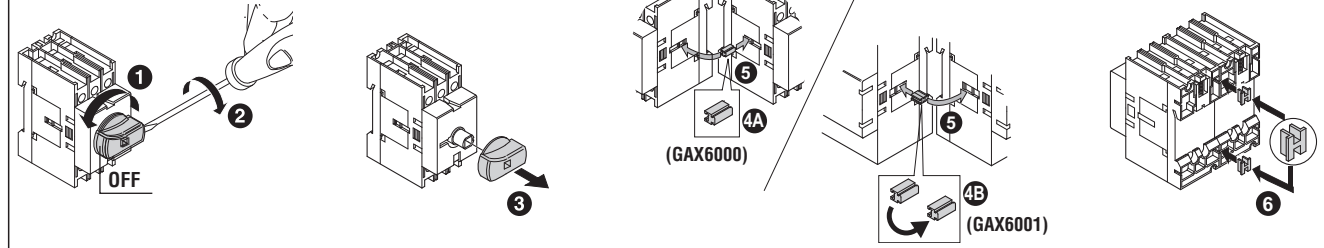
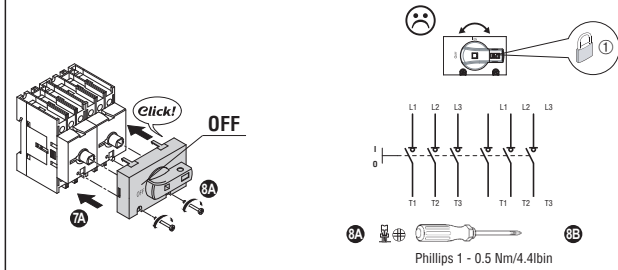
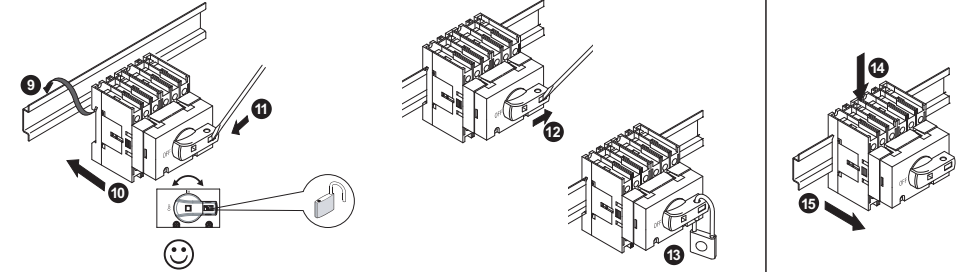
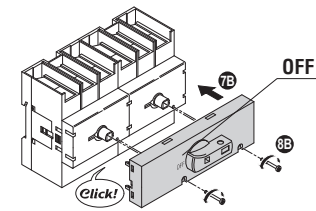
GA016A...GA125A - GA063SA - GA040D - GA080D - GA125D**GA016A...GA040A + GA016A...GA040A /
GA063SA + GA063SA / GA040D + GA040D****GA063A...GA125A + GA063A...GA125A /
GA080D + GA080D / GA125D + GA125D**

GA016A...GA040A + GA016A...GA040A / GA063SA + GA063SA / GA040D + GA040D + GAX6000

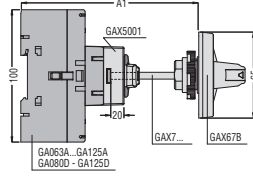
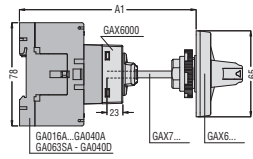
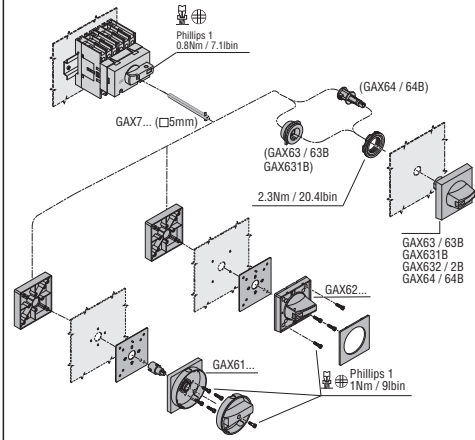

GAX7...	B [mm]	A1 [mm] max			
		GAX61...	GAX62...	GAX63...	GAX64...
GAX7055	55	116	114	119	133
GAX7070	70	131	129	134	148
GAX7090	90	151	149	154	168
GAX7150	150	211	209	214	228
GAX7200	200	261	259	264	278
GAX7300	300	361	359	364	378
GAX7400	400	461	459	464	468
GAX7500	500	561	559	564	578

GAX61/61B

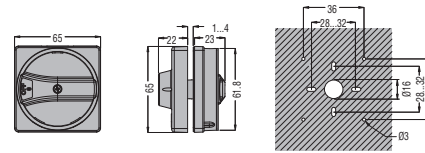

GAX62/62B

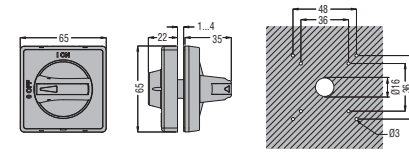

UL Marking: GAX61, GAX62, GAX63, GAX632, GAX64 for use on a flat surface, type 1, 4 and 4X, outdoor use.

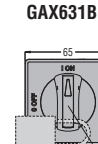
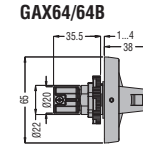
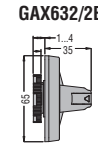
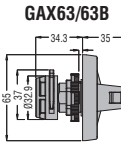
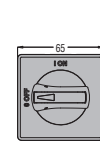

Secundo / Per / Nach / Selon / Segun UNI 5490, UNWEN 12465

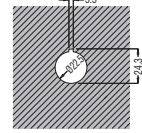

GAX7...

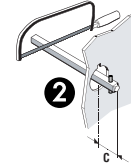
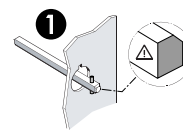
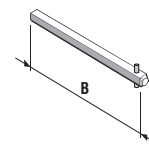

GAX6...	C [mm]
GAX61...	4
GAX62...	6
GAX63...	1
GAX64...	13

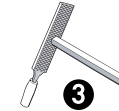

GA030A-GA063A...GA125A + GA063A...GA125A + GAX6001

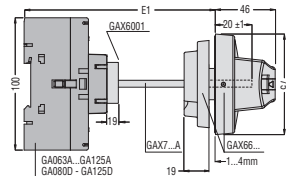
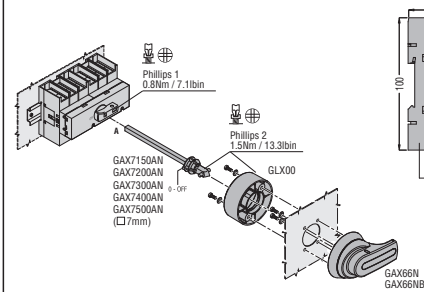

GAX66N/NB

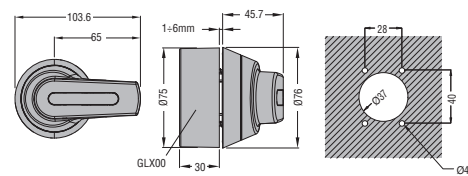

GAX7...AN

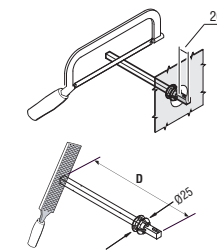

GAX7...AN	D	E
	[mm]	GAX66N/66NB [mm]
GAX7150AN	176	118...229
GAX7200AN	226	118...279
GAX7300AN	326	118...379
GAX7400AN	426	118...479
GAX7500AN	526	118...579

GAX6000

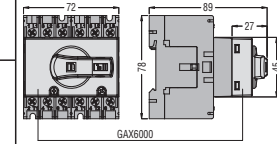

GAX6001

