

LOVATO ELECTRIC S.P.A.

 24020 GORLE (BERGAMO) ITALY
 VIA DON E. MAZZA, 12
 PHONE +39 035 4282111
 E-mail info@LovatoElectric.com
 Web www.LovatoElectric.com

- I** Relè allo stato solido
- GB** Solid state relays
- D** Halbleiterrelais (SSR)
- F** Relais Statiques
- E** Relés de estado sólido

HS...

WARNING!

- This equipment is to be installed by qualified personnel, complying to current standards, to avoid damages or safety hazards.
- The manufacturer cannot be held responsible for electrical safety in case of improper use of the equipment.
- Products illustrated herein are subject to alteration and changes without prior notice. Technical data and descriptions in the documentation are accurate, to the best of our knowledge, but no liabilities for errors, omissions or contingencies arising there from are accepted.

ATTENTION !

- Ces appareils doivent être installés par un personnel qualifié, conformément aux normes en vigueur en matière d'installations, afin d'éviter de causer des dommages à des personnes ou choses.
- Le constructeur n'assume aucune responsabilité quant à la sécurité électrique en cas d'utilisation impropre du dispositif.
- Les produits décrits dans ce document sont susceptibles d'évoluer ou de subir des modifications à n'importe quel moment. Les descriptions et caractéristiques techniques du catalogue ne peuvent donc avoir aucune valeur contractuelle.

ACHTUNG!

- Zur Vermeidung von Personen- und Sachschäden dürfen diese Geräte nur von qualifiziertem Fachpersonal und unter Befolgung der einschlägigen Vorschriften installiert werden.
- Bei zweckwidrigem Gebrauch der Vorrichtung übernimmt der Hersteller keine Haftung für die elektrische Sicherheit.
- Die in dieser Broschüre beschriebenen Produkte können jederzeit weiterentwickelt und geändert werden. Die im Katalog enthaltenen Beschreibungen und Daten sind daher unverbindlich und ohne Gewähr.

ADVERTENCIA

- Este dispositivo debe ser instalado por personal cualificado conforme a la normativa de instalación vigente a fin de evitar daños personales o materiales.
- El fabricante no se responsabilizará de la seguridad eléctrica en caso de que el dispositivo no se utilice de forma adecuada.
- Los productos descritos en este documento se pueden actualizar o modificar en cualquier momento. Por consiguiente, las descripciones y los datos técnicos aquí contenidos no tienen valor contractual.

UPOZORNĚNÍ

- Tato zařízení smí instalovat kvalifikovaní pracovníci v souladu s platnými předpisy a normami pro předcházení úrazů osob či poškození věcí.
- Výrobce nenese odpovědnost za elektrickou bezpečnost v případě nevhodného používání regulátoru.
- Výrobky popsané v tomto dokumentu mohou kdykoli projít úpravami či dalším vývojem. Popisy a údaje uvedené v katalogu nemají proto žádnou smluvní hodnotu.

AVERTIZARE!

- Acest echipament va fi instalat de personal calificat, în conformitate cu standardele actuale, pentru a evita deteriorări sau pericolele.
- Producătorul nu poate fi considerat responsabil pentru siguranța electrică în caz de utilizare incorectă a echipamentului.
- Produsele ilustrate în prezentul sunt supuse modificărilor și schimbărilor fără notificare anterioară. Datele tehnice și descrierile din documentație sunt precise, în măsura cunoștințelor noastre, dar nu se acceptă nicio răspundere pentru erorile, omisiunile sau evenimentele neprevăzute care apar ca urmare a acestora.

ATTENZIONE!

- Questi apparecchi devono essere installati da personale qualificato, nel rispetto delle vigenti normative impiantistiche, allo scopo di evitare danni a persone o cose.
- Il costruttore non si assume responsabilità in merito alla sicurezza elettrica in caso di utilizzo improprio del dispositivo.
- I prodotti descritti in questo documento sono suscettibili in qualsiasi momento di evoluzioni o di modifiche. Le descrizioni ed i dati a catalogo non possono pertanto avere alcun valore contrattuale.

UWAGA!

- W celu uniknięcia obrażeń osób lub uszkodzenia mienia tego typu urządzenia muszą być instalowane przez wykwalifikowany personel, zgodnie z obowiązującymi przepisami.
- Producent nie przyjmuje na siebie odpowiedzialności za bezpieczeństwo elektryczne w przypadku niewłaściwego użytkowania urządzenia.
- Produkty opisane w niniejszym dokumencie mogą być w każdej chwili udoskonalone lub zmodyfikowane. Opisy oraz dane katalogowe nie mogą mieć w związku z tym żadnej wartości umownej.

警告!

- 本设备只能由合格人员根据现行标准进行安装，以避免造成损坏或安全危害。
- 制造商不负责因设备使用不当导致的电气安全问题。
- 此处说明的产品可能会有变更，恕不提前通知。我们竭力确保本档中技术数据和说明的准确性，但对于错误、遗漏或由此产生的意外事件概不负责。

ПРЕДУПРЕЖДЕНИЕ!

- Во избежание травм или материального ущерба монтаж должен осуществляться только квалифицированным персоналом в соответствии с действующими нормативами.
- Производитель не несет ответственность за обеспечение электробезопасности в случае ненадлежащего использования устройства.
- Изделия, описанные в настоящем документе, в любой момент могут подвергнуться изменениям или усовершенствованиям. Поэтому каталожные данные и описания не могут рассматриваться как действительные с точки зрения контрактов



DİKKAT!

- Bu aparatlar kişilerle veya nesnelere zarar verme ihtimaline karşı yürürlükte olan sistem kurma normlarına göre kalifiye personel tarafından monte edilmelidir
- Üretici aparatın hatalı kullanımından kaynaklanan elektriksel güvenliğe ait sorumluluk kabul etmez.
- Bu dokümanda tarif edilen ürünler her an evrimlere veya değişimlere açıktır. Bu sebeple katalogdaki tarif ve değerler herhangi bir bağlayıcı değeri haiz değildir.

UPOZORENJE!

- Ovak uređaj mora instalirati, u skladu s važećim normama, obučena osoba kako bi se izbjegle štetne i sigurnosne opasnosti.
- Proizvođač ne snosi odgovornost za električnu sigurnost u slučaju nepravilnog korištenja opreme.
- Ovdje prikazan uređaj predmet je stalnog usavršavanja i promjena bez prethodne najave. Tehnički podaci i opisi u ovom uputama su točni, ali ne preuzimamo odgovornost za možebitne nenamjerne greške.

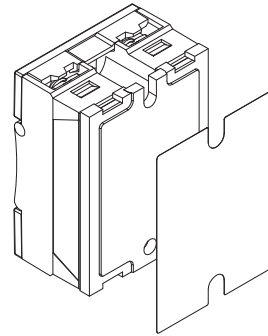
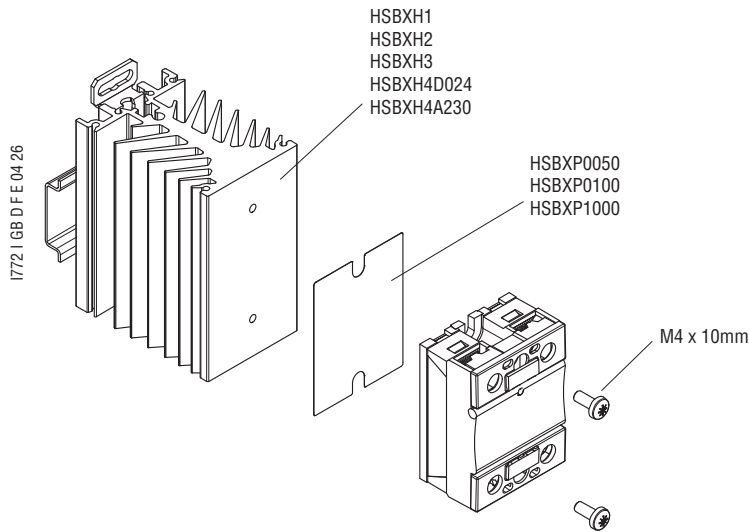

MOUNTING INSTRUCTIONS**HS1B..., HS2B...**

Apply Lovato thermal pad on the rear of the solid state relay for an optimal thermal dissipation of the heat through the heatsink or panel.

Applicare il pad termico Lovato sul retro del relè a stato solido per una dissipazione ottimale del calore attraverso il dissipatore o il pannello.

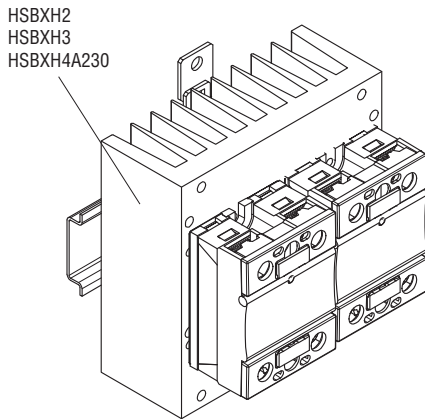

It is possible to mount two solid state relays on a single heatsink. In order to select the correct heatsink, the thermal power from both devices must be considered.

È possibile montare due relè allo stato solido su un unico dissipatore. Per selezionare il dissipatore corretto è necessario considerare la potenza termica di entrambi i dispositivi.

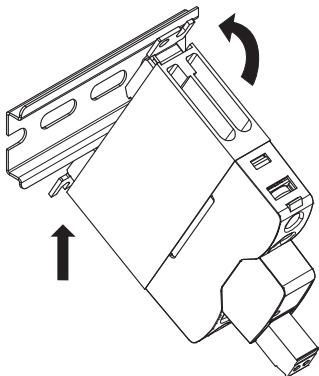
HS1C...020..., HS1C...025..., HS1C...30..., HS1C...040...

Put the lower hook of the fixing element on the DIN rail, push upwards and rotate to fix the product on the DIN rail.

Posizionare il gancio inferiore dell'elemento di fissaggio sulla guida DIN, spingere verso l'alto e ruotare il prodotto per fissarlo sulla guida DIN.

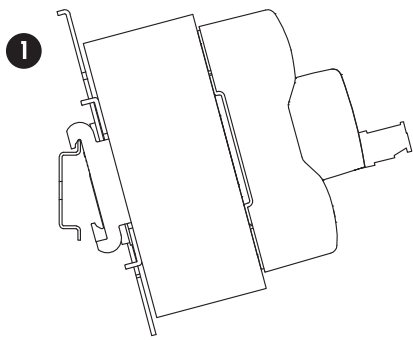

Put the upper hook of the fixing element on the DIN rail.

Posizionare il gancio superiore dell'elemento fissaggio sulla guida DIN.

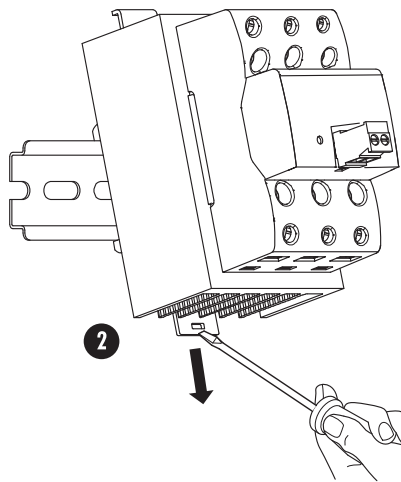

Pull the bottom lever downward with a screwdriver.

Tirare la leva inferiore verso il basso con un cacciavite.

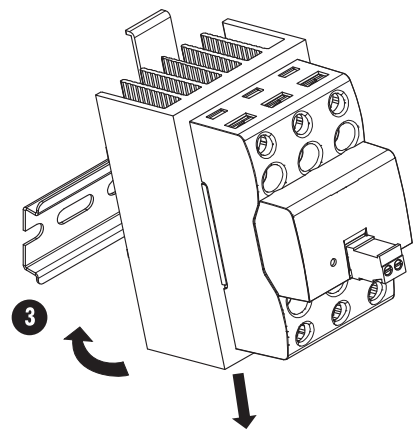

While keeping the lever down, rotate the product to fix it on the DIN rail.

Tenendo abbassata la leva, ruotare il prodotto per fissarlo sulla guida DIN.

SPACING / DISTANZE

HS1C..., HS2C..., HS3C...

Minimum clearances. For derating with $X=0\text{mm}$ (no distance between adjacent devices) see "DERATING CURVES" section.

Distanze minime. Per declassamento con $X=0\text{mm}$ (nessuna distanza tra dispositivi adiacenti) vedere la sezione "CURVE DI DERATING".

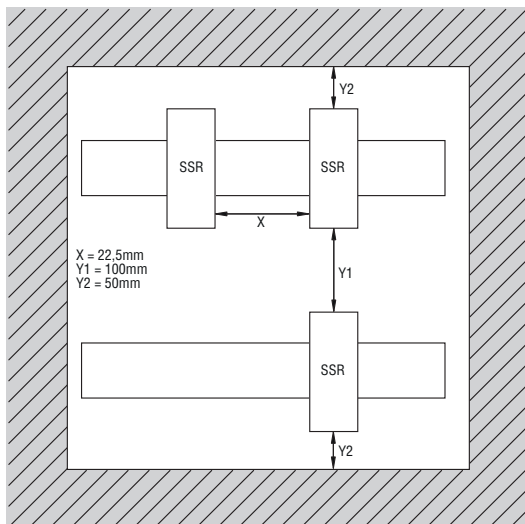

DERATING CURVES AND HEATSINK SELECTION

For more information on how to use the graphs, see the "HEATSINK SELECTION" section.

Miniature and hockey puck, single-phase

HS1ANN025D024, HS1B...

CURVE DI DECLASSAMENTO E SCELTA DEL DISSIPATORE

Per maggiori informazioni sull'utilizzo dei grafici consultare la sezione "SCELTA DEL DISSIPATORE".

Mini e hockey puck, monofase

HS1ANN025D024, HS1B...

1772 I GB D FE 04 26

HS1A2NN025D024

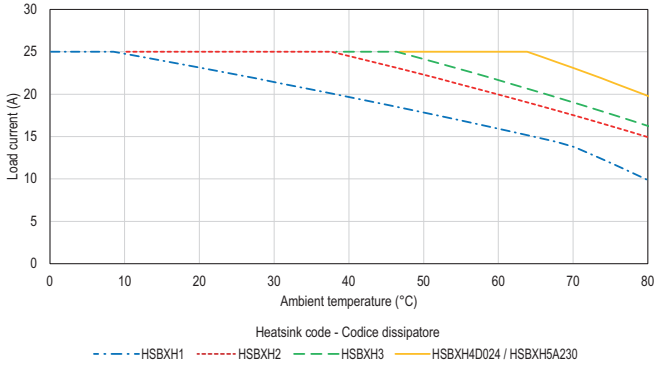

HS1B...025...

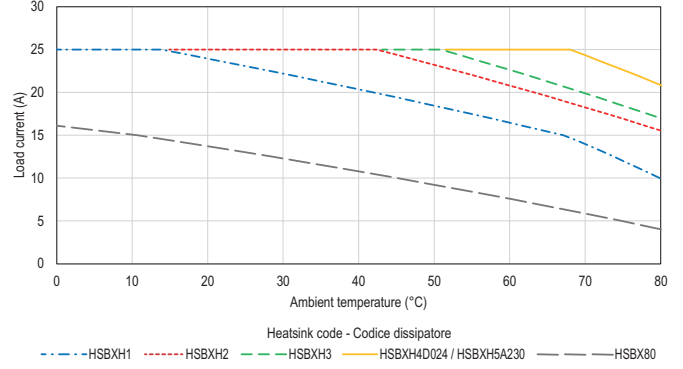

HS1B...040...

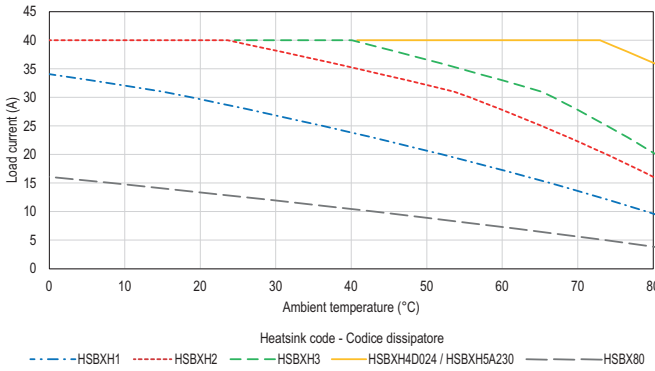

HS1B6NN050D024

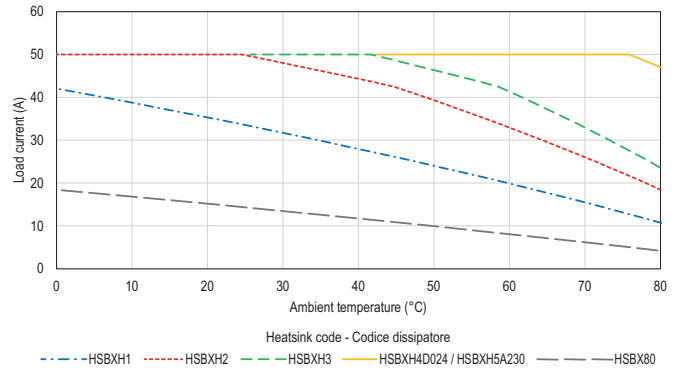

HS1B...060...

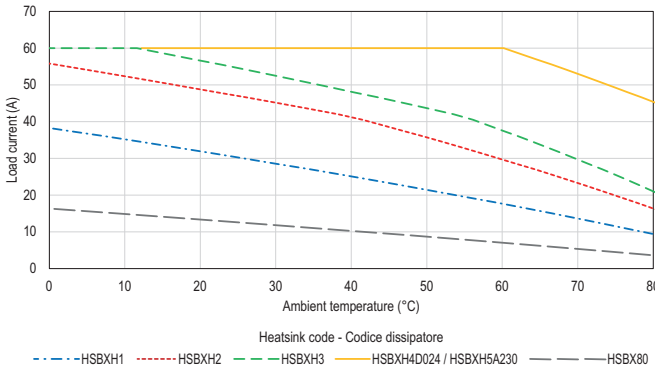

HS1B...090...

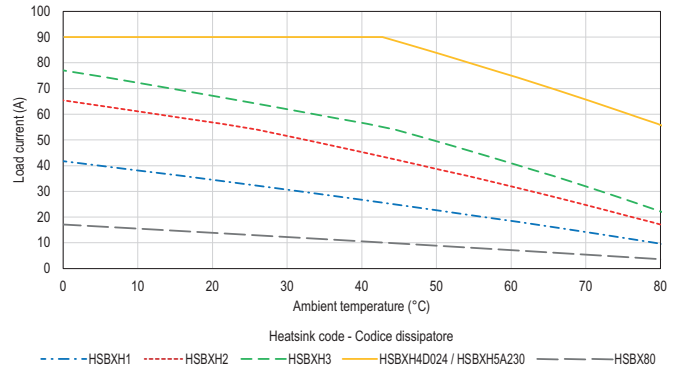

HS1B...130...

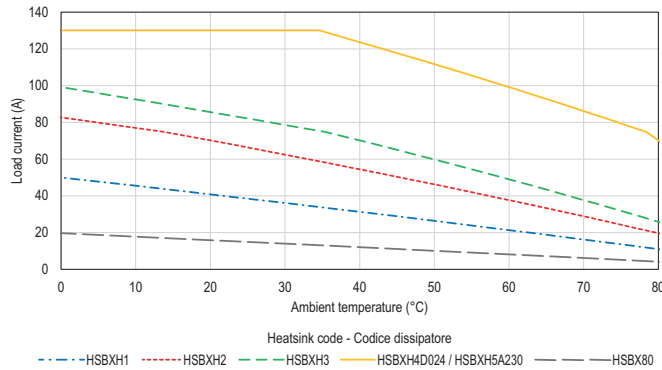

Hockey puck, two-phase

HS2B...

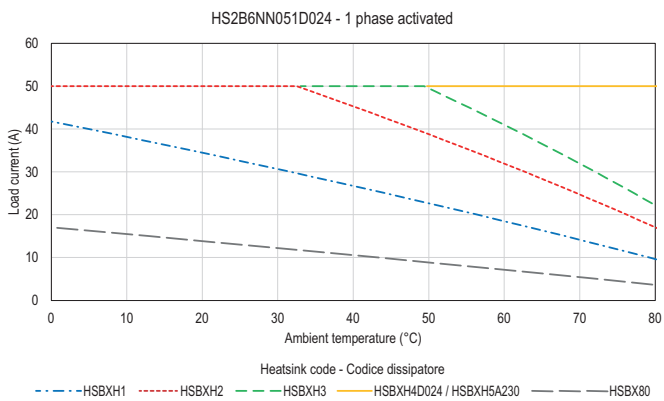
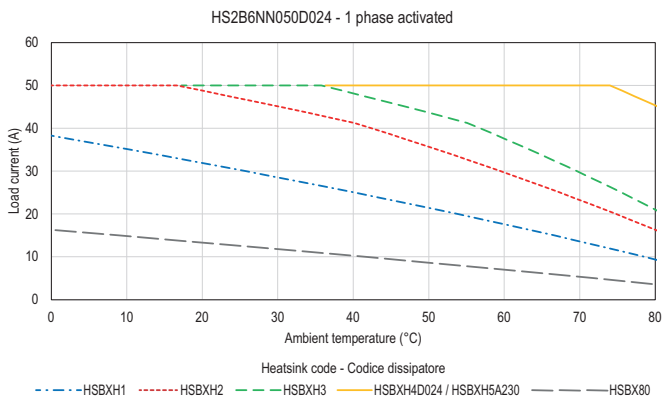
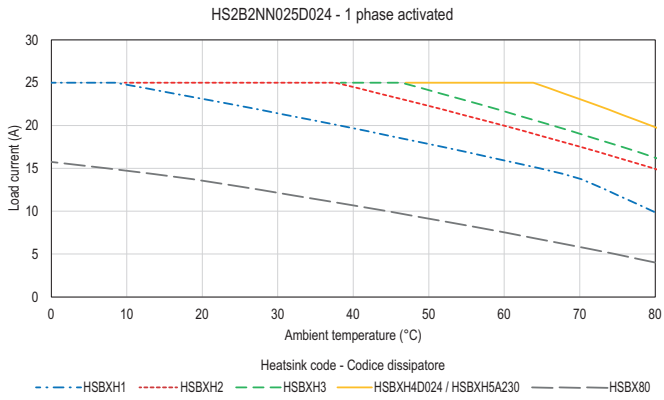

Hockey puck, bifase

HS2B...

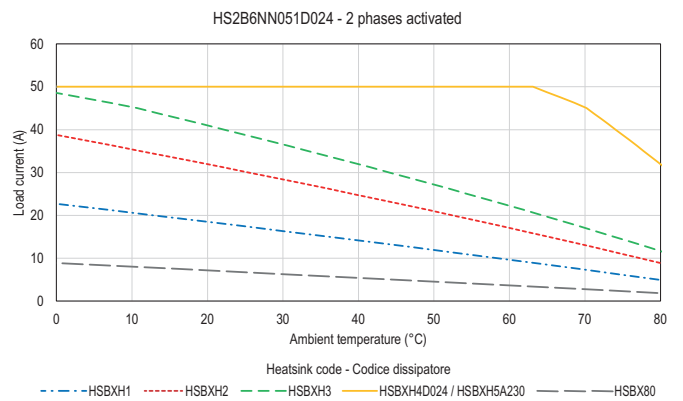
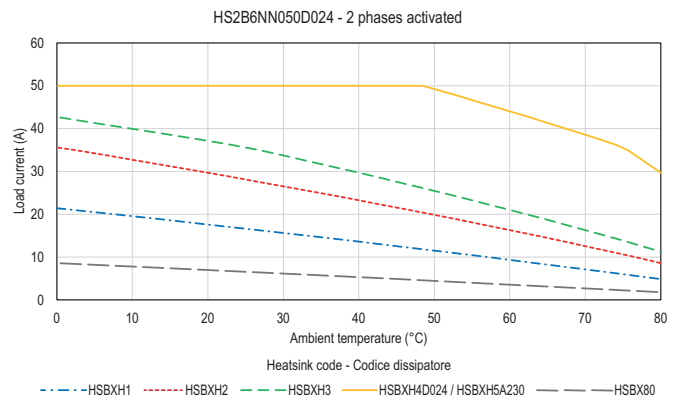
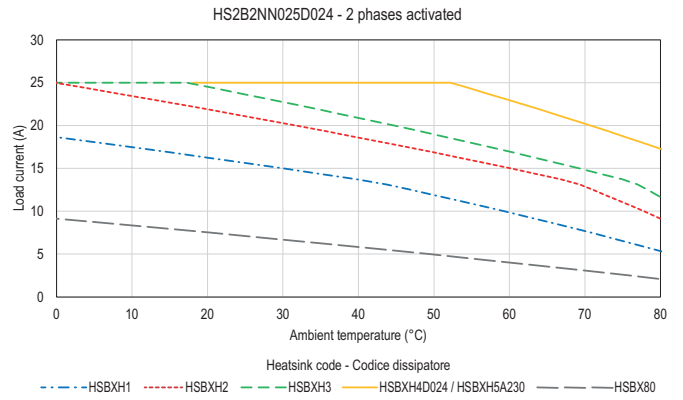

31100589 Complete with heatsink, single-phase
Derating curves with minimum distance between two adjacent devices of 22.5mm (minimum recommended distance) and 0mm (no distance).

Completo di dissipatore, monofase
Curve di derating con distanza minima tra due dispositivi adiacenti di 22.5mm (distanza minima consigliata) e di 0mm (nessuna distanza).
HS1C...

HS1C...

1772 I GB D FE 04 26

HS1C...020...

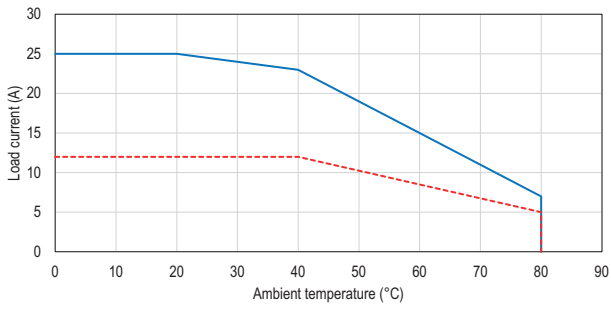

— With 22.5mm space between the devices - - - Without space between the devices (0mm)

HS1C...025...

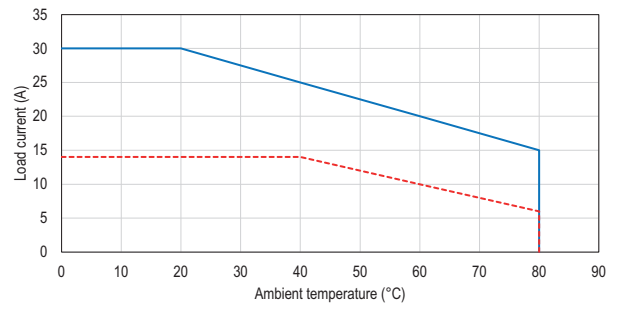

— With 22.5mm space between the devices - - - Without space between the devices (0mm)

HS1C...030...

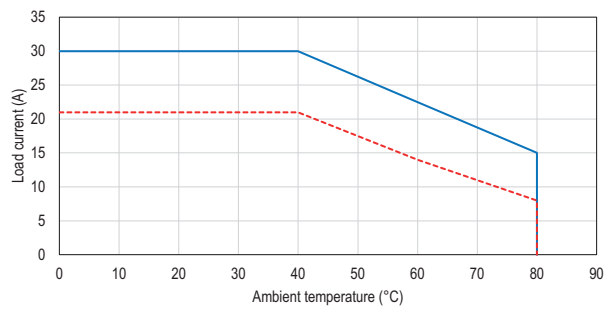

— With 22.5mm space between the devices - - - Without space between the devices (0mm)

HS1C...040...

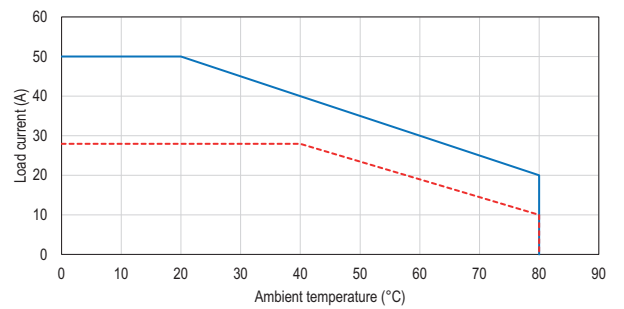

— With 22.5mm space between the devices - - - Without space between the devices (0mm)

HS1C...060...

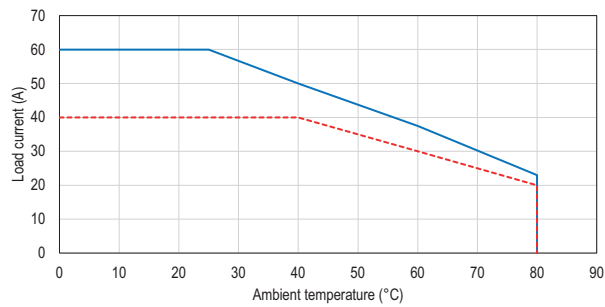

— With 22.5mm space between the devices - - - Without space between the devices (0mm)

Complete with heatsink, three-phase (2 controlled)
HS2C...

Completo di dissipatore, trifase (2 fasi controllate)
HS2C...

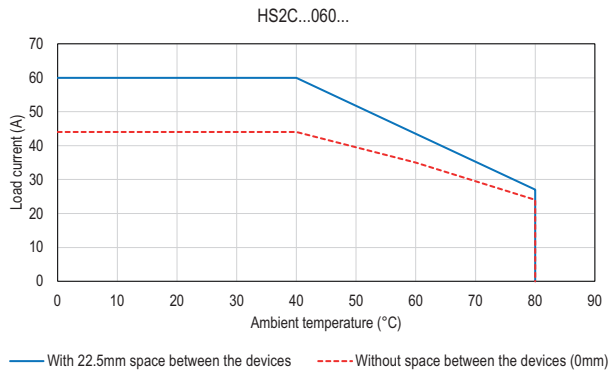
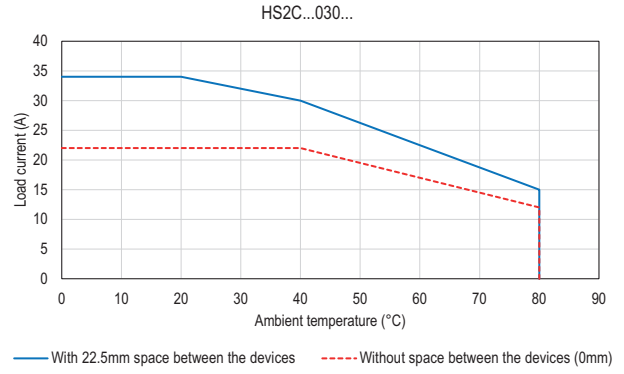
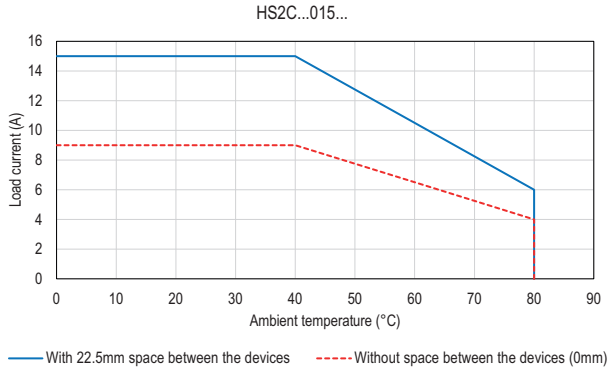

Complete with heatsink, three-phase (3-controlled)

HS3C..., HS3D...

Completo di dissipatore, trifase (3 fasi controllate)

HS3C..., HS3D...

HS3C...020...

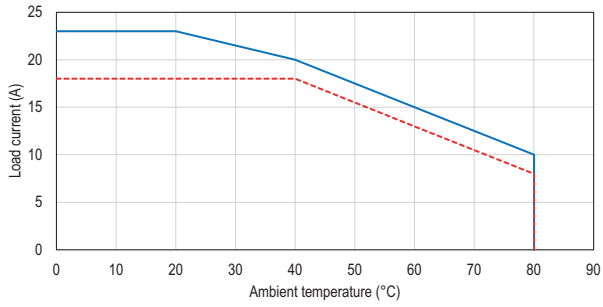

— With 22.5mm space between the devices - - - Without space between the devices (0mm)

HS3C...025...

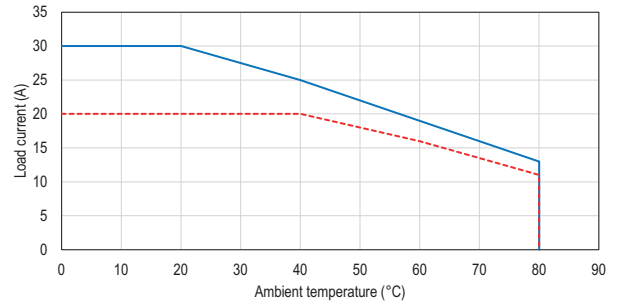

— With 22.5mm space between the devices - - - Without space between the devices (0mm)

HS3C...040...

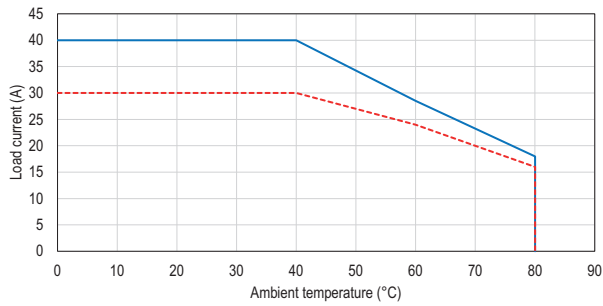

— With 22.5mm space between the devices - - - Without space between the devices (0mm)

HS3D5HV024E230

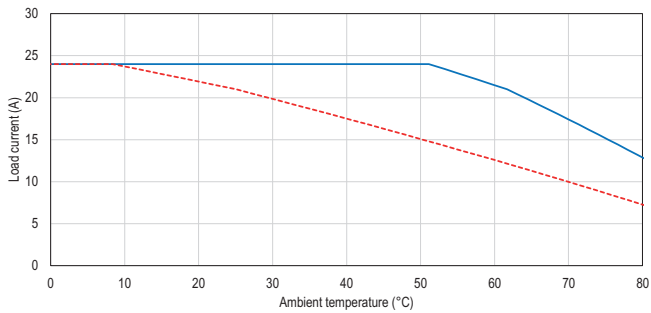

— ventilation on heatsink (> 1ms) - - - without ventilation

HS3D5HV048E230

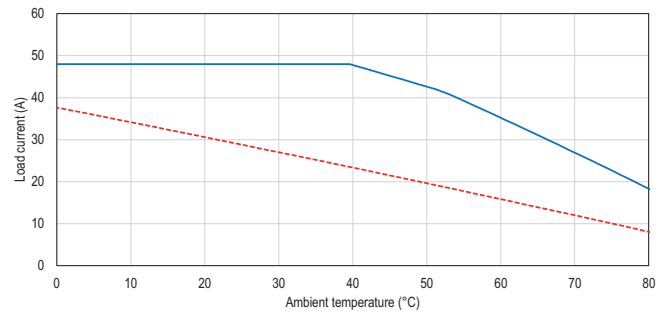

— ventilation on heatsink (> 1ms) - - - without ventilation

OUTPUT POWER DISSIPATION

Miniature and hockey puck, single-phase

HS1ANN025D024, HS1B...

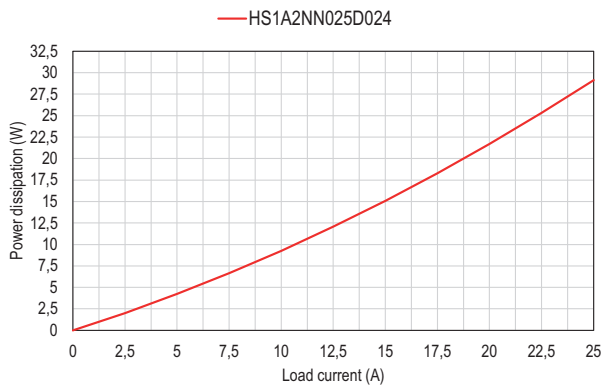

POTENZA DISSIPATA SULL'USCITA

Mini e hockey puck, monofase

HS1ANN025D024, HS1B...

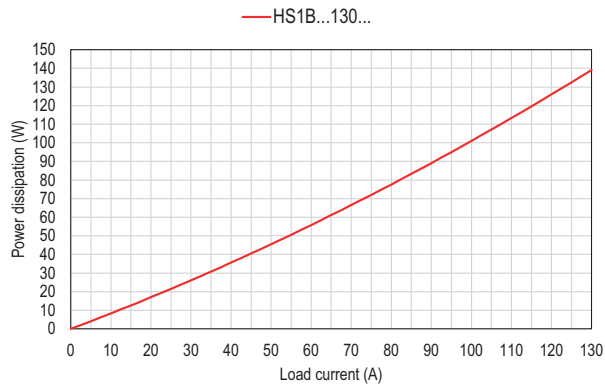
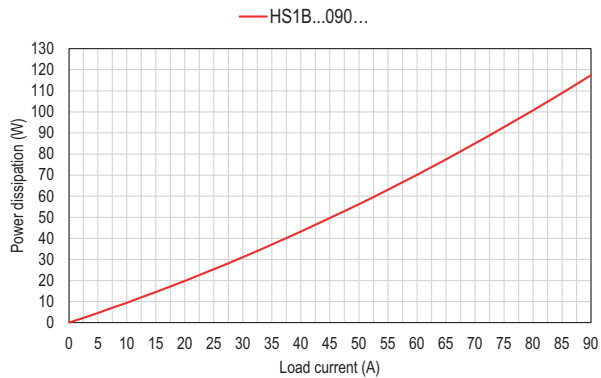
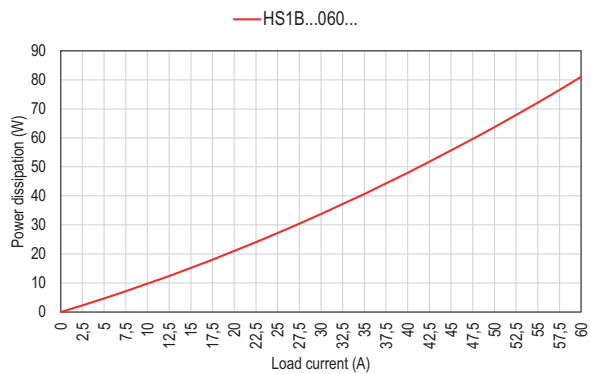
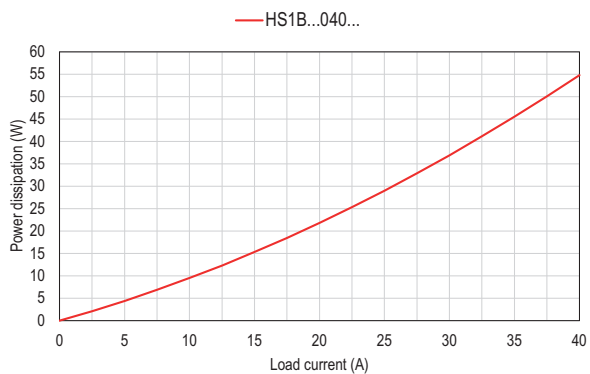
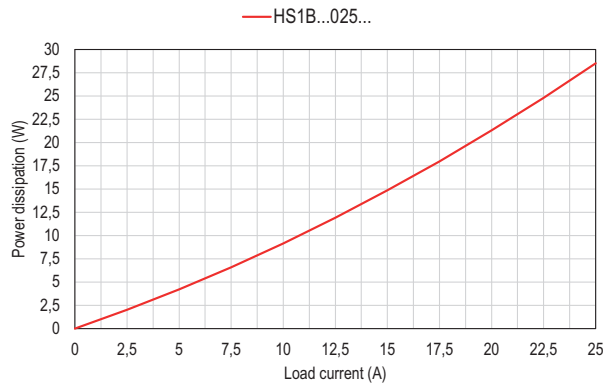

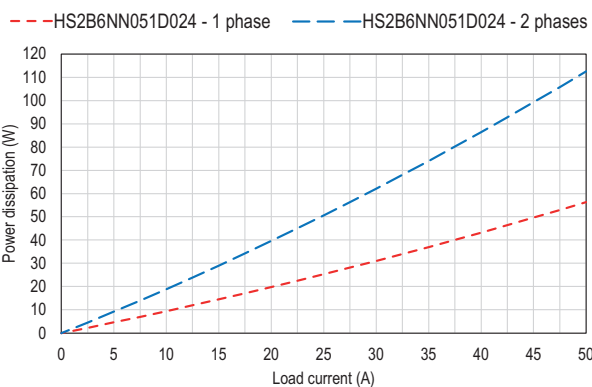
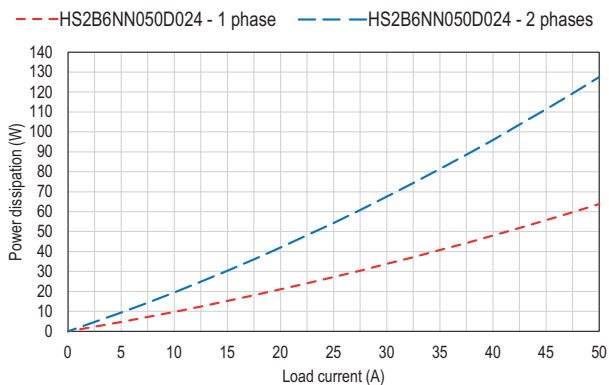
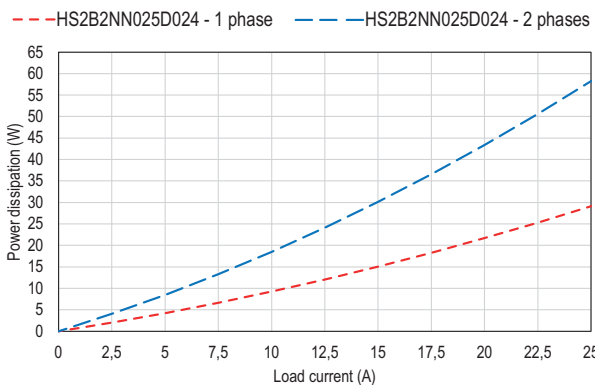

Complete with heatsink, single-phase, three-phase (2 controlled), three-phase (3 controlled)
HS1C..., HS2C..., HS3C...

Completo di dissipatore, monofase, trifase (2 fasi controllate), trifase (3 fasi controllate)
HS1C..., HS2C..., HS3C...

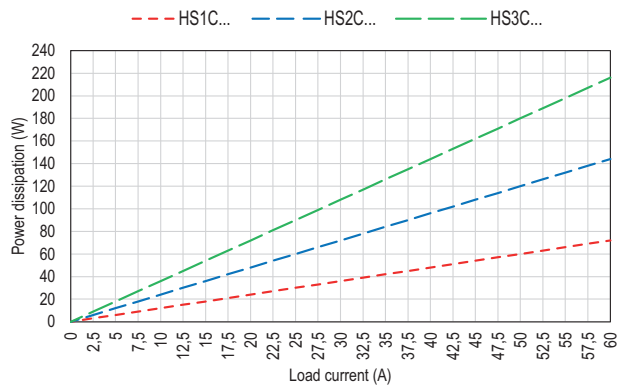

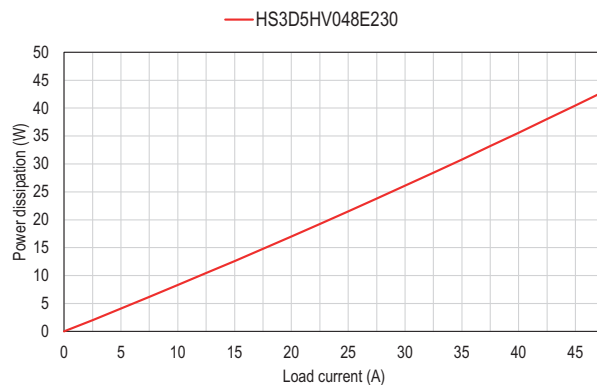
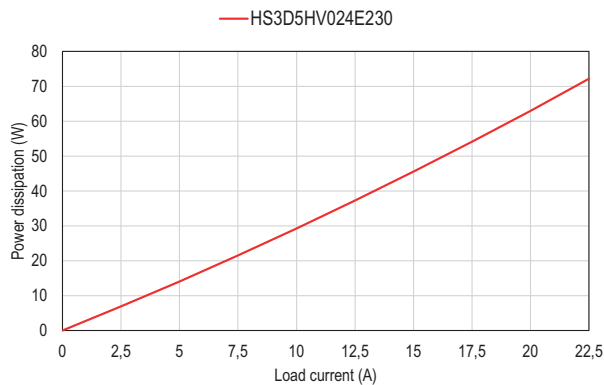

HEATSINK SELECTION

The proper heatsink can be selected from the thermal derating curves.

Select the heatsink from the thermal derating curves.

To do so, two values should be considered:

1. Load current (A)
2. Ambient temperature (°C)

Look at the thermal derating curves of the corresponding solid state relay and select the Lovato heatsink whose derating curve is just above your operating point. Consider the examples below.

For HS2B... two-phase hockey puck relays, two derating graphs are provided: one with only one phase active and one with both phases active simultaneously. When choosing a heatsink for HS2B..., consider the appropriate graph for your application based on whether both phases are active simultaneously.

Example 1

Heatsink selection for HS1B...25...:

1. Load current = 15A
2. Ambient temperature = 50°C

From the derating curve the proper heatsink is the HSBXH1.

SCelta DEL DISSIPATORE

Il dissipatore può essere scelto a partire dalle curve di declassamento termico.

Selezionare il dissipatore di calore dalle curve di declassamento termico.

Per fare ciò, è necessario considerare due valori:

1. Corrente del carico (A)
2. Temperatura ambiente (°C)

Dalle curve di declassamento termico del corrispondente relè a stato solido, selezionare il dissipatore Lovato la cui curva di declassamento è appena sopra il punto di funzionamento scelto. Di seguito si riportano alcuni esempi.

Per i relè hockey puck bifase HS2B..., vengono forniti due grafici di declassamento: uno con una sola fase attiva e uno con entrambe le fasi attive contemporaneamente. Quando si sceglie un dissipatore per gli HS2B..., è opportuno considerare il grafico corretto in base al numero di fasi attive contemporaneamente.

Esempio 1

Scelta del dissipatore per HS1B...25...:

1. Corrente di carico = 15 A
2. Temperatura ambiente = 50°C

Dalle curve di declassamento si sceglie il dissipatore HSBXH1.

HS1B...025...

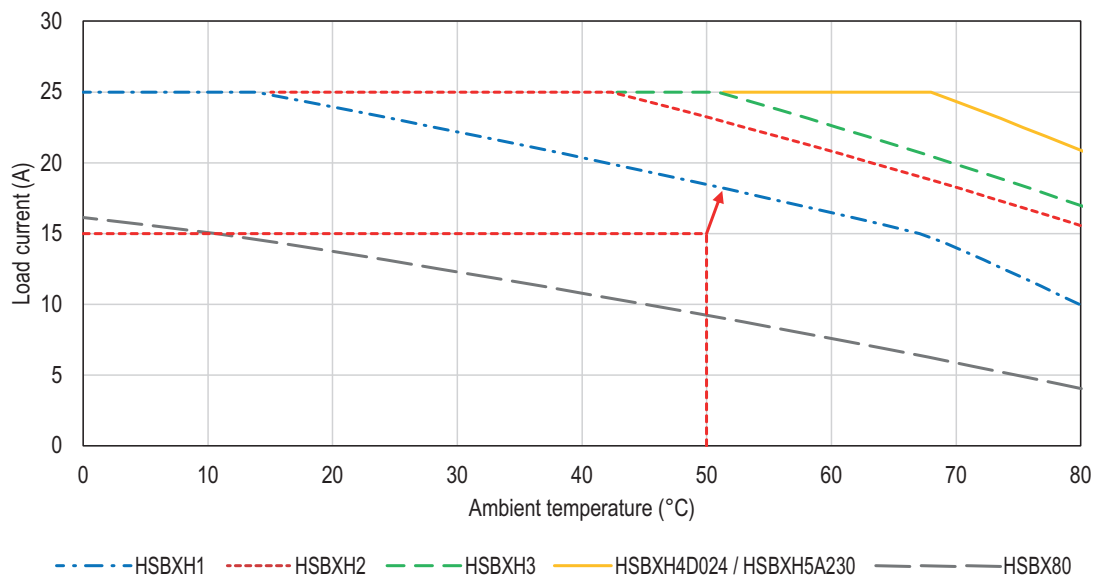

Example 2

Solid state relays are often used in applications that require frequent ON-OFF switching. In those cases, it is appropriate to consider also the duty cycle to select the proper heatsink. Consider an application with a load current of 50A and an ambient temperature of 40°C in which the solid state relay stays activated for 1s and it is turned off for 1s (TON=1s, TOFF=1s, Duty Cycle=0.5). The correct current to select the heatsink is the average current over the period: $I_{AVERAGE}=25A$. Let's select the solid state relay HS1B6NN050D024, from the derating curve below the correct heatsink for this application is HSBXH1. Note that this calculation is valid only when the solid state relay stays on for a short period of time, namely when TON is small.

Esempio 2

I relè a stato solido vengono spesso utilizzati in applicazioni con frequenti commutazioni ON-OFF. In questi casi è opportuno considerare anche il duty cycle per selezionare il dissipatore adeguato. Si consideri un'applicazione in cui il carico richiede una corrente di 50A e la temperatura ambiente è di 40°C, e in cui il relè allo stato solido rimane attivato per 1s e viene poi spento per 1s (TON=1s, TOFF=1s, Duty Cycle=0.5). La corrente da considerare per la scelta del dissipatore è la corrente media nel periodo: $I_{MEDIA}=25A$. Selezionando il relè a stato solido HS1B6NN050D024, guardando la curva di declassamento, il dissipatore corretto per l'applicazione è l'HSBXH1. Si noti che questo calcolo è valido solo quando il relè allo stato solido rimane acceso per un breve periodo di tempo, ovvero quando TON è piccolo.

HS1B6NN050D024

