



**WARNING!**

- Carefully read the manual before the installation or use.
- This equipment is to be installed by qualified personnel, complying to current standards, to avoid damages or safety hazards.
- Before any maintenance operation on the device, remove all the voltages from measuring and supply inputs and short-circuit the CT input terminals.
- The manufacturer cannot be held responsible for electrical safety in case of improper use of the equipment.
- Products illustrated herein are subject to alteration and changes without prior notice. Technical data and descriptions in the documentation are accurate, to the best of our knowledge, but no liabilities for errors, omissions or contingencies arising there from are accepted.
- A circuit breaker must be included in the electrical installation of the building. It must be installed close by the equipment and within easy reach of the operator. It must be marked as the disconnecting device of the equipment: IEC/EN 61010-1 § 6.11.3.1.
- Clean the device with a soft dry cloth; do not use abrasives, liquid detergents or solvents.



**ATTENTION !**

- Lire attentivement le manuel avant toute utilisation et installation.
- Ces appareils doivent être installés par un personnel qualifié, conformément aux normes en vigueur en matière d'installations, afin d'éviter de causer des dommages à des personnes ou choses.
- Avant toute intervention sur l'instrument, mettre les entrées de mesure et d'alimentation hors tension et court-circuiter les transformateurs de courant.
- Le constructeur n'assume aucune responsabilité quant à la sécurité électrique en cas d'utilisation impropre du dispositif.
- Les produits décrits dans ce document sont susceptibles d'évoluer ou de subir des modifications à n'importe quel moment. Les descriptions et caractéristiques techniques du catalogue ne peuvent donc avoir aucune valeur contractuelle.
- Un interrupteur ou disjoncteur doit être inclus dans l'installation électrique du bâtiment. Celui-ci doit se trouver tout près de l'appareil et l'opérateur doit pouvoir y accéder facilement. Il doit être marqué comme le dispositif d'interruption de l'appareil : IEC/EN 61010-1 § 6.11.3.1.
- Nettoyer l'appareil avec un chiffon doux, ne pas utiliser de produits abrasifs, détergents liquides ou solvants.



**ACHTUNG!**

- Dieses Handbuch vor Gebrauch und Installation aufmerksam lesen.
- Zur Vermeidung von Personen- und Sachschäden dürfen diese Geräte nur von qualifiziertem Fachpersonal und unter Befolgung der einschlägigen Vorschriften installiert werden.
- Vor jedem Eingriff am Instrument die Spannungszufuhr zu den Messingängen trennen und die Stromwandler kurzschließen.
- Bei zweckwidrigem Gebrauch der Vorrichtung übernimmt der Hersteller keine Haftung für die elektrische Sicherheit.
- Die in dieser Broschüre beschriebenen Produkte können jederzeit weiterentwickelt und geändert werden. Die im Katalog enthaltenen Beschreibungen und Daten sind daher unverbindlich und ohne Gewähr.
- In die elektrische Anlage des Gebäudes ist ein Ausschalter oder Trennschalter einzubauen. Dieser muss sich in unmittelbarer Nähe des Geräts befinden und vom Bediener leicht zugänglich sein. Er muss als Trennvorrichtung für das Gerät gekennzeichnet sein: IEC/EN 61010-1 § 6.11.3.1.
- Das Gerät mit einem weichen Tuch reinigen, keine Scheuermittel, Flüssigreiniger oder Lösungsmittel verwenden.



**ADVERTENCIA**

- Leer atentamente el manual antes de instalar y utilizar el regulador.
- Este dispositivo debe ser instalado por personal cualificado conforme a la normativa de instalación vigente a fin de evitar daños personales o materiales.
- Antes de realizar cualquier operación en el dispositivo, desconectar la corriente de las entradas de alimentación y medida, y cortocircuitar los transformadores de corriente.
- El fabricante no se responsabilizará de la seguridad eléctrica en caso de que el dispositivo no se utilice de forma adecuada.
- Los productos descritos en este documento se pueden actualizar o modificar en cualquier momento. Por consiguiente, las descripciones y los datos técnicos aquí contenidos no tienen valor contractual.
- La instalación eléctrica del edificio debe disponer de un interruptor o disyuntor. Este debe encontrarse cerca del dispositivo, en un lugar al que el usuario pueda acceder con facilidad. Además, debe llevar el mismo marcado que el interruptor del dispositivo (IEC/EN 61010-1 § 6.11.3.1).
- Limpiar el dispositivo con un trapo suave; no utilizar productos abrasivos, detergentes líquidos ni disolventes.



**UPOZORNĚNÍ**

- Návod se pozorně pročtěte, než začnete regulátor instalovat a používat.
- Tato zařízení smí instalovat kvalifikovaní pracovníci v souladu s platnými předpisy a normami pro předcházení úrazu osob či poškození věcí.
- Před jakýmkoli zásahem do přístroje odpojte měřicí a napájecí vstupy od napětí a zkratujte transformátory proudu.
- Výrobce nenese odpovědnost za elektrickou bezpečnost v případě nevhodného používání regulátoru.
- Výrobky popsané v tomto dokumentu mohou kdykoli projít úpravami či dalším vývojem. Popisy a údaje uvedené v katalogu nemají proto žádnou smluvní hodnotu.
- Spínač či odpojovač je nutno zabudovat do elektrického rozvodu v budově. Musejí být nainstalované v těsné blízkosti přístroje a snadno dostupné pracovníku obsluhy. Je nutno ho označit jako vypínací zařízení přístroje: IEC/EN 61010-1 § 6.11.3.1.
- Přístroj čistěte měkkou utěrkou, nepoužívejte abrazivní produkty, tekutá čistidla či rozpouštědla.



**AVERTIZARE!**

- Citiți cu atenție manualul înainte de instalare sau utilizare.
- Acest echipament va fi instalat de personal calificat. În conformitate cu standardele actuale, pentru a evita deteriorările sau pericolele.
- Înainte de efectuarea oricărei operațiuni de întreținere asupra dispozitivului, îndepărtați toate tensiunile de la intrările de măsurare și de alimentare și scurtcircuitați bornele de intrare CT.
- Producătorul nu poate fi considerat responsabil pentru siguranța electrică în caz de utilizare incorectă a echipamentului.
- Produsele ilustrate în prezentul sunt supuse modificărilor și schimbărilor fără notificare anterioară. Datele tehnice și descrierile din documentație sunt precise, în măsura cunoștințelor noastre, dar nu se acceptă nicio răspundere pentru erorile, omisiunile sau evenimentele neprevăzute care apar ca urmare a acestora.
- Trebuie inclus un disjuncteur în instalația electrică a clădirii. Acesta trebuie instalat aproape de echipament și într-o zonă ușor accesibilă operatorului. Acesta trebuie marcat ca fiind dispozitivul de deconectare al echipamentului: IEC/EN 61010-1 § 6.11.3.1.
- Curățați instrumentul cu un material textil moale și uscat; nu utilizați substanțe abrazive, detergenți lichizi sau solvenți.



**ATTENZIONE!**

- Leggere attentamente il manuale prima dell'utilizzo e l'installazione.
- Questi apparecchi devono essere installati da personale qualificato, nel rispetto delle vigenti normative impiantistiche, allo scopo di evitare danni a persone o cose.
- Prima di qualsiasi intervento sullo strumento, togliere tensione dagli ingressi di misura e di alimentazione e cortocircuitare i trasformatori di corrente.
- Il costruttore non si assume responsabilità in merito alla sicurezza elettrica in caso di utilizzo improprio del dispositivo.
- I prodotti descritti in questo documento sono suscettibili in qualsiasi momento di evoluzioni o di modifiche. Le descrizioni ed i dati a catalogo non possono pertanto avere alcun valore contrattuale.
- Un interruttore o disgiuntore va compreso nell'impianto elettrico dell'edificio. Esso deve trovarsi in stretta vicinanza dell'apparecchio ed essere facilmente raggiungibile da parte dell'operatore. Deve essere marchiato come il dispositivo di interruzione dell'apparecchio: IEC/EN 61010-1 § 6.11.3.1.
- Pulire l'apparecchio con panno morbido, non usare prodotti abrasivi, detergenti liquidi o solventi.



**UWAGA!**

- Przed użyciem i instalacją urządzenia należy uważnie przeczytać niniejszą instrukcję.
- W celu uniknięcia obrażeń osób lub uszkodzenia mienia tego typu urządzenia muszą być instalowane przez wykwalifikowany personel, zgodnie z obowiązującymi przepisami.
- Przed rozpoczęciem jakichkolwiek prac na urządzeniu należy odłączyć napięcie od wejść pomiarowych i zasilania oraz zwrzeć zaciski przekładnika prądowego.
- Producent nie przyjmuje na siebie odpowiedzialności za bezpieczeństwo elektryczne w przypadku niewłaściwego użytkowania urządzenia.
- Produkty opisane w niniejszym dokumencie mogą być w każdej chwili udoskonalone lub zmodyfikowane. Opisy oraz dane katalogowe nie mogą mieć w związku z tym żadnej wartości umownej.
- W instalacji elektrycznej budynku należy uwzględnić przełącznik lub wyłącznik automatyczny. Powinien on znajdować się w bliskim sąsiedztwie urządzenia i być łatwo osiągalny przez operatora. Musi być oznaczony jako urządzenie służące do wyłączania urządzenia: IEC/EN 61010-1 § 6.11.3.1.
- Urządzenie należy czyścić miękką szmatką, nie stosować środków ściernych, płynnych detergentów lub rozpuszczalników.



**警告!**

- 安装或使用前，请仔细阅读本手册。
- 本设备只能由合格人员根据现行标准进行安装，以避免造成损坏或安全危害。
- 对设备进行任何维护操作前，请移除测量输入端和电源输入端的所有电压，并短接 CT 输入端。
- 制造商不负责因设备使用不当导致的电气安全问题。
- 此处说明的产品可能会有变更，恕不提前通知。我们竭力确保本文件中技术数据和说明的准确性，但对于错误、遗漏或由此产生的意外事件概不负责。
- 建筑电气系统中必须装有断路器。断路器必须安装在靠近设备且方便操作人员触及的地方。必须有断路器标记为设备的断开装置：IEC/EN 61010-1 § 6.11.3.1
- 请使用柔软的干布清洁设备；切勿使用研磨剂、洗涤剂或溶剂。



**ПРЕДУПРЕЖДЕНИЕ!**

- Прежде чем приступать к монтажу или эксплуатации устройства, внимательно ознакомьтесь с содержанием настоящего руководства.
- Во избежание травм или материального ущерба монтаж должен осуществляться только квалифицированным персоналом в соответствии с действующими нормативами.
- Перед проведением любых работ по техническому обслуживанию устройства необходимо обеспечить все измерительные и питающие входные контакты, а также замкнуть накоротко входные контакты трансформатора тока (ТТ).
- Производитель не несет ответственность за обеспечение электробезопасности в случае ненадлежащего использования устройства.
- Издания, описанные в настоящем документе, в любой момент могут подвергнуться изменениям или усовершенствованиям. Поэтому каталожные данные и описания не могут рассматриваться как действительные с точки зрения контрактов
- Электрическая сеть здания должна быть оснащена автоматическим выключателем, который должен быть расположен вблизи оборудования в пределах доступа оператора. Автоматический выключатель должен быть промаркирован как отключающее устройство оборудования: IEC/EN 61010-1 § 6.11.3.1.
- Очистку устройства производить с помощью мягкой сухой ткани, без применения абразивных материалов, жидких моющих средств или растворителей.



**DIKKATI!**

- Montaj ve kullanımdan önce bu el kitabını dikkatlice okuyunuz.
- Bu aparatlar kişileri veya nesnelere zarar verme ihtimaline karşı yürürlükte olan sistem kurma normlarına göre kalifiye personel tarafından monte edilmelidir
- Aparata (cihaz) herhangi bir müdahalede bulunmadan önce ölçüm girişlerinde gerekli kesip akım transformatörlerinde kısa devre yaptırınız.
- Üretici aparatın hatalı kullanımından kaynaklanan elektriksel güvenliğe ait sorumluluk kabul etmez.
- Bu dokümanda tarif edilen ürünler her an evrimlere veya değişimlere açıktır. Bu sebeple katalogdaki tarif ve değerler herhangi bir bağlayıcı değeri haiz değildir.
- Binanın elektrik sisteminde bir anahtar veya şalter bulunmalıdır. Bu anahtar veya şalter operatörün kolaylıkla ulaşabileceği yakın bir yerde olmalıdır. Aparatı (cihaz) devreden çıkartma görevi yapan bu anahtar veya şalterin markası: IEC/EN 61010-1 § 6.11.3.1.
- Aparatı (cihaz) sıvı deterjan veya solvent kullanılarak yumuşak bir bez ile siliniz aşındırıcı temizlik ürünleri kullanmayınız.



## CONTENTS

<b>1</b>	<b>General information</b>	6
1.1	Read first then start	6
<b>2</b>	<b>Safety instruction</b>	7
2.1	Basic safety measures	7
2.2	Residual hazards	7
2.3	Application as directed	7
<b>3</b>	<b>Mechanical installation</b>	8
3.1	Dimensions	8
<b>4</b>	<b>Electrical installation</b>	10
4.1	Important notes	10
4.2	Mains connection	10
4.2.1	1-phase mains connection 230/240V	10
4.2.1.1	Connection plan	10
4.2.1.2	Fusing and terminal data	11
4.3	Control connections	11
<b>5</b>	<b>Commissioning</b>	12
5.1	Important notes	12
5.2	Operating interfaces	12
5.2.1	Keypad	12
5.2.2	Software VLBX SW	13
5.2.2.1	Generate a connection between VLA1 and the software VLBX SW	13
5.3	Parameter setting	14
5.3.1	General notes on parameters	14
5.3.2	Basic variable speed drive settings	15
5.3.3	Basic motor settings	17
5.3.4	Function assignment of the inputs and outputs	18
	Frequently used abbreviations in the short keypad designations of the parameters:	20
5.4	Keypad parameter list	20
5.5	Save parameter settings in the memory	20
5.5.1	Save parameter settings with keypad	20
<b>6</b>	<b>Diagnostics and fault elimination</b>	21
6.1	LED status display	21
6.2.1	Logbook	22
6.2	Diagnostics parameter	22
6.2.2	Error history buffer	23
6.2.3	Variable speed drive diagnostics	24
6.2.5	Diagnostics of the inputs and outputs	26
6.2.5.1	Digital inputs and outputs	26
6.2.5.2	Analog inputs and outputs	27
6.2.8	Process controller status	28
6.2.9	Sequencer diagnostic	28
6.2.10	Device identification	29
6.2.11	Device overload monitoring (i*t)	30
6.2.12	Heatsink Temperature Monitoring	30
6.2.13	Life-diagnosis	30
6.3.2	Error configuration	31
6.3.3	Error reset	31
6.3.4	Keypad error messages	31
6.3	Error handling	31
6.3.1	Error types	31
6.4	Data handling	32

<b>7</b>	<b>Basic setting</b>	33
7.1	Mains voltage	33
7.2	Control source selection	34
7.3	Selection of setpoint source	35
7.3.1	Keypad setpoint default settings	37
7.4	Starting/stopping performance	38
7.4.1	Starting performance	38
7.4.2	Stopping performance	40
7.5	Frequency limits and ramp time	41
7.6	Quick stop	43
7.8	Optical device identification	44
<b>8</b>	<b>Motor control</b>	45
8.1	Motor data 46	
8.1.1	Manual setting of the motor data	46
8.2	Motor control selection	47
8.2.1	V/f characteristic control (VFC)	47
8.2.1.1	Linear V/f characteristic	48
8.2.1.2	Square-law V/f characteristic	48
8.2.2	Sensorless vector control (SLVC)	49
8.3	Optimisation of motor control	50
8.3.1	V/f voltage boost	50
8.3.2	Skip frequencies	51
8.3.3	Optimising the stalling behaviour	53
8.3.4	Slip compensation	54
8.3.5	Oscillation damping	55
8.4	Optimisation of the control loops	56
8.4.1	Option for optimized motor tuning	56
8.4.1.1	Tuning of the motor and the speed controller	56
8.4.1.2	Automatic motor identification (energized)	57
8.4.1.3	Automatic motor calibration (non-energized)	57
8.4.2	Inverter Characteristics	57
8.4.3	Motor equivalent circuit diagram data	58
8.4.4	Motor controller settings	58
8.4.4.1	Current controller	58
8.4.4.2	Field controller	59
8.4.4.3	Field weakening controller	59
8.4.4.4	Field weakening controller (advanced)	59
8.4.4.5	Imax controller	60
8.4.4.6	Flying restart controller	60
8.4.4.7	SLVC controller	60
8.4.4.8	Torque control w/ freq. limit	61
8.4.5	Speed controller	64
8.5	Motor rotating direction	65
8.6	Switching frequency changeover	66
8.7	Motor protection	67
8.7.1	Motor overload monitoring ( $i^2 \cdot t$ )	67
8.7.2	Current limits	69
8.7.3	Overcurrent monitoring	70
8.7.4	Motor phase failure detection	70
8.7.5	Motor speed monitoring	71
8.7.6	Motor torque monitoring	71
<b>9</b>	<b>Configuring the process controller</b>	72
9.1	Basic process controller settings	72
9.2	Process controller - idle state and rinse function	76
9.2.1	Process controller idle state	76
9.2.2	Process controller rinse function	77

<b>10</b>	<b>Additional functions</b>	78
10.1	Device Commands	78
10.1.1	Reset parameters to default	78
10.1.2	Saving/loading the parameter settings	78
10.1.3	Device commands for parameter change-over	80
10.1.4	Delete logbook	80
10.2	Keypad	80
10.2.1	Keypad language selection	80
10.2.3	Keypad scaling of speed display	80
10.2.4	Keypad status display	81
10.2.5	Keypad - Configuration of R/F and CTRL button Keypad rotation setup	81
10.4	DC braking	82
10.4.1	Example 1: Automatic DC braking when the motor is started	84
10.4.2	Example 2: Automatic DC braking when the motor is stopped	85
10.5	Brake energy management	86
10.5.1	Stopping the deceleration ramp function generator	87
10.5.2	Inverter motor brake	88
10.6	Load loss detection88	
10.8	Favorites 89	
10.8.1	Accessing the "Favorites" with the keypad	89
10.8.2	Favorites parameter list (default setting)	90
10.8.3	Configuring the "Favorites"	91
10.9	Parameter change-over	93
10.9.1	Example: Selective control of several motors with one variable speed drive	95
10.11	Holding brake control	95
10.11.1	Basic setting	96
10.11.2	"Automatic" brake mode (automatic operation)	96
10.11.3	Brake holding load	97
10.11.4	Brake closing level	99
10.11.5	Manual release of the holding brake	100
10.12	Flying restart circuit	100
10.13	Timeout fault reaction	101
10.14	Automatic restart 101	
10.18	Firmware download	102
10.18.1	Firmware download with software VLBX SW 02 (Firmware loader)	102
<b>11</b>	<b>Sequencer</b>	103
11.1	Segment configuration	104
11.2	Sequence configuration	110
11.3	Sequencer basic settings	113
<b>12</b>	<b>Flexible I/O configuration</b>	115
12.1	Control source change-over	115
12.1.1	Example 1: Change-over from terminal control to keypad control	117
12.2	Start / stop motor	118
12.2.1	Example 1: Start/stop (1 signal) and reversal	121
12.2.4	Example 2: Quick stop	122
12.2.5	Example 3: Jog forward/Jog reverse	123
12.2.6	Example 4: Enable inverter	124
12.3	Setpoint change-over	125
12.3.1	Priority of the setpoint sources	126
12.3.2	Analog input setpoint source	126
12.3.3	Keypad setpoint source	129
12.3.5	Setpoint source of preset setpoints	131
12.3.6	Motor potentiometer setpoint source (MOP)	135
12.3.7	Setpoint source segment setpoints	138
12.4	Reset error139	
12.5	Activating DC braking manually	141
12.6	Releasing holding brake manually	142
12.7	Activating ramp 2 manually	144

12.9	Function for parameter change-over	146
12.9.1	Example 1: Activation via command (only when disabled)	147
12.9.2	Example 2: Activation via command (immediately)	148
12.9.3	Example 3: Activation if the selection is changed (only if the variable speed drive is disabled)	149
12.9.4	Example 4: Activation if the selection is changed (immediately)	150
12.10	Process controller function selection	151
12.11	Sequencer control function	153
12.12	Frequency threshold for "Frequency threshold exceeded" trigger	157
12.13	Configuration of digital inputs	158
12.14	Configuration of analog inputs	159
12.14.1	Analog input 1	159
12.14.1.1	Example 1: Input range 0 ... 10 V setting range 0 ... 50 Hz	161
12.14.1.2	Example 2: Input range 0 ... 10 V setting range -40 ... +40 Hz	161
12.14.1.3	Example 3: Error detection	162
12.14.2	Analog input 2 Settings for analog input 2. Details	163
12.15	Configuration of digital outputs	164
12.15.1	Relay	164
12.15.2	Digital output 1	166
12.16	Configuration of analog outputs	167
12.16.1	Analog output 1	167
12.16.1.1	Example 1: Output voltage 0 ... 10 V output frequency 0 ... 100 Hz	168
12.16.1.2	Example 2: Output voltage 2 ... 10 V output frequency 30 ... 60 Hz	168
<b>13</b>	<b>Technical data</b>	<b>169</b>
13.1	Standards and operating conditions	169
13.1.1	Protection of persons and device protection	169
13.1.2	EMC data	169
13.1.3	Motor connection	169
13.1.4	Environmental conditions	170
13.1.5	Electrical supply conditions	170
13.2	1-phase mains connection 230/240 V	170
13.2.1	Rated data	170
<b>14</b>	<b>Appendix</b>	<b>171</b>
14.1	Operate and parameterise the variable speed drive with keypad	171
14.1.1	Keypad operating mode	171
14.1.1.1	Keypad status display	171
14.1.1.2	Function of keypad keys in operating mode	172
14.1.1.3	Error reset with keypad	172
14.1.2	Keypad parameterisation mode	173
14.1.2.1	Parameter groups	173
14.1.2.2	Function of the keypad keys in the parameterisation mode	173
14.1.2.3	Save parameter settings with keypad	174
14.1.2.4	Display of status words on keypad	175
14.2	Error codes	175

---

## 1 GENERAL INFORMATION

### 1.1 READ FIRST THEN START



#### WARNING!

Read this documentation thoroughly before carrying out the installation and commissioning.

- ▶ Please observe the safety instructions.

## 2 SAFETY INSTRUCTION

### 2.1 BASIC SAFETY MEASURES

Disregarding the following basic safety measures may lead to severe personal injury and damage to material assets!

The product

- must only be used as directed.
- must never be commissioned if they display signs of damage.
- must never be technically modified
- must never be commissioned if they are not fully mounted.
- must never be operated without required covers.

Connect/disconnect all pluggable terminals only in deenergised condition Only remove the product from the installation in the deenergised state.

Insulation resistance tests between 24V control potential and PE: According to EN 61800-5-1, the maximum test voltage must not exceed 110VDC.

Observe all specification of the corresponding documentation supplied. This is the precondition for safe and trouble-free operation and for obtaining the product features specified.

The procedural notes and circuit details described in this document are only proposals. It is up to the user to check whether they can be adapted to the particular applications. LOVATO Electric does not take any responsibility for the suitability of the procedures and circuit proposals described.

The product must only be used by qualified personnel. IEC 60364 or GENELEC HD 384 define the skills of these persons:

- They are familiar with installing, mounting commissioning, and operating the product.
- They have the corresponding qualifications for their work.
- They know and can apply all regulation for the prevention of accidents, directives and laws applicable at the place of use.

Please observe the specific notes in the other chapters!

Notes used:

 **DANGER!**

This note refers to an imminent danger which, if not avoided, may result in death or serious injury.

 **WARNING!**

This note refers to a danger which, if not avoided, may result in death or serious injury.

 **CAUTION!**

This note refers to a danger which, if not avoided, may result in minor or moderate injury.

**NOTICE**

This note refers to a danger which, if not avoided, may result in damage to property.





### 2.2 RESIDUAL HAZARDS

The user must take the residual hazards mentioned into consideration in the risk assessment for his/her machine/system.

If the above is disregarded, this can lead to severe injuries to persons and damage to material assets!

#### PRODUCT

Observe the warning labels on the product!

ICON	DESCRIPTION
	<b>Electrostatic sensitive devices</b> Before working on the product, the staff must ensure to be free of electrostatic charge!
	<b>Dangerous electrical voltage</b> Before working on the product, check if no voltage is applied to the power terminals! After mains disconnection the power terminals carry the hazardous electrical voltage given on the product!
	<b>High leakage current</b> Carry out fixed installation and PE connection in compliance with EN 61800-5-1 or EN 60204-1!
	<b>Hot surface</b> Use personal protective equipment or wait until devices have cooled down!

#### MOTOR

If there is a short circuit of two power transistors, a residual movement of up to 180°/number of pole pairs can occur at the motor! (For 4-pole motor: residual movement max.  $180^\circ/2 = 90^\circ$ ).

### 2.3 APPLICATION AS DIRECTED

– The product must only be operated under the operating conditions prescribed in this documentation.

- The product meets the protection requirements of 2014/35/EU: Low-Voltage Directive
- The product is not a machine in terms of 2006/42/EC: Machinery Directive
- Commissioning or starting the operation as directed of a machine with the product is not permitted until it has been ensured that the machine meets the regulation of the EC Directive 2006/42/EC: Machinery Directive observe EN 60204-1.
- Commissioning or starting the operation as directed is only allowed when there is compliance with the EMC Directive 2014/30/EU.
- The harmonised standard EN 61800-5-1 is used for the variable speed drives.
- The product is not a household appliance, but is only designed as component for commercial or professional use in terms of EN 61000-3-2.
- The product can be used according to the technical data if drive systems have to comply with categories according to EN 61800-3.  
In residential areas, the product may cause EMC interferences. The operator is responsible for taking interference suppression measures.

**3 MECHANICAL INSTALLATION**  
**3.1 DIMENSIONS**

VLA1 02 A240 – VLA1 04 A240

1585 GB 09 18

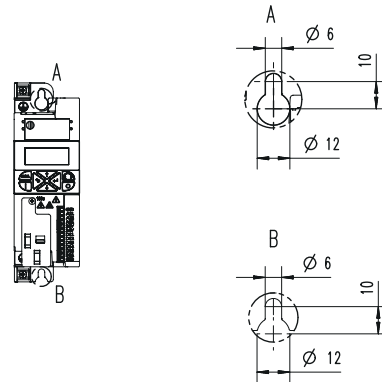
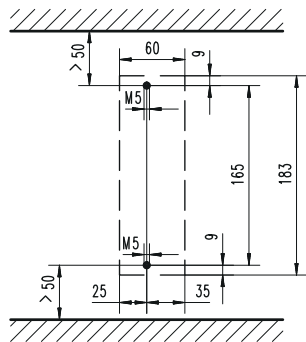
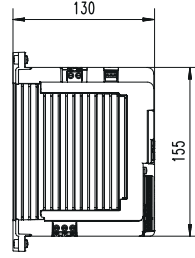
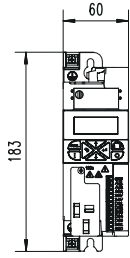

VLA1 07 A240

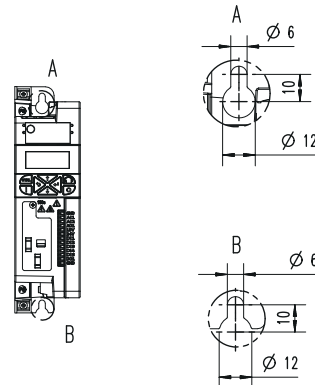
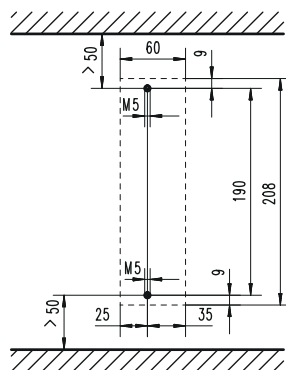
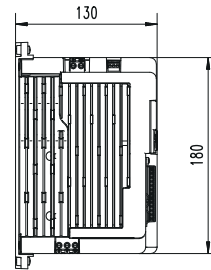
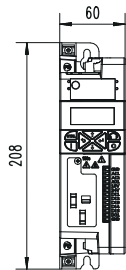

All dimensions in mm



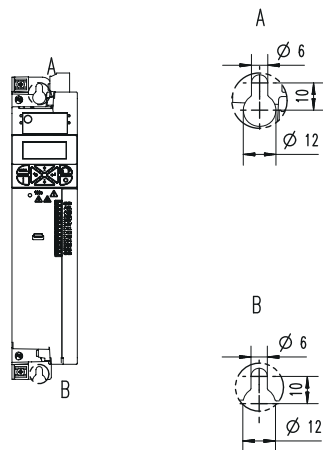
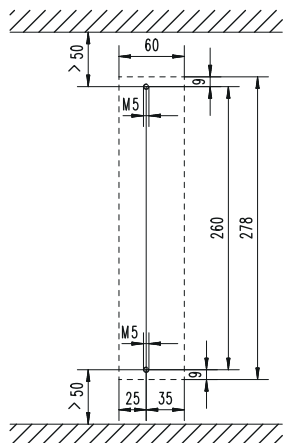
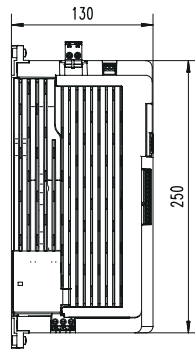
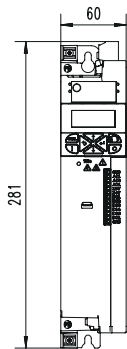

All dimensions in mm

## 4 ELECTRICAL INSTALLATION

### 4.1 IMPORTANT NOTES

#### ⚠ DANGER!

Dangerous electrical voltage

Possible consequence: death or severe injuries

- ▶ All work on the variable speed drives must only be carried out in the deenergised state.
- ▶ After switching off the mains voltage, wait for at least 3 minutes before you start working.

1585 GB 09 18

### 4.2 MAINS CONNECTION

#### 4.2.1 1-PHASE MAINS CONNECTION 230/240V

##### 4.2.1.1 CONNECTION PLAN

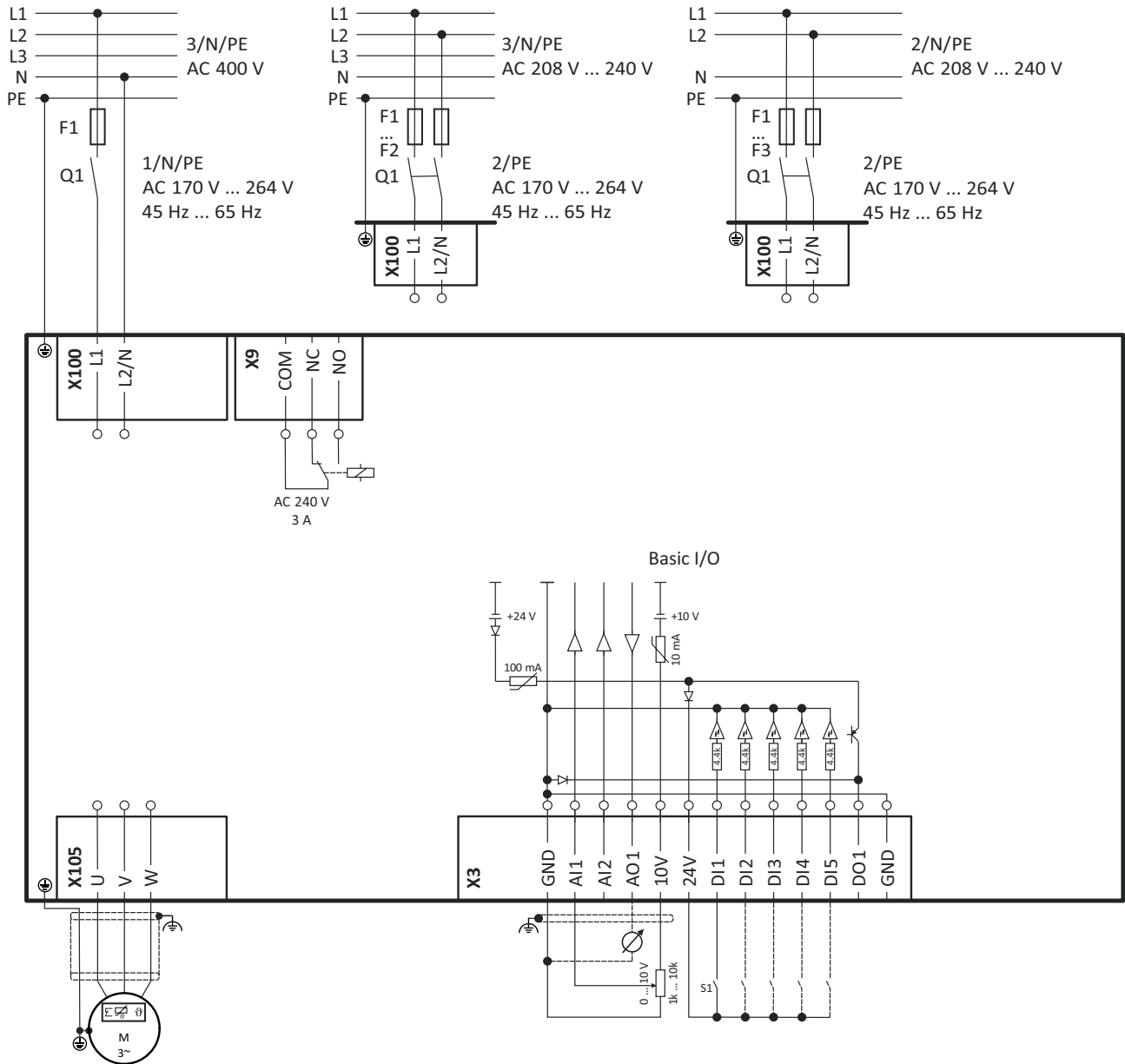

Fig. 1: Wiring example

S1 Start/Stop  
Fx Fuses

Q1 Mains contactor  
--- Dashed line = options

#### 4.2.1.2 FUSING AND TERMINAL DATA

Power	kW	0.25	0.4	0.75	1.5	2.2
Cable installation in compliance with		EN 60204-1				
Laying system		B2				
Operation		without mains choke				
Fuse						
Characteristic		gG/gL or gRL				
Max. rated current	A	10	10	16	25	25
Circuit breaker						
Characteristic		B				
Max. rated current	A	10	10	16	25	25
Operation		with mains choke				
Fuse						
Characteristic		gG/gL or gRL				
Max. rated current	A	10	10	16	25	25
Circuit breaker						
Characteristic		B				
Max. rated current	A	10	10	16	25	25
Earth-leakage circuit breaker		≥ 30 mA, type A or B				
Mains connection						
Connection		X100				
Connection type		Screw terminal				
Min. cable cross-section	mm <sup>2</sup>	1				
Max. cable cross-section	mm <sup>2</sup>	2.5		6		
Stripping length	mm	8				
Tightening torque	Nm	0.5			0.7	
Required tool		0.5 x 3.0			0.6 x 3.5	
Motor connection						
Connection		X105				
Connection type		Screw terminal				
Min. cable cross-section	mm <sup>2</sup>	1				
Max. cable cross-section	mm <sup>2</sup>	2.5				
Stripping length	mm	8				
Tightening torque	Nm	0.5				
Required tool		0.5 x 3.0				
PE connection						
Connection		PE				
Connection type		PE screw				
Min. cable cross-section	mm <sup>2</sup>	1				
Max. cable cross-section	mm <sup>2</sup>	6				
Stripping length	mm	10				
Tightening torque	Nm	1.2				
Required tool		0.8 x 5.5				

#### 4.3 CONTROL CONNECTIONS

Terminal description		Relay output	Control terminals
Connection		X9	X3
Connection type		pluggable screw terminal	Spring terminal
Min. cable cross-section	mm <sup>2</sup>	0.5	0.5
Max. cable cross-section	mm <sup>2</sup>	1.5	1.5
Stripping length	mm	6	9
Tightening torque	Nm	0.2	-
Required tool		0.4 x 2.5	0.4 x 2.5

## 5 COMMISSIONING

### 5.1 IMPORTANT NOTES

#### WARNING!

Incorrect wiring can cause unexpected states during the commissioning phase. Possible consequence: death, severe injuries or damage to property  
Check the following before switching on the mains voltage:

- Is the wiring complete and correct?
- Are there no short circuits and earth faults?
- Is the motor circuit configuration (star/delta) adapted to the output voltage of the variable speed drives?
- Is the motor connected in-phase (direction of rotation)
- Does the "emergency stop" function of the entire plant operate correctly?

#### WARNING!

Incorrect settings during commissioning may cause unexpected and dangerous motor and system movements.  
Possible consequence: death, severe injuries or damage to property

- Clear hazardous area.
- Observe safety instructions and safety clearances.

### 5.2 OPERATING INTERFACES

Commissioning the variable speed drive requires an operator-process interface.

#### 5.2.1 KEYPAD

The keypad is an easy means for the local operation, parameterisation, and diagnostics of the variable speed drive.



- The keypad is simply connected to the diagnostic interface on the front of the variable speed drive.
- The keypad can also be connected and removed during operation

Detailed information on the keypad can be found in the appendix:

- Operate and parameterise the variable speed drive with keypad

### 5.2.2 SOFTWARE VLBX SW

The VLBX SW is a PC software that is especially designed for the commissioning and maintenance of the variable speed drives VLA1 and VLB3 series.

**i** The VLBX SW software can be downloaded from Lovato Electric website: [www.LovatoElectric.com](http://www.LovatoElectric.com) > Downloads > Software & Upgrades > Variable speed drives

Sample screenshot:

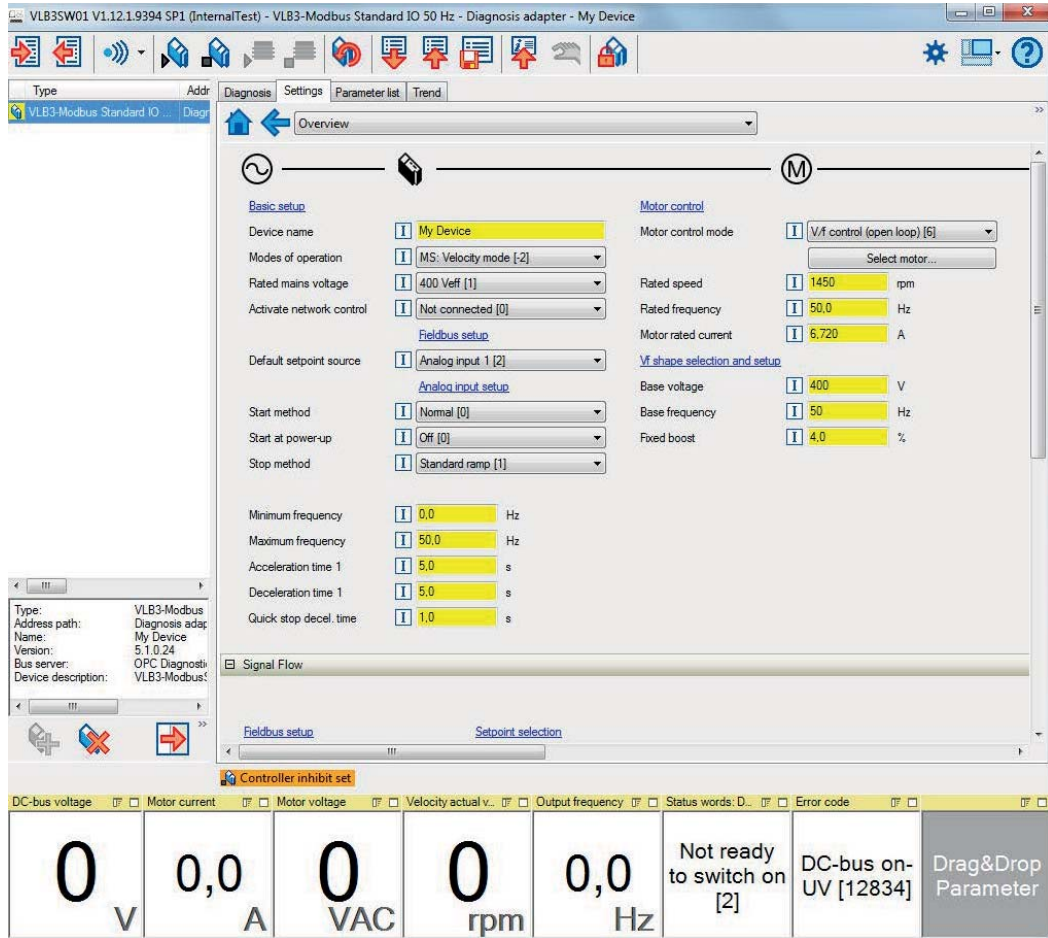

#### 5.2.2.1 GENERATE A CONNECTION BETWEEN VLA1 AND THE SOFTWARE VLBX SW

For commissioning the VLA1 variable speed drive with the software VLBX SW is necessary to use the USB module VLAX C02 (to be purchased separately) and a USB 2.0 cable (A plug on Micro-B plug).



For details about the connection and the use of VLBX SW software, refer to the technical manual of the VLBX SW software.

### 5.3 PARAMETER SETTING

As a part of a machine with a speed-variable drive system, the variable speed drive must be adapted to its drive task. The adaptation process of the variable speed drive is carried out by changing parameters. Optionally these parameters can be accessed by means of the keypad or software VLBX SW.

**i** Certain device commands or settings which might cause a critical state of the drive behaviour can only be carried out when the variable speed drive is inhibited.

#### 5.3.1 GENERAL NOTES ON PARAMETERS

Each parameter features a 16-bit index as address. Under this address, the parameter is stored in the object directory of the variable speed drive.

- Parameters that belong together functionally are combined in a data set. These parameters are additionally provided with an 8-bit subindex.
- The colon is used as a separator between the index and subindex Example: "0x2540:001"
- There are parameters the setting of which can be changed, and (diagnostic parameters which can only be read.

#### Parameterisation using the keypad

- All parameters which can be accessed by means of the keypad are provided with a "Display code", the first digit of the display code specifying the group in which the parameter can be found on the keypad.
- In the documentation the display code — if available — is specified in brackets behind the address. Example: "0x2915 (P210.00)".
- ▶ Keypad parameterisation mode

#### Structure of the parameter descriptions in this documentation

- The parameter descriptions in this documentation are structured in table form.
- The representation distinguishes parameters with a setting range, text, selection list, and bit-coded display.
- The default setting of parameters with a write access feature is shown in bold.
- The display code as well as the short keypad designation of the parameter which is limited to 16 characters, are — if available — shown in brackets.

#### Example: parameters with a setting range

Parameter	Name / value range / [default setting]	Info
Index:Subindex (display code)	Parameter designation (abbreviated keypad designation) Minimum value ... [default setting ] ... maximum value – Optional information with regard to the parameter.	Explanations & notes with regard to the parameter.

#### Example: parameters with a selection list

Parameter	Name / value range / [default setting]	Info
Index:Subindex (display code)	Parameter designation (abbreviated keypad designation) – Optional information with regard to the parameter.	Explanations & notes with regard to the parameter. Note: The corresponding selection number (here 0, 1, or 2) must be set. Other values are not permissible.
	<b>0</b> Designation of selection 0	Optionally: Explanations & notes with regard to the corresponding selection
	1 Designation of selection 1	The default selection is shown in <b>bold</b> .
	2 Designation of selection 2	

#### Example: parameters with a bit-coded display

Parameter	Name / value range / [default setting]	Info
Index:Subindex (display code)	Parameter designation (abbreviated keypad designation) – Optional information with regard to the parameter.	Explanations & notes with regard to the parameter.
	Bit 0 Designation of bit 0	Optionally: Explanations & notes with regard to the corresponding bit.
	Bit 1 Designation of bit 1	
	Bit 2 Designation of bit 2	
	... ..	
	Bit 15 Designation of bit 15	

### 5.3.2 BASIC VARIABLE SPEED DRIVE SETTINGS

Check the following basic settings of the variable speed drive and adapt them, if required.

Parameter	Name / value range / [default setting]	Info
0x2540:001 (P208.01)	Mains settings: Rated mains voltage (Mains settings: Mains voltage) – Setting can only be changed if the variable speed drive is inhibited.	Selection of the mains voltage for actuating the variable speed drive.
	<b>0</b> 230 Veff	
	1 400 Veff	
	2 480 Veff	
	3 120 Veff	
0x2838:001 (P203.01)	Start/stop configuration: Start method (Start/stop config: Start method) – Setting can only be changed if the variable speed drive is inhibited.	Behaviour after start command.
	<b>0</b> Normal	After start command, the standard ramps are active – Acceleration time 1 can be set in 0x2917 (P220.00). – Deceleration time 1 can be set in 0x2918 (P221.00).
	1 DC braking	After start command, the "DC braking" function is active for the time set in 0x2B84:002 (P704.02). ► For details see chapter "DC braking"
	2 Flying restart circuit	After the start command, the flying restart circuit is active The flying restart function makes it possible to restart a coasting motor during operation without speed feedback. Synchronicity between the inverter and motor is coordinated so that the transition to the rotating motor is effected without jerk at the time of connection ► For details see chapter "Flying restart circuit"
	3 For future use	
0x2838:002 (P203.02)	Start/stop configuration: Start at power-up (Start/stop config: Start at powerup)	Behaviour after the "Stop" command.
	0 Coasting	The motor becomes torqueless (coasts down to standstill)
	<b>1</b> Standard ramp	The motor is brought to a standstill with deceleration time 1 (or deceleration time 2, if activated) – Deceleration time 1 can be set in 0x2918 (P221.00). – Deceleration time 2 can be set in 0x291A (P223.00). ► For details see chapter "frequency limits and ramp times"
	2 Quick stop ramp	The motor is brought to a standstill with the deceleration time set for the "Quick stop" function – Deceleration time for quick stop can be set in 0x291C (P225.00). – The "quick stop" function can also be activated manually, for instance via a digital input. ► For details see chapter "Quick stop"
0x283A (P304.00)	Limitation of rotation (Limit. rotation)	Optional restriction of the rotating direction
	0 Only clockwise (CW)	The motor can only be rotated clockwise (CW). The transfer of negative frequency and PID setpoints to the motor control is prevented. – This function takes effect after the "Reverse rotational direction" function (0x2631:013 (P400.13)). – Since this function only prevents negative setpoints, counter-clockwise rotation (CCW) is possible if the motor has been wired for this rotating direction.
	<b>1</b> Both rotational directions	Both directions of motor rotation are enabled.

1585 GB 09 18

Parameter	Name / value range / [default setting]	Info			
0x2860:001 (P201.01)	Frequency control: Default setpoint source (Std. setpoints: Freq. setp. src.)	Selection of the standard setpoint source for operating mode "MS: Velocity mode". – The selected standard setpoint source is always active in the operating mode 0x6060 (P301.00) = "MS: Velocity mode [-2]" when no setpoint change-over to another setpoint source via corresponding triggers/function is active ► For details see chapter "Setpoint change-over"			
	1 Keypad	The setpoint is specified locally by the keypad. – Default setting: 0x2601:001 (P202.01) – Use the <b>↑</b> and <b>↓</b> navigation keys to change the keypad setpoint (also during running operation)			
	2 Analog input 1	The setpoint is defined as analog signal via the analog input 1. ► For details see chapter "Analog input 1"			
	3 Analog input 2	The setpoint is defined as analog signal via the analog input 2. ► For details see chapter "Analog input 2"			
	5 Network	The setpoint is defined as process data object via the network. (Not available for standard VLA1 variable speed drives)			
	11 Frequency preset 1	For the setpoint selection, preset values can be parameterised and selected. ► For details see chapter "Setpoint source of preset setpoints"			
	12 Frequency preset 2				
	13 Frequency preset 3				
	14 Frequency preset 4				
	15 Frequency preset 5				
	16 Frequency preset 6				
	17 Frequency preset 7				
	18 Frequency preset 8				
	19 Frequency preset 9				
	20 Frequency preset 10				
	21 Frequency preset 11				
	22 Frequency preset 12				
	23 Frequency preset 13				
	24 Frequency preset 14				
	25 Frequency preset 15				
	31 Segment preset 1	31 Segment preset 1 32 Segment preset 2 33 Segment preset 3 34 Segment preset 4 35 Segment preset 5 36 Segment preset 6 37 Segment preset 7 38 Segment preset 8	For the setpoint selection, the segment presets parameterised for the "sequencer" function can be selected as well. ► For details see chapter "Sequencer"		
				50 Motor potentiometer	The setpoint is generated by the "motor potentiometer" function This function can be used as an alternative setpoint control which is controlled via two signals: "MOP setpoint up" and "MOP setpoint down". ► For details see chapter "Motor potentiometer setpoint source (MOP)"
				201 Internal value	Internal values of the manufacturer.
				202 Internal value	
				203 Internal value	
204 Internal value					
205 Internal value					
206 Internal value					
0x2911:001 (P450.01)		Frequency setpoint presets: Preset 1 (Freq. presets: Freq. preset 1) 0.0 ... [20.0] ... 599.0 Hz			
0x2911:002 (P450.02)		Frequency setpoint presets: Preset 2 (Freq. presets: Freq. preset 2) 0.0 ... [40.0] ... 599.0 Hz			
0x2911:003 (P450.03)		Frequency setpoint presets: Preset 3 (Freq. presets: Freq. preset 3) Device for 50-Hz mains: 0.0 ... [50.0] ... 599.0 Hz Device for 60-Hz mains: 0.0 ... [60.0] ... 599.0 Hz			
0x2915 (P210.00)	Minimum frequency (Min. frequency) 0.0 ... [0.0] ... 599.0 Hz	Lower limit value for all frequency setpoints.			
0x2916 (P211.00)	Maximum frequency (Max. frequency) Device for 50-Hz mains: 0.0 ... [50.0] ... 599.0 Hz Device for 60-Hz mains: 0.0 ... [60.0] ... 599.0 Hz	Upper limit value for all frequency setpoints.			
0x2917 (P220.00)	Acceleration time 1 (Accelerat.tim 1) 0.0 ... [5.0] ... 3600.0 s	Acceleration time 1 for the operating mode "MS: Velocity mode". – The acceleration time set refers to the acceleration from standstill the maximum frequency set. In the case of a lower setpoint selection the actual acceleration time is reduced accordingly.			
0x2918 (P221.00)	Deceleration time 1 (Decelerat.time 1) 0.0 ... [5.0] ... 3600.0 s	Deceleration time 1 for the operating mode "MS: Velocity mode". – The deceleration time set refers to the deceleration from the maximum frequency set to standstill. In the case of a lower actual frequency, the actual deceleration time is reduced accordingly.			
0x291C (P225.00)	Quick stop deceleration time (QSP dec. time) 0.0 ... [1.0] ... 3600.0 s	Quick stop deceleration time for the operating mode "MS: Velocity mode". – If the "Quick stop" function is activated the motor is brought to a standstill within the deceleration time set here. – If the "Quick stop" function is activated the motor is brought to a standstill within the deceleration time set here. – The deceleration time set refers to the deceleration from the maximum frequency set to standstill. In the case of a lower actual frequency, the actual deceleration time is reduced accordingly.			

All possible basic settings are described in the "Basic setting" chapter.



### 5.3.3 BASIC MOTOR SETTINGS

Check the following default settings for the motor and motor control and adapt them, if required.

#### Drive behaviour by default

By default, the V/f characteristic control with a linear characteristic is preset as motor control for asynchronous motors. The V/f characteristic control is a motor control for conventional frequency drive applications. It is based on a simple and robust control mode for the operation of asynchronous motors with a linear or square-law load torque characteristic (e.g. fan). Because of the minimal parameterisation effort, such applications can be commissioned easily and quickly.

The default settings of the parameters ensure that the variable speed drive is ready for operation immediately and the motor works adequately without further parameterisation if a variable speed drive and an asynchronous motor\* Hz asynchronous machine with matching performances are assigned to each other.

\* Depending on the device/mains frequency either 50-Hz asynchronous motor or 60-Hz asynchronous motor.

1585 GB 09 18

Parameter	Name / value range / [default setting]	Info
0x2B01:001 (P303.01)	V/f shape data: Base voltage (V/f shape data: Base voltage) 0 ... [230]* ... 5000V *Default setting depending on the size.	Base voltage and base frequency define the V/f ratio and thus the gradient of the V/f characteristic – The V/f base voltage is usually set to the rated motor voltage 0x2C01:007 (P320.07). – The V/f base frequency is usually set to the rated motor frequency 0x2C01:005 (P320.05).
0x2B01:002 (P303.02)	V/f shape data: Base frequency (V/f shape data: Base frequency) Device for 50-Hz mains: 0 ... [50]* ... 1500 Hz Device for 60-Hz mains: 0 ... [60]* ... 1500 Hz *Default setting depending on the size.	
0x2C00 (P300.00)	Motor control mode (Motor ctrl mode) – Setting can only be changed if the variable speed drive is inhibited.	Selection of the motor control type.
	4   Sensorless vector control (SLVC)	This control type is used for sensorless vector control of an asynchronous motor. ► For details see chapter "Sensorless vector control (SLVC)"
	6   <b>V/f characteristic control (VFC open loop)</b>	This control mode is used for the speed control of an asynchronous motor via a V/f characteristic and is the simplest control mode. ► For details see chapter "V/f characteristic control (VFC)"
0x6075 (P323.00)	Motor rated current (Motor current) 0.001 ... [1.700]* ... 500.000 A *Default setting depending on the size. – Setting can only be changed if the inverter is inhibited.	The rated motor current to be set here serves as a reference value for different parameters with a setting/display of a current value in percent. Example: – Motor rated current = 1.7 A – Max current 0x6073 (P324.00) = 200 % Motor rated current = 3.4 A

All possible settings with regard to the motor and motor control are described in the "Motor control" chapter.

### 5.3.4 FUNCTION ASSIGNMENT OF THE INPUTS AND OUTPUTS

The variable speed drive control can be adapted individually to the respective application. This is basically effected by assigning digital control sources ("triggers") to functions of the variable speed drive.

By default, the variable speed drive can be controlled via the I/O terminals as follows:

1585 GB 09 18

#### Input signals

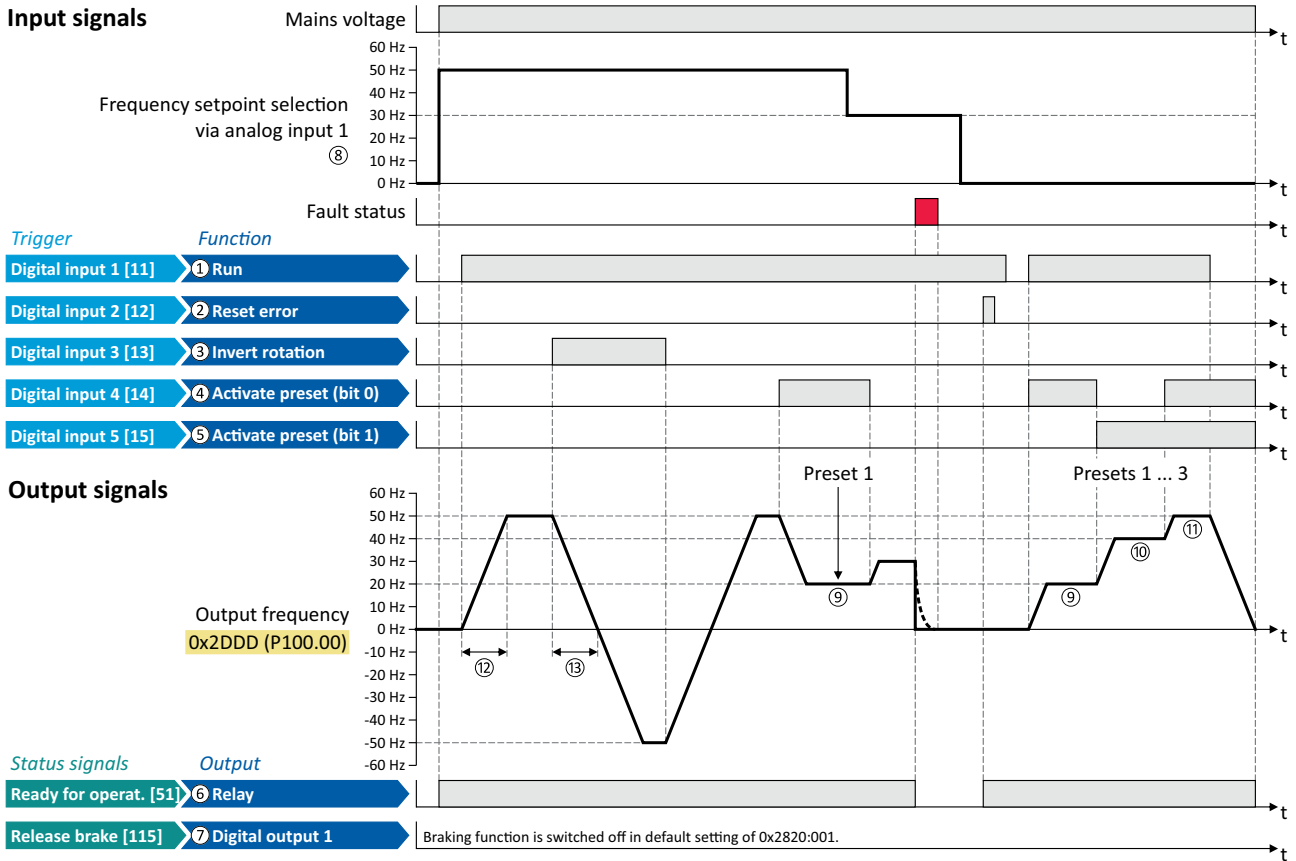

Parameter	Name	Default setting
<b>Control function</b>		
①	0x2631:002 (P400.02)	Run
②	0x2631:004 (P400.04)	Reset fault
③	0x2631:013 (P400.13)	Reverse rotational direction
④	0x2631:018 (P400.18)	Activate preset (bit 0)
⑤	0x2631:019 (P400.19)	Activate preset (bit 1)
<b>Configuration of digital outputs</b>		
⑥	0x2634:001 (P420.01)	Relay
⑦	0x2634:002 (P420.02)	Digital output 1
<b>Settin for the frequency setpoint</b>		
⑧	0x2860:001 (P201.01)	Frequency control: Default setpoint source
⑨	0x2911:001 (P450.01)	Frequency setpoint presets: Preset 1
⑩	0x2911:002 (P450.02)	Frequency setpoint presets: Preset 2
⑪	0x2911:003 (P450.03)	Frequency setpoint presets: Preset 3
⑫	0x2917 (P220.00)	Acceleration time 1
⑬	0x2918 (P221.00)	Deceleration time 1

Parameter	Name / value range / [default setting]	Info
0x2631:002 (P400.02)	Function list: Run (Function list: Run) – Setting can only be changed if the inverter is inhibited. – For further possible settings see parameter 0x2631:001 (P400.01).	Assignment of a trigger for the "Run" function  <b>Function 1: Start / stop motor (default setting)</b> Function 1 is active if no further start commands have been connected to triggers, no keypad control is active. Trigger = TRUE: Let motor rotate forward (CW). Trigger = FALSE: Stop motor.  Notes to function 1: – If "Enable inverter" 0x2631:001 (P400.01) is set = "Constant TRUE [1]", the only permissible trigger for this function is a digital input in order that the motor can be stopped again any time – The stop method can be selected in 0x2838:003 (P203.03). – The function also serves to realise an automati start after switch-on. ► For details see chapter "Starting performance"
	<b>11</b> Digital input 1	<b>Function 2: Start enable/stop motor</b> Function 2 is active if further start commands have been connected to triggers, keypad control is active. Trigger = TRUE: Start commands of the active control source are enabled. Trigger = FALSE: Stop motor.  Notes to function 2: – If no separate start enable is required for the application, the trigger "Constant TRUE [1]" must be set. – The stop method can be selected in 0x2838:003 (P203.03). Assignment of a trigger for the "Run" function. Trigger = FALSE-TRUE edge: Drive is started in forward rotatin directio (CW) if the following condition are fulfilled – Controller is enabled and no error or quick stop are active – No other start command is configure (start-forwards/start-back- wards/run-forwards/run-backwards = "Not connected [0]"). Trigger = TRUE-FALSE edge: drive is stopped again.
0x2631:004 (P400.04)	Function list: Reset fault (Function list: Reset fault) – For further possible settings see parameter 0x2631:001 (P400.01).	Assignment of a trigger for the "Reset fault" function Trigger = FALSE>TRUE (edge): Active error is reset (acknowledged) if the error condition is not active anymore and the error is resettable. Trigger = FALSE: no action
	<b>12</b> Digital input 2	
0x2631:013 (P400.13)	Function list: Reverse rotational direction (Function list: Reverse rot.dir.) – Setting can only be changed if the variable speed drive is inhibited. – For further possible settings see parameter 0x2631:001 (P400.01).	Assignment of a trigger for the "Reverse rotational direction function Trigger = TRUE: the setpoint specified is inverted (i. e. the sign is inverted). Trigger = FALSE: no action / deactivate function again.
	<b>13</b> Digital input 3	
0x2631:018 (P400.18)	Function list: Activate preset (bit 0) (Function list: Setp: Preset b0) – For further possible settings see parameter 0x2631:001 (P400.01).	Assignment of a trigger for the "Activate preset (bit 0)" function Selection bit with the valency 20 for thebit-coded selection and activation of a parameterised setpoint (preset value). Trigger = FALSE: selection bit = "0". Trigger = TRUE: selection bit = "1".
	<b>14</b> Digital input 4	
0x2631:019 (P400.19)	Function list: Activate preset (bit 1) (Function list: Setp: Preset b1) – For further possible settings see parameter 0x2631:001 (P400.01).	Assignment of a trigger for the "Activate preset (bit 1)" function Selection bit with the valency 21 for the bit-coded selection and activation of a parameterised setpoint (preset value). Trigger = FALSE: selection bit = "0". Trigger = TRUE: selection bit = "1".
	<b>15</b> Digital input 5	
0x2634:001 (P420.01)	Digital outputs function: Relay (Dig.out.function Relay function) – For further possible settings see parameter 0x2634:001 (P420.01).	Assignment of a trigger to the relay. Trigger = FALSE: X9/NO-COM open and NC-COM closed. Trigger = TRUE: X9/NO-COM closed and NC-COM open. Notes: – An inversion set in 0x2635:001 (P421.01)is taken into consideratio here. TRUE if variable speed drive is ready for operation (no error active and DC-bus voltage ok). Otherwise FALSE.
	<b>51</b> Ready for operation	
0x2634:002 (P420.02)	Digital outputs function: Digital output 1 (Dig.out.function: DO1 function) – For further possible settings see parameter 0x2634:001 (P420.01).	Assignment of a trigger to digital output 1. Trigger = FALSE: X3/DO1 set to LOW level. Trigger = TRUE: X3/DO1 set to HIGH level. Notes: – An inversion set in 0x2635:002 (P421.02) is taken into consideration here.
	<b>115</b> Release holding brake	
	100 Sequencer controlled	
		The control is executed via the sequencer (according to the configuration of the digital outputs for the current segment). ► For details see chapter "Segment configuration"

All functional possible settings for controlling the variable speed drive are described in the "Flexible I/O configuration" chapter.

#### 5.4 KEYPAD PARAMETER LIST

For commissioning or diagnostics using the keypad, all parameters of the variable speed drive that can also be accessed by means of the keypad are listed in the following "Keypad parameter list".

- The keypad parameter list is sorted in ascending order in compliance with the "display code" (Pxxx).
- In order to provide for quick access, all parameters of the variable speed drive are divided into different groups according to their function.
- Group 0 contains the configurable "Favorites". In the default settings these are the most common parameters for the solution of typical applications.
  - ▶ For details see chapter "Favorites".
- Based on the hundreds digit of the display code (Pxxx) you can quickly see in which group the parameter is to be found on the keypad:

Parameter	Group - name	Description
P1xx	Group 1 - Diagnostic	Diagnostic/display parameters for displaying device-internal process factors, current actual values, and status messages. ▶ For details see chapter "Diagnostics parameter"
P2xx	Group 2 - Basic settings	Setting of the mains voltage, selection of the control and setpoint source, starting and stopping performance, frequency limits and ramp times. ▶ For details see chapter "Basic setting"
P3xx	Group 3 - Motor control	Configuration of the motor and motor control ▶ For details see chapter "Motor control"
P4xx	Group 4 - I/O settings	Function assignment and configuration of the inputs and outputs ▶ For details see chapter "Flexible I/O configuration"
P5xx	Group 5 - Network settings	Configuration of the network (if available)
P6xx	Group 6 - Process controller	Configuration of the process controller ▶ For details see chapter "Configuring the process controller"
P7xx	Group 7 - Additional functions	Parameterisable additional functions ▶ For details see chapter "Additional functions"
P8xx	Group 8 - Sequencer	The "sequencer" function serves to define a programmed sequence of speed setpoints, PID setpoints or torque setpoints for the motor control. Switching to the next setpoint can be executed in a time-based or event-based manner. ▶ For details see chapter "Sequencer"

1585 GB 09 18

#### FREQUENTLY USED ABBREVIATIONS IN THE SHORT KEYPAD DESIGNATIONS OF THE PARAMETERS:

Abbreviation	Meaning
AI	Analog input
AO	Analog output
B0, B1, ...	Bit 0, bit 1, ...
CU	Control unit
DI	Digital input
DO	Digital output
LU	Undervoltage
MOP	Motor potentiometer
NET	Network
OU	Overvoltage
PID	Process controller
PU	Power unit
QSP	Quick stop
Setp	Setpoint
WD	Watchdog

#### 5.5 SAVE PARAMETER SETTINGS IN THE MEMORY

##### 5.5.1 SAVE PARAMETER SETTINGS WITH KEYPAD

If one parameter setting has been changed with the keypad but has not been saved in the memory with mains failure protect on, the SET display is blinking.

In order to save parameter settings in the user memory of VLA1, press the keypad enter key longer than 3 s.













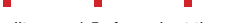

## 6 DIAGNOSTICS AND FAULT ELIMINATION

### 6.1 LED STATUS DISPLAY

The "RDY" and "ERR" LED status displays on the front of the VLA1 provide some quick information about certain operating states.

1585 GB 09 18

"RDY" LED (blue)	"ERR" LED (red)	Status/meaning
off	off	No supply voltage.
 on	 on	Initialisation (variable speed drive is started.)
 blinking (2 Hz)	off	Drive inhibited.
	 blinking fast (4 Hz)	Drive disabled, warning active. ► For details see chapter "Error handling"
	 on	Drive disabled, error active. ► For details see chapter "Error handling"
	 lit every 1.5s for a short time	Drive inhibited, no DC-bus voltage.
 on	 on for a short time every 1s	USB module is connected, 5-V supply voltage for the USB module is available.
	off	Drive enabled. The motor rotates according to the specified setpoint or quick stop active.
	 blinking fast (4 Hz)	Drive enabled, warning active. The motor rotates according to the specified setpoint or quick stop active.
 blinking (1 Hz)	 blinking (1 Hz)	Drive enabled, quick stop as response to fault active.
	 Both LEDs are blinking in a rapidly alternating mode	Firmware update active. ► For details see chapter "Firmware download"
 Both LEDs are blinking in a very rapidly synchronous mode		"Visual tracking" function is active. ► For details see chapter "Optical device identification"

## 6.2 DIAGNOSTICS PARAMETER

The variable speed drive provides many diagnostic parameters which are helpful for operation, maintenance, error diagnosis, error correction, etc.

- In the following overview the most common diagnostic parameters are listed. For the keypad you can find these diagnostic parameters in group 1.
- Further parameters for more specific diagnostic purposes are described in the following subchapters.
- The diagnostic parameters can only be read and cannot be written to.

1585 GB 09 18

Parameter	Name / value range / [default setting]	Info
0x2030	CRC parameter set – Read only	Display of the 32-bit hash sum for the integrity check of the parameter set.
0x2B0B	Frequency setpoint – Read only: x.x Hz	Display of the actual frequency setpoint that is internally transferred to the motor control (after scaling and ramp generator).
0x2B0E (P102.00)	Frequency setpoint (Freq. setpoint) – Read only: x.x Hz	Display of the frequency setpoint currently assigned. – Depending on the present operating conditions this value may differ from the current output frequency 0x2DDD (P100.00).
0x2B0F	VFC output frequency – Read only: x.x Hz	Display of the current output frequency at V/f operation
0x2D4F (P123.00)	Motor utilisation ( $i^2 \cdot t$ ) (Mot. i2t utilis.) – Read only: x %	Display of the current thermal motor utilisation
0x2D87 (P105.00)	DC-bus voltage (DC-bus voltage) – Read only: x V	Display of the current DC-bus voltage.
0x2D88 (P104.00)	Motor current (Motor current) – Read only: x.x A	Display of present current-r.m.s. value.
0x2D89 (P106.00)	Motor voltage (Motor voltage) – Read only: x VAC	Display of the current motor voltage.
0x2DA2:001 (P108.01)	Output power: Effective power (Output power: Effective power) – Read only: x.xxx kW	Display of the active output power for an energy analysis in the respective application
0x2DA2:002 (P108.02)	Output power: Apparent power (Output power: Apparent power) – Read only: x.xxx kVA	Display of the apparent output power for an energy analysis in the respective application.
0x2DA3:001 (P109.01)	Output energy: Motor (Output energy: Motor) – Read only: x.xx kWh	Display of the output power in motor mode for an energy analysis in the respective application.
0x2DA3:002 (P109.02)	Output energy: Generator (Output energy: Generator) – Read only: x.xx kWh	Display of the output power in generator mode for an energy analysis in the respective application.
0x2DDD (P100.00)	Output frequency (Output frequency) – Read only: x.x Hz	Display of the current output frequency for diagnostics of the control.
0x400D (P101.00)	Scaled actual value (Scaled act value) – Read only: x Units	Display of the current speed in application units.
0x6077 (P107.00)	Torque actual value (Torque actual) – Read only: x.x % – 100 % $\equiv$ Motor rated torque 0x6076 (P325.00)	Display of the current torque.
0x6078 (P103.00)	Current actual value (Current actual) – Read only: x.x % – 100 % $\equiv$ Motor rated current 0x6075 (P323.00)	Display of the present motor current.

### 6.2.1 LOGBOOK

For diagnostic purposes, the logbook contains the last 32 error messages and warning signals of the variable speed drive, which have occurred during operation.

Precondition

The logbook can only be accessed via the user interface of VLBX SW software ("Diagnostic" tab).

Details

In contrast to the error history buffer the logbook additionally protocols the following events:

- Fault messages
- Change-over from normal to setup mode (and vice versa)
- Execution of device commands
- Avoidance of safety function

The logbook entries are saved persistently in the VLA1. If all 32 memory units are occupied, the oldest entry is deleted for a new entry. By means of the "Delete logbook" device command, all logbook entries can be deleted.

Parameter	Name / value range / [default setting]	Info
0x2022:015 (P700.15)	Device commands: Delete logbook (Device commands: Delete logbook) – Setti can only be changed if the inverter is inhibited.	1 = delete all entries in the logbook.
	<b>0</b> Off / ready	
	1 On / start	

## 6.2.2 ERROR HISTORY BUFFER



For purposes of diagnostics, the error history buffer contains the last 32 error and warning messages of the variable speed drive, which have occurred during operation. The error history buffer can be read out using the keypad via P155.00 and provides a limited view on the logbook.

### Details

- For each event that is recorded, the error history buffer contains the message text, the error code, the time of occurrence as well as a counter for successive, identical events. If an event that has already been recorded occurs repeatedly, only the counter is incremented.
- The error history buffer can be reset by the user.
- Observe that the error history buffer only presents a snapshot at the time the data are read out. If a new event occurs, the error history buffer must be read out again via P155.00 so that the new event becomes visible.

1585 GB 09 18

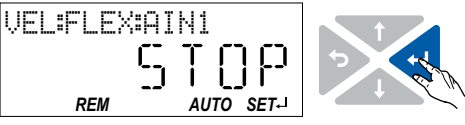
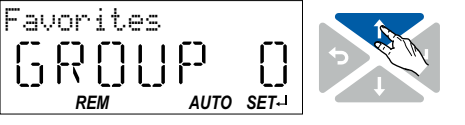
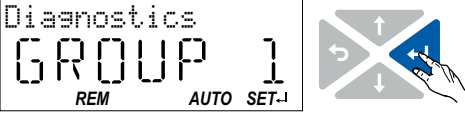
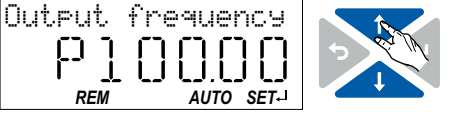
### Accessing the error history buffer with the keypad

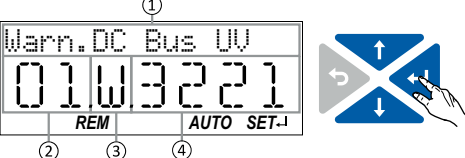
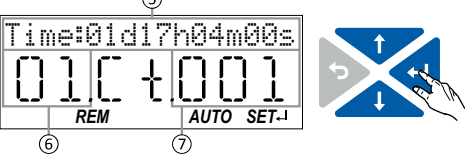
1. 
2. 
3. 
4. 
5. 
6. 
7. 

1. Use the → key in the operating mode to navigate to the parameterisation mode one level below.  
You are now in the group level. All parameters of the VLA1 are divided into different groups according to their function.  
Note: By using the ← key you can navigate one level upwards again anytime
2. Use the ↑ navigation key to select group 1 ("Diagnostics")
3. Use the → key to navigate to one level below.  
You are now in the parameter level of the group selected.
4. Use the ↑ and ↓ select the P155.00 parameter.
5. Use the → key to navigate to one level below. You are now in the error history buffer entries.
6. Use the ↑ and ↓ navigation keys you can now scroll through the error history buffer entries.  
Use the → key, you can switch over the display.

#### Information displayed (page 1):

- ① Message text
- ② No. of the entry (01 = latest event)
- ③ Response (W = warning, T = trouble, F = fault)
- ④ Error code

#### Information displayed (page 2):

- ⑤ Time of occurrence
- ⑥ No. of the entry (01 = latest event)
- ⑦ Counter for successive, identical events

Note: By using the ← key you can exit the error history buffer again.

Parameter	Name / value range / [default setting]	Info
0x2006:000 (P155.00)	Error history buffer: Keypad display (Fault memory: Error memory) – Read only	Display of the error history buffer on the keypad.

### 6.2.3 VARIABLE SPEED DRIVE DIAGNOSTICS

The following parameters supply some information about the current operating status of the variable speed drive.

This includes the following information:

- Currently loaded parameter settings
- Cause(s) for disable, quick stop and stop.
- Active control source and active setpoint source
- Active operatin mode
- Keypad status
- Status of the internal motor control

Some of the following parameters contain bit-coded status words. Each single bit has a certain meaning.







► For details see chapter "Display of status words on keypad".

1585 GB 09 18

Parameter	Name / value range / [default setting]	Info
0x2827 (P198.00)	Currently loaded parameter settings (Status load. par) – Read only	Display of the parameter settings currently loaded. ► See chapter "Data handling" ► See chapter "Saving/loading the parameter settings"
	0 User settings	User parameter settings of the memory module
	1 Reset 60 Hz setting	Delivery status (default setting) for 50-Hz device
	2 Reset 50 Hz setting	Delivery status (default setting) for 60-Hz device
	3 OEM default setting	OEM parameter settings of the memory module
0x282A:001 (P126.01)	Status words: Cause of disable (Status words: Cause of disable) – Read only	Bit-coded display of the cause(s) for disabled inverter.
	Bit 0 Flexible I/O configuration	1 ≙ the drive was disabled by the trigger set in 0x2631:001 (P400.01).
	Bit 1 Network	1 ≙ the drive was disabled via network.
	Bit 2 Axis command	1 ≙ the drive was disabled via axis command .
	Bit 6 Fault DC-bus	1 ≙ the drive was inhibited due to a DC-bus error.
	Bit 7 Drive not ready	1 ≙ the drive was disabled internally since the drive was not ready for operation Possible causes: – Under/overvoltage in the DC bus – Defect device hardware
	Bit 8 Quick stop active	1 ≙ the drive has been disabled by the "Quick stop" function.
	Bit 9 Motor data identification	1 ≙ the drive was disabled by the "Automatic identification of the motor data" function.
	Bit 10 Automatic holding brake control	1 ≙ the drive was disabled by the "Holding brake control" function.
	Bit 11 DC braking	–
	Bit 12 ... Bit 15 Not used	
0x282A:002 (P126.02)	Status words: Cause of quick stop (Status words: Cause of QSP) – Read only	Bit coded display of the cause(s) of quick stop.
	Bit 0 Flexible I/O configuration	1 ≙ quick stop was activated by the trigger set in 0x2631:003 (P400.03).
	Bit 1 Network	1 ≙ quick stop was activated via network.
	Bit 2 Axis command	1 ≙ quick stop was activated via axis command .
	Bit 6 Error response	1 ≙ quick stop has been activated as a response to an error.
0x282A:003 (P126.03)	Status words: Cause of stop (Status words: Cause of stop) – Read only	Bit coded display of the cause(s) of stop.
	Bit 0 Flexible I/O: Start disabled	1 ≙ stop was activated by the trigger set in 0x2631:002 (P400.02).
	Bit 1 Flexible I/O: Run forward	1 ≙ stop has been activated due to cancellation of the command "Run forward (CW)".
	Bit 2 Flexible I/O: Run reverse	1 ≙ stop has been activated due to cancellation of the command "Run reverse (CCW)".
	Bit 3 Flexible I/O: Jog forward	1 ≙ stop has been activated due to cancellation of the command "Jog foward (CW)".
	Bit 4 Flexible I/O: Jog reverse	1 ≙ stop has been activated due to cancellation of the command "Jog reverse (CCW)".
	Bit 5 Network	1 ≙ stop was activated via network (if available).
	Bit 6 Keypad	1 ≙ stop was activated via keypad.
	Bit 7 Control mode transition	1 ≙ stop has been activated due to a change of the operatin mode.
	Bit 8 End of sequence	1 ≙ stop was activated by the "sequencer" function since the sequence is completed. – The bit is only set after the sequence is completed if End of sequence mode 0x402F (P824.00) is set = "Stop [1]" or "Stop and abort [2]".
Bit 15 Waiting for start	1 ≙ Stop is active as a start command is not yet available (e.g. after enabling the drive).	
0x282A:005 (P126.05)	Status words: Device status (Status words: Device status) – Read only	Display of the current device state.
	0 Initialisation	
	2 Not ready to switch on	
	3 Switch on disabled	
	4 Ready to switch on	
	5 Switched on	
	6 Operation enabled	
	7 Disable operation	
	8 Shut down	
	9 Quick stop active	
	10 Fault reaction active	
	11 Fault	



Parameter	Name / value range / [default setting]	Info	
0x282B:001 (P125.01)	Active control source – Read only	Display of the control source that is currently active	
	0 Flexible I/O configuration		
	1 Network		
	2 Keypad		
	8 Keypad full control		
0x282B:002 (P125.02)	Active setpoint source – Read only	Display of the setpoint source that is currently active	
	0 Not selected		
	1 Analog input 1		
	2 Analog input 2		
	3 Keypad Setpoint		
	4 HTL input		
	5 Network Setpoint		
	11 Setpoint preset 1		
	12 Setpoint preset 2		
	13 Setpoint preset 3		
	14 Setpoint preset 4		
	15 Setpoint preset 5		
	16 Setpoint preset 6		
	17 Setpoint preset 7		
	18 Setpoint preset 8		
	19 Setpoint preset 9		
	20 Setpoint preset 10		
	21 Setpoint preset 11		
	22 Setpoint preset 12		
	23 Setpoint preset 13		
	24 Setpoint preset 14		
	25 Setpoint preset 15		
	31 Segment preset 1		
	32 Segment preset 2		
	33 Segment preset 3		
	34 Segment preset 4		
	35 Segment preset 5		
	36 Segment preset 6		
	37 Segment preset 7		
	38 Segment preset 8		
	39 Last segment		
	50 Motor potentiometer		
	51 PID setpoint		
201 Internal value			
202 Internal value			
203 Internal value			
204 Internal value			
205 Internal value			
206 Internal value			
0x282B:003 (P125.03)	Keypad LCD status – Read only	Bit-coded state of the keypad status displays.	
	Bit 0 LOC		1 ≙ local keypad control active
	Bit 1 REM		1 ≙ remote control via terminals, etc. active.
	Bit 2 MAN		1 ≙ manual setpoint selection via keypad active
	Bit 3 Auto		1 ≙ automatic setpoint selection via terminals, etc. active.
	Bit 4 Set		1 ≙ a parameter setting has been changed but not been saved yet in the memory with mains failure protection.

Parameter	Name / value range / [default setting]	Info
0x282B:004 (P125.04)	Active drive mode – Read only	Display of the active drive mode.
	0 Velocity mode	"Velocity mode" active
	1 PID control	PID control active
	2 Torque mode	"Torque mode" active
	4 Jog operation	"Jog forward (CW)" or "Jog reverse (CCW)" function active
0x293A (P116.00)	Actual switching frequency (Actual sw. freq.) – Read only	Display of the currently active switching frequency.  Example: – "16 kHz variable / drive-optimised / 4 kHz min. [22]" is selected as switching frequency in 0x2939 (P305.00). – An increase of the ambient temperature and/or the load have caused a decrease of the switching frequency to 8 kHz. In this case, this parameter indicates the selection "8 kHz power loss-optimised [7]".
	1 2 kHz drive-optimised	
	2 4 kHz drive-optimised	
	3 8 kHz drive-optimised	
	4 16 kHz drive-optimised	
	5 2 kHz power loss-optimised	
	6 4 kHz power loss-optimised	
	7 8 kHz power loss-optimised	
	8 16 kHz power loss-optimised	
0x2DAC (P119.00)	Keypad status (Keypad status) – Read only	Bit-coded display of the keypad status.
	Bit 0 Start Key	1 ≙ keypad start key  pressed.
	Bit 1 Stop Key	1 ≙ keypad stop key  pressed.
	Bit 2 Up arrow	1 ≙ keypad up-arrow key  pressed.
	Bit 3 Down arrow	1 ≙ keypad down-arrow key  pressed.
	Bit 4 Enter Key	1 ≙ keypad enter key  pressed.
	Bit 5 Back key	1 ≙ keypad back key  pressed.

Parameter	Name / value range / [default setting]	Info
0x2DAD (P120.00)	Internal hardware states (Int. HW states) – Read only	Bit-coded display of internal hardware states.
	Bit 0 Relay	0 ≙ X9/NO-COM open and NC-COM closed. 1 ≙ X9/NO-COM closed and NC-COM open.
	Bit 1 Digital output 1	0 ≙ LOW level, 1 ≙ HIGH level.
	Bit 10 Charge Relay	1 ≙ precharging of the DC bus via charge relay is active
0x603F (P150.00)	Error code (Error code) – Read only	Error message

## 6.2.5 DIAGNOSTICS OF THE INPUTS AND OUTPUTS

### 6.2.5.1 DIGITAL INPUTS AND OUTPUTS

The following parameters serve to diagnose the digital inputs and outputs of the variable speed drive.

Parameter	Name / value range / [default setting]	Info
0x60FD (P118.00)	Digital inputs (Digital inputs) – Read only	Bit coded display of the current state of the digital inputs
	Bit 16 Level from digital input 1	0 ≙ LOW level, 1 ≙ HIGH level.
	Bit 17 Level from digital input 2	
	Bit 18 Level from digital input 3	
	Bit 19 Level from digital input 4	
	Bit 20 Level from digital input 5	
Bit 25 Internal interconnection of digital inputs	0 ≙ digital input terminals are set to HIGH level via pull-up resistors. 1 ≙ digital input terminals are set to LOW level via pull-down resistors.	

#### Related topics

- ▶ See chapter "Configuration of digital inputs".
- ▶ See chapter "Configuration of digital outputs".

## 6.2.5.2 ANALOG INPUTS AND OUTPUTS

The following parameters serve to diagnose the analog inputs and outputs of the variable speed drive.

Parameter	Name / value range / [default setting]	Info																								
0x2DA4:001 (P110.01)	Diagnostics of analog input 1: Value in percent (AI1 diagnostics: AI1 terminal %) – Read only: x.x %	Display of the current input value at X3/AI1 scaled as value in percent. – 100 % ≡ 10 V or 20 mA or 5 V																								
0x2DA4:002 (P110.02)	Diagnostics of analog input 1: Frequency value (AI1 diagnostics: AI1 scaled freq.) – Read only: x.x Hz	Display of the current input value at X3/AI1 scaled as a frequency value. – The standard setpoint source for operating mode 0x6060 (P301.00) = "MS: Velocity mode [-2]" is selected in 0x2860:001 (P201.01).																								
0x2DA4:003 (P110.03)	Diagnostics of analog input 1: Process controller value (AI1 diagnostics: AI1 scaled PID) – Read only: x.xx PID unit	Display of the current input value at X3/AI1 scaled as a process controller value. – The standard setpoint source for the reference value of PID control is selected in 0x2860:002 (P201.02).																								
0x2DA4:004 (P110.04)	Diagnostics of analog input 1: Torque value (AI1 diagnostics: AI1 scaled torq.) – Read only: x.x %	Display of the current input value at X3/AI1 scaled as a percentage torque value. – 100 % ≡ permissible maximum torque 0x6072 (P326.00) – The standard setpoint source for operating mode 0x6060 (P301.00) = "MS: Torque mode [-1]" is selected in 0x2860:003 (P201.03).																								
0x2DA4:016 (P110.16)	Diagnostics of analog input 1: Status (AI1 diagnostics: AI1 status) – Read only <table border="1" style="width: 100%; border-collapse: collapse;"> <tr><td>Bit 0</td><td>Mode 0: 0 ... 10 VDC active</td></tr> <tr><td>Bit 1</td><td>Mode 1: 0 ... 5 VDC active</td></tr> <tr><td>Bit 2</td><td>Mode 2: 2 ... 10 VDC active</td></tr> <tr><td>Bit 3</td><td>Mode 3: -10 ... 10 VDC active</td></tr> <tr><td>Bit 4</td><td>Mode 4: 4 ... 20 mA active</td></tr> <tr><td>Bit 5</td><td>Mode 5: 0 ... 20 mA active</td></tr> <tr><td>Bit 6</td><td>24 V supply OK</td></tr> <tr><td>Bit 7</td><td>Calibration successful</td></tr> <tr><td>Bit 8</td><td>Monitoring threshold exceeded/not reached</td></tr> <tr><td>Bit 9</td><td>Input current too low (mode 4)</td></tr> <tr><td>Bit 10</td><td>Input voltage too low (mode 2)</td></tr> <tr><td>Bit 11</td><td>Input voltage too high (mode 4)</td></tr> </table>	Bit 0	Mode 0: 0 ... 10 VDC active	Bit 1	Mode 1: 0 ... 5 VDC active	Bit 2	Mode 2: 2 ... 10 VDC active	Bit 3	Mode 3: -10 ... 10 VDC active	Bit 4	Mode 4: 4 ... 20 mA active	Bit 5	Mode 5: 0 ... 20 mA active	Bit 6	24 V supply OK	Bit 7	Calibration successful	Bit 8	Monitoring threshold exceeded/not reached	Bit 9	Input current too low (mode 4)	Bit 10	Input voltage too low (mode 2)	Bit 11	Input voltage too high (mode 4)	Bit-coded display of the status of analog input 1 (X3/AI1).
Bit 0	Mode 0: 0 ... 10 VDC active																									
Bit 1	Mode 1: 0 ... 5 VDC active																									
Bit 2	Mode 2: 2 ... 10 VDC active																									
Bit 3	Mode 3: -10 ... 10 VDC active																									
Bit 4	Mode 4: 4 ... 20 mA active																									
Bit 5	Mode 5: 0 ... 20 mA active																									
Bit 6	24 V supply OK																									
Bit 7	Calibration successful																									
Bit 8	Monitoring threshold exceeded/not reached																									
Bit 9	Input current too low (mode 4)																									
Bit 10	Input voltage too low (mode 2)																									
Bit 11	Input voltage too high (mode 4)																									
0x2DA5:001 (P111.01)	Diagnostics of analog input 2: Value in percent (AI2 diagnostics: AI2 terminal %) – Read only: x.x %	Display of the current input value at X3/AI2 scaled as a value in percent. – 100 % ≡ 10 V or 20 mA or 5 V																								
0x2DA5:002 (P111.02)	Diagnostics of analog input 2: Frequency value (AI2 diagnostics: AI2 scaled freq.) – Read only: x.x Hz	Display of the current input value at X3/AI2 scaled as a frequency value. – The standard setpoint source for operating mode 0x6060 (P301.00) = "MS: Velocity mode [-2]" is selected in 0x2860:001 (P201.01).																								
0x2DA5:003 (P111.03)	Diagnostics of analog input 2: Process controller value (AI2 diagnostics: AI2 scaled PID) – Read only: x.xx PID unit	Display of the current input value at X3/AI2 scaled as a process controller value. – The standard setpoint source for the reference value of PID control is selected in 0x2860:002 (P201.02).																								
0x2DA5:004 (P111.04)	Diagnostics of analog input 2: Torque value (AI2 diagnostics: AI2 scaled torq.) – Read only: x.x %	Display of the current input value at X3/AI2 scaled as a percentage torque value. – 100 % ≡ permissible maximum torque 0x6072 (P326.00)																								
0x2DA5:016 (P111.16)	Diagnostics of analog input 2: Status (AI2 diagnostics: AI2 status) – Read only <table border="1" style="width: 100%; border-collapse: collapse;"> <tr><td>Bit 0</td><td>Mode 0: 0 ... 10 VDC active</td></tr> <tr><td>Bit 1</td><td>Mode 1: 0 ... 5 VDC active</td></tr> <tr><td>Bit 2</td><td>Mode 2: 2 ... 10 VDC active</td></tr> <tr><td>Bit 3</td><td>Mode 3: -10 ... 10 VDC active</td></tr> <tr><td>Bit 4</td><td>Mode 4: 4 ... 20 mA active</td></tr> <tr><td>Bit 5</td><td>Mode 5: 0 ... 20 mA active</td></tr> <tr><td>Bit 6</td><td>24 V supply OK</td></tr> <tr><td>Bit 7</td><td>Calibration successful</td></tr> <tr><td>Bit 8</td><td>Monitoring threshold exceeded/not reached</td></tr> <tr><td>Bit 9</td><td>Input current too low</td></tr> <tr><td>Bit 10</td><td>Input voltage too low</td></tr> <tr><td>Bit 11</td><td>Input voltage too high</td></tr> </table>	Bit 0	Mode 0: 0 ... 10 VDC active	Bit 1	Mode 1: 0 ... 5 VDC active	Bit 2	Mode 2: 2 ... 10 VDC active	Bit 3	Mode 3: -10 ... 10 VDC active	Bit 4	Mode 4: 4 ... 20 mA active	Bit 5	Mode 5: 0 ... 20 mA active	Bit 6	24 V supply OK	Bit 7	Calibration successful	Bit 8	Monitoring threshold exceeded/not reached	Bit 9	Input current too low	Bit 10	Input voltage too low	Bit 11	Input voltage too high	Bit-coded display of the status of analog input 2 (X3/AI2).
Bit 0	Mode 0: 0 ... 10 VDC active																									
Bit 1	Mode 1: 0 ... 5 VDC active																									
Bit 2	Mode 2: 2 ... 10 VDC active																									
Bit 3	Mode 3: -10 ... 10 VDC active																									
Bit 4	Mode 4: 4 ... 20 mA active																									
Bit 5	Mode 5: 0 ... 20 mA active																									
Bit 6	24 V supply OK																									
Bit 7	Calibration successful																									
Bit 8	Monitoring threshold exceeded/not reached																									
Bit 9	Input current too low																									
Bit 10	Input voltage too low																									
Bit 11	Input voltage too high																									
0x2DAA:001 (P112.01)	Diagnostics of analog output 1: Voltage (AO1 diagnostics: AO1 Voltage) – Read only: x.xx V	Display of the current output voltage at X3/AO1.																								
0x2DAA:002 (P112.02)	Diagnostics of analog output 1: Current (AO1 diagnostics: AO1 Current) – Read only: x.xx mA	Display of the present output current at X3/AO1.																								

### Related topics

- ▶ See chapter "Configuration of analog inputs"
- ▶ See chapter "Configuration of analog outputs"

## 6.2.8 PROCESS CONTROLLER STATUS

The following parameters serve to diagnose the process controller.

Parameter	Name / value range / [default setting]	Info	
0x401F:001 (P121.01)	Current setpoint (PID setpoint) – Read only: x.xx PID unit	Display of the current reference value (setpoint) for the process controller.	
0x401F:002 (P121.02)	Current process variable (PID process var.) iRead only: x.xx PID unit	Display of the current controlled variable (actual value) fed back for the process controller.	
0x401F:003 (P121.03)	Status (PID status) – Read only	Bit-coded status display of the process controller.	
	Bit 0		Process controller off
	Bit 1		PID output set to 0
	Bit 2		PID I-component inhibited
	Bit 3		PID influence active
	Bit 4		Setpoint = actual value
	Bit 5		Idle state active
	Bit 6		Max. alarm
Bit 7	Min. alarm		

### Related topics

- See chapter "Configuring the process controller".

## 6.2.9 SEQUENCER DIAGNOSTIC

The following parameters serve to diagnose the "sequencer" function.

Parameter	Name / value range / [default setting]	Info
0x2DAE:001 (P140.01)	Sequencer diagnostics: Active step (Sequencer diag: Active Step) – Read only	Display of the active step. – 0 ≙ no sequence active
0x2DAE:002 (P140.02)	Sequencer diagnostics: Step time elapsed (Sequencer diag: StepTime elapsed) – Read only: x.x s	Display of the time that has passed since the start of the current step.
0x2DAE:003 (P140.03)	Sequencer diagnostics: Step time remaining (Sequencer diag: StepTime remain) – Read only: x.x s	Display of the residual time for the current step.
0x2DAE:004 (P140.04)	Sequencer diagnostics: Steps complete (Sequencer diag: Steps complete) – Read only	Display of the number of steps that have been made since the start of the sequence.
0x2DAE:005 (P140.05)	Sequencer diagnostics: Steps remaining (Sequencer diag: Steps remain) – Read only	Display of the residual number of steps until the current sequence is completed. This includes the current step.
0x2DAE:006 (P140.06)	Sequencer diagnostics: Active sequence (Sequencer diag: Active sequence) – Read only	Display of the active sequence. – 0 ≙ no sequence active
0x2DAE:007 (P140.07)	Sequencer diagnostics: Active segment (Sequencer diag: Active segment) – Read only	Display of the active segment. – 0 ≙ no sequence active – 255 ≙ final sequence active
0x2DAE:008 (P140.08)	Sequencer diagnostics: Relative sequence time remaining (Sequencer diag: SeqTime remain %) – Read only: x %	Display of the residual time of the sequence in [%].
0x2DAE:009 (P140.09)	Sequencer diagnostics: Absolute sequence time remaining (Sequencer diag: SeqTime remain) – Read only: x.x s	Display of the residual time of the sequence in [s].

### Related topics

- See chapter "Sequencer".
- See chapter "Sequencer control functions".

## 6.2.10 DEVICE IDENTIFICATION

The following parameters show some general information about the variable speed drive.

Parameter	Name / value range / [default setting]	Info
0x2000:001 (P190.01)	Device data: Product code (Device data: Product code) – Read only	Product code of the variable speed drive. Example: "VLA1 04 A240"
0x2000:002 (P190.02)	Device data: Serial number (Device data: Serial number) – Read only	Serial number of the variable speed drive. Example: "0000000000000000XYZXYZ"
0x2000:004 (P190.04)	Device data: CU firmware version (Device data: CU firmware ver.) – Read only	Firmware version of the control unit. Example: "05.02.00.10"
0x2000:005 (P190.05)	Device data: CU firmware type (Device data: CU firmware type) – Read only	Firmware type of the control unit. Example: "IOFW52L030"
0x2000:006 (P190.06)	Device data: CU bootloader version (Device data: CU bootldr ver.) – Read only	Bootloader version of the control unit. Example: "00.00.00.18"
0x2000:007 (P190.07)	Device data: CU bootloader type (Device data: CU bootldr type) – Read only	Bootloader type of the control unit. Example: "IOBL51A0nn"
0x2000:008 (P190.08)	Device data: Object directory version (Device data: OBD version) – Read only	Example: "250123"
0x2000:010 (P190.10)	Device data: PU firmware version (Device data: PU firmware ver.) – Read only	Firmware version of the power unit. Example: "00228"
0x2000:011 (P190.11)	Device data: PU firmware type (Device data: PU firmware type) – Read only	Firmware type of the power unit. Example: "IDFW5XXXXX"
0x2000:012 (P190.12)	Device data: PU bootloader version (Device data: PU bootldr ver.) – Read only	Bootloader version of the power unit.
0x2000:013 (P190.13)	Device data: PU bootloader type (Device data: PU bootldr type) – Read only	Bootloader type of the power unit.
0x2000:014 (P190.14)	Device data: Module firmware – Read only	Firmware version of the plugged-in module (e. g. USB module).
0x2000:015 (P190.15)	Device data: Firmware revision number (Device data: FW revision nr.) – Read only	Firmware version of the network option (if available).
0x2000:016 (P190.16)	Device data: Bootloader revision number (Device data: Bootloader revNo) – Read only	Bootloader version of the network option (if available).
0x2001 (P191.00)	Device name (Device name) ["My Device"]	Any device name (e.g. "Wheel drive") can be set in this object for the purpose of device identification.

1585 GB 09 18

### 6.2.11 DEVICE OVERLOAD MONITORING (I\*T)

The variable speed drive calculates the I\*t utilisation in order to protect itself against thermal overload. In simple terms: a higher current or an overcurrent that continues for a longer time causes a higher I\*t utilisation.

#### DANGER!

Uncontrolled motor movements by pulse inhibit.

When the device overload monitoring function is activated pulse inhibit is set and the motor becomes torqueless. A load that is connected to motors without a holding brake may therefore cause uncontrolled movements! Without a load, the motor will coast.

- Only operate the variable speed drive under permissible load conditions.

#### Details

The device overload monitoring function primarily offers protection to the power section. Indirectly, also other components such as filter chokes, circuit-board conductors, and terminals are protected against overheating. Short-time overload currents followed by recovery periods (times of smaller current utilisation) are permissible. The monitoring function during operation checks whether these conditions are met, taking into consideration that higher switching frequencies and lower stator frequencies as well as higher DC voltages cause a greater device utilisation.

- If the device utilisation exceeds the warning threshold set in 0x2D40:002 (default setting 95 %), the variable speed drive outputs a warning.
- If the device utilisation exceeds the permanent error threshold 100 %, the variable speed drive is disabled immediately and any further operation is stopped.
- The device overload can be obtained from the configuration document.

Parameter	Name / value range / [default setting]	Info
0x2D40:002	Device utilisation (I*t): Warning threshold 0 ... [95] ... 101 %	If the device utilisation exceeds the threshold set, the variable speed drive outputs a warning. – With the setting 0 % or ≥ 100 %, the warning is deactivated
0x2D40:004 (P135.04)	Device utilisation(I*t) (Device utilisat. Ixt utilisation) – Read only: x %	Display of the current device utilisation.
0x2D40:005 (P135.05)	Device utilisation (I*t): Error response (Device utilisat. Error response)	Selection of the response to be executed when the device overload monitoring function is triggered. Associated error code: – 9090   0x2382 - I*t error
	2 Trouble	► For details see chapter "Error types".
	3 Fault	

### 6.2.12 HEATSINK TEMPERATURE MONITORING

Parameter	Name / value range / [default setting]	Info
0x2D84:001 (P117.01)	Heatsink temperature (Heatsink temp.: Heatsink temp.) – Read only: x.x °C	Display of the current heatsink temperature.
0x2D84:002	Heatsink temperature: Warning threshold 50.0 ... [80.0]* ... 100.0 °C *Default setting depending on the size.	Warning threshold for temperature monitoring. – If the heatsink temperature exceeds the threshold set here, the variable speed drive outputs a warning. – The warning is reset with a hysteresis of approx. 5 °C. – If the heatsink temperature increases further and exceeds the non-adjustable error threshold (100 °C), the variable speed drive changes to the "Fault" device status. The variable speed drive is disabled and thus any further operation is stopped.

### 6.2.13 LIFE-DIAGNOSIS

The following parameters provide some information about the use of the variable speed drive. This includes the following information:

- Operating and power-on time of the variable speed drive
- Operating time of the internal fan
- Number of switching cycles of the mains voltage
- Number of switching cycles of the relay
- Number of short-circuits and earth faults that have occurred
- Display of the number of "Imax: Clamp responded too often errors that have occurred.

Parameter	Name / value range / [default setting]	Info
0x2D81:001 (P151.01)	Life-diagnosis: Operating time (Life-diagnosis: Operating time) – Read only: x s	Display showing for how long the variable speed drive has been running so far "Operation enabled" device state).
0x2D81:002 (P151.02)	Life-diagnosis: Power-on time (Life-diagnosis: Power-on time) – Read only: x s	Display showing for how long the variable speed drive has been supplied with mains voltage so far.
0x2D81:003 (P151.03)	Life-diagnosis: Control unit operating time (Life-diagnosis: CU oper. time) – Read only: x ns	Display showing how long the control unit of the variable speed drive has been supplied with voltage via the USB module. Display showing how long the control unit of the variable speed drive has been switched on for so far.
0x2D81:004 (P151.04)	Life-diagnosis: Main switching cycles (Life-diagnosis: Switching cycles) – Read only	Display of the number of switching cycles of the mains voltage.
0x2D81:005 (P151.05)	Life-diagnosis: Relay switching cycles (Life-diagnosis: Relay cycles) – Read only	Display of the number of switching cycles of the relay.
0x2D81:006 (P151.06)	Life-diagnosis: Short-circuit counter (Life-diagnosis: Short-circ.count) – Read only	Display of the number of short circuits that have occurred.
0x2D81:007 (P151.07)	Life-diagnosis: Earth fault counter (Life-diagnosis: Earthfault count) – Read only	Display of the number of earth faults that have occurred.
0x2D81:008 (P151.08)	Life-diagnosis: Clamp active (Life-diagnosis: Clamp active) – Read only	Display of the number of "Imax: Clamp responded too often errors that have occurred. – "Clamp" = short-time inhibit of the drive in V/f operation when the current limit shown in 0x2DDF:002 is reached.
0x2D81:009 (P151.09)	Life-diagnosis: Fan operating time (Life-diagnosis: Fan oper. time) – Read only: x s	Display showing for how long the internal fan has been running so far.

### 6.3 ERROR HANDLING

Many functions integrated in the VLA1 can

- detect errors and thus protect variable speed drive and motor from damages,
- detect an operating error of the user,
- output a warning or information if desired.

#### 6.3.1 ERROR TYPES

In the event of an error, the variable speed drive response is determined by the error type defined for the error.

In the following, the different error types are described.

Error type "No response"

The error is completely ignored (does not affect the running process).

Error type "Warning"

A warning does not severely affect the process and may be also ignored in consideration of safety aspects.

Error type "Fault"

The motor is brought to a standstill with the quick stop ramp.

- The variable speed drive will only be disabled after the quick stop is executed (motor at standstill) or after the time-out time set in 0x2826 has been elapsed. See chapter "Timeout fault reaction".
- Exception: In case of a serious fault, the variable speed drive is disabled immediately. The motor becomes torqueless (coasts). For details see the table "Error codes".

Error type "Trouble"

Just like "Fault", but the error state will be left automatically if the error condition is not active anymore.

- Exception: In case of a severe trouble, the variable speed drive is disabled immediately. The motor becomes torqueless (coasts). For details see the table "Error codes".
- The restart behaviour after trouble can be configured. See chapter "Automatic restart".

Comparison of the error types

The following table compares the main differences of the error types:

Error type	Logging in the Error history buffer / Logbook	VSD disable	Motor stop	Error reset is required	"ERR" LED (red)
No response	No	No	No	No	off
Warning	Yes	No	No	No	■■■■■■■■■■■■■■■■■■■■ blinking fast (4 Hz)
Trouble	Yes	After quick stop or immediately.	Quick stop ramp or coasting.	No	■■ ■■ ■■ ■■ blinking (1 Hz)
Error	Yes	For details see table "Error messages"		Yes	■■■■■■■■■■■■■■■■■■■■ on

#### 6.3.2 ERROR CONFIGURATION

The errors can be divided into two types:

- Errors with predefined error type
- Errors with configurable error type

Especially critical errors are permanently set to the "Fault" error type in order to protect variable speed drive and motor from damages.

In case of errors with configurable error type, the default setting can be changed in consideration of safety aspects and the operational performance. The selection "No response [0]" is, however, only available for minor errors.

The "Error codes" table lists the error type for each error. If the error type can be configured by the user, the "adjustable in" column displays the corresponding parameter.

#### 6.3.3 ERROR RESET

If the error condition is not active anymore, there are several options to reset an active error and thus leave the error state again:

- Via the keypad key . ▶ See chapter "Error reset with keypad".
- Via the trigger assigned to the "Reset fault" function. ▶ See chapter "Reset error".
- Via the button in the software VLBX SW ("Diagnostics" tab).

Notes:

- Certain errors can only be reset by mains switching.
  - Certain errors (e. g. earth fault or short circuit of the motor phases) may cause a blocking time. In this case, the error can be reset only after the blocking time has elapsed.
- The "Error codes" table gives the blocking time (if available) for each error. This table also shows whether mains switching is required for the error reset.

#### 6.3.4 KEYPAD ERROR MESSAGES

If an error is pending, the keypad shows the following information:

Keypad display	Meaning
	① Error text
	② Error type:
	F Fault
	T Trouble
	W Warning
	③ Error code (hexadecimal)
	▶ See chapter "Error codes".
	▶ See chapter "Error reset with keypad".
	After a disturbance, a restart is possible if the error condition is not active anymore. The keypad shows this by the "Restart Pending" note. The note is displayed in a 1-second interval alternatin with the error text.
	▶ See chapter "Timeout fault reaction".

## 6.4 DATA HANDLING

In the following, the behaviour of the variable speed drive is described if the data on the memory do not match the variable speed drive hardware or firmware, for whatever reason. The following points are described in detail here:

- Automatic loading of the parameter settings when the variable speed drive is switched on
- Manual loading of the user data via device command
- Manual loading of the OEM data via device command
- Manual saving of the parameter settings via device command
- Hardware and firmware updates/downgrades

Automatic loading of the parameter settings when the variable speed drive is switched on

Process when the variable speed drive is switched on:

1. The default setting saved in the variable speed drive firmware is loaded.
2. If a memory with valid data is available, the data is loaded from the user memory.

Otherwise a corresponding error message is output:

Error message	Info
0x7682: Memory module: invalid user data	The user parameter settings in the memory module are invalid. Thus, the user parameter settings get lost. The default setting is loaded automatically. Remedy: 1. Execute user parameter settings again. 2. Execute device command "Save user data" 0x2022:003 (P700.03).
0x7684: Data not completely saved before switch-off	Saving the parameter settings was interrupted by an unexpected disconnection. The user parameter settings were not saved completely. When the variable speed drive is switched on the next time, the backup data is copied to the user memory. Remedy: 1. Check user parameter settings. (The loaded backup is an older version.) 2. If required, repeat the changes made last. 3. Execute device command "Save user data" 0x2022:003 (P700.03).
0x7689: Memory module: invalid OEM data	The OEM memory contains invalid parameter settings or is empty. The user parameter settings are loaded automatically. Remedy: - Execute device command "Save OEM data" 0x2022:006 (P700.06). - Thus, the user parameter settings get lost!

### Notes:

- If the memory module contains invalid data, the device commands "Load user data" 0x2022:004 (P700.04) and "Load OEM data" 0x2022:005 (P700.05) are not executed. The status feedback "Action cancelled" takes place.
- If the memory module is empty, the default setting saved in the variable speed drive firmware is loaded. No access is required by the user. The memory module remains empty until the device command "Save user data" 0x2022:003 (P700.03) or "Save OEM data" 0x2022:006 (P700.06) is executed.
- Irrespective of the data on the memory module, the device command "Load default settings" 0x2022:001 (P700.01) is always enabled.

Manual loading of the user data via device command

Device command: "Load user data" 0x2022:004 (P700.04)

- If the user memory contains invalid parameter settings the default setting saved in the variable speed drive firmware is automatically loaded.
- For possible error messages, see the table above.

Manual loading of the OEM data via device command

Device command: "Load OEM data" 0x2022:005 (P700.05)

- If the OEM memory contains invalid parameter settings, the user parameter settings are loaded automatically.
- If the OEM memory is empty, the status feedback "Action cancelled" takes place. The current parameter settings remain unchanged.

Manual saving of the parameter settings via device command

Device command: "Save user data" 0x2022:003 (P700.03)

- It may happen that the parameter settings cannot be saved because the user memory is full. In this case, the following error message appears:

Error message	Info
0x7680: Memory module is full	The memory module contains too many parameter settings. The parameter settings were not saved in the memory module. Remedy: Execute device command "Save user data" 0x2022:003 (P700.03) again. This reinitialises the user memory with the current parameter settings. By this means, parameter settings no longer required are deleted automatically.



## 7 BASIC SETTING

This chapter contains the most frequently used functions and settings to adapt the variable speed drive to a simple application based on the default setting.

### 7.1 MAINS VOLTAGE

The rated mains voltage set for the variable speed drive has an impact on the operating range of the variable speed drive.

**i** The motor does not restart automatically after the overvoltage monitoring function has been activated.

#### Details

By default, the rated mains voltage in 0x2540:001 (P208.01) is set according to the product code of the variable speed drive.

**i** Check the setting of the rated mains voltage in 0x2540:001 (P208.01). Ensure that it matches the actual mains voltage applied!  
For VLA1 series the only possible setting is 230 Veff [0].

#### Monitoring of the DC-bus voltage

- The warning thresholds for monitoring are adjustable.
- The error thresholds and reset thresholds for monitoring result from the rated mains voltage set:

Rated mains voltage	Undervoltage thresholds			Overvoltage thresholds		
	Warning threshold	Error threshold	Reset threshold	Warning threshold	Error threshold	Reset threshold
Setting in 0x2540:001 (P208.01)	Setting in 0x2540:002 (P208.02)	Display in 0x2540:003 (P208.03)	Display in 0x2540:004 (P208.04)	Setting in 0x2540:005 (P208.05)	Display in 0x2540:006 (P208.06)	Display in 0x2540:007 (P208.07)

- If the DC-bus voltage of the variable speed drive falls below the undervoltage error threshold, the "Trouble" response is triggered. The motor behaves in accordance with 0x2838:002 (P203.02).
- If the DC-bus voltage of the variable speed drive exceeds the overvoltage error threshold, the "Fault".

Parameter	Name / value range / [default setting]	Info
0x2540:001 (P208.01)	Mains settings: Rated mains voltage (Mains settings: Mains voltage) – Settings can only be changed if the variable speed drive is inhibited. <b>0   230 Veff</b> 1 400 Ve 2 480 Ve 3 120 Ve	Select on of the mains voltage for actuating the variable speed drive. Note. For VLA1 series the only setting permitted is 230Veff [0].
0x2540:002 (P208.02)	Mains settings: Undervoltage warning threshold (Mains setting: LU warn. thresh.) 0 ... [0]* ... 800 V *Default settings depending on the size.	Setting of the warning threshold for monitoring DC bus undervoltage. – If the DC bus voltage falls below the threshold set, the variable speed drive outputs a warning. – The warning is reset with a hysteresis of 10 V.
0x2540:003 (P208.03)	Mains settings: Undervoltage error threshold (Mains settings: LU error thresh.) – Read only: x V	Display of the fixed error threshold for monitoring DC bus undervoltage. – If the DC-bus voltage falls below the threshold displayed, the "Fault" response is triggered.
0x2540:004 (P208.04)	Mains settings: Undervoltage reset threshold (Mains settings: LU reset thresh.) – Read only: x V	Display of the fixed reset threshold for monitoring DC bus undervoltage.
0x2540:005 (P208.05)	Mains settings: Overvoltage warning threshold (Mains settings: OU warn. thresh.) 0 ... [0]* ... 800 V *Default setting depending on the size.	Setting of the warning threshold for monitoring DC bus overvoltage. – If the DC bus voltage exceeds the threshold set, the inverter outputs a warning. – The warning is reset with a hysteresis of 10 V.
0x2540:006 (P208.06)	Mains settings: Overvoltage error threshold (Mains settings: OU error thresh.) – Read only: x V	Display of the fixed error threshold for monitoring the DC bus overvoltage. – If the DC-bus voltage exceeds the threshold displayed, the "Fault" response is triggered.
0x2540:007 (P208.07)	Mains settings: Overvoltage reset threshold (Mains settings: OU reset thresh.) – Read only: x V	Display of the fixed reset threshold for monitoring DC bus overvoltage.

## 7.2 CONTROL SOURCE SELECTION

The selected "control source" serves to provide the variable speed drive with its start, stop, and reversal commands.

Possible control sources are:



- Digital inputs
- Keypad

**i** Irrespective of the control source selection, stop commands are always active from each source connected!  
Exception: In the jog operation, a stop command has no impact.

1565 GB 09 18

### Details

- The default setting "Flexible I/O configuration [0]" in 0x2824 (P200.00) enables a flexible control of the variable speed drive via digital inputs and keypad. The control of the variable speed drive via the digital inputs is preconfigured. For details see the chapter "Function assignment of the inputs and outputs".
- If the keypad is to be used as the sole control source for the application, selection "Keypad [1]" is to be set in 0x2824 (P200.00).
- The control source that is currently active is displayed in 0x282B:001 (P125.01).

Parameter	Name / value range / [default setting]	Info
0x2824 (P200.00)	Control selection (Control select.)	Selection of the type of variable speed drive control.
	0 Flexible I/O configuration	This selection enables a flexible assignment of the start, stop, and rotating direction commands with digital signal sources. - Digital signal sources can be digital inputs and keypad. - The I/O configuration is made via the parameters 0x2631:xx (P400.xx).
	1 Keypad	This selection enables the motor to be started exclusively via the start key of the keypad. Other signal sources for starting the motor are ignored.  Start motor  Stop motor  Note! - The function "Enable inverter" 0x2631:001 (P400.01) and "Run" 0x2631:002 (P400.02) must be set to TRUE to start the motor. - If jog operation is active the motor cannot be stopped via the  keypad key.
0x282B:001 (P125.01)	Active control source	Display of the control source that is currently active
	- Read only	
	0 Flexible I/O configuration	
	2 Keypad	
	8 Keypad full control	

### Related topics

- The preset I/O configuration can be individually adapted to the respective application.  
For details see the chapter "Flexible I/O configuration".

### 7.3 SELECTION OF SETPOINT SOURCE

The selected "setpoint source" serves to provide the variable speed drive with its setpoint. The setpoint source can be selected individually for each operating mode.

Possible setpoint sources are:

- Analog inputs
- Keypad
- Parameterisable setpoints (presets)
- "Motor potentiometer" function
- "Sequencer" function

#### Details

- For applications only requiring one setpoint it is sufficient to define the standard setpoint source in the following parameters.
- For applications requiring a change-over of the setpoint source during operation, the functions for setpoint change-over have to be configured accordingly.
- See chapter "Setpoint change-over".

1585 GB 09 18

Parameter	Name / value range / [default setting]	Info
0x2860:001 (P201.01)	Frequency control: Default setpoint source (Stnd. setpoints: Freq. setp. src.)	Selection of the standard setpoint source for operating mode "MS: Velocity mode". - The selected standard setpoint source is always active in the operating mode 0x6060 (P301.00) = "MS: Velocity mode [-2]" when no setpoint change-over to another setpoint source via corresponding triggers/function is active ► For details see the chapter "Setpoint change-over".
	1 Keypad	The setpoint is specified locally by the keypad. - Default setting: 0x2601:001 (P202.01) - Use the <b>↑</b> and <b>↓</b> navigation keys to change the keypad setpoint (also during running operation)
	2 Analog input 1	The setpoint is defined as analog signal via the analog input 1. ► For details see the chapter "Analog input 1".
	3 Analog input 2	The setpoint is defined as analog signal via the analog input 2. ► For details see the chapter "Analog input 2".
	5 Network	The setpoint is defined as process data object via the network. Note. This function is not available for VLA1.
	11 Frequency preset 1	For the setpoint selection, preset values can be parameterised and selected. ► For details see the chapter "Setpoint source of preset setpoints".
	12 Frequency preset 2	
	13 Frequency preset 3	
	14 Frequency preset 4	
	15 Frequency preset 5	
	16 Frequency preset 6	
	17 Frequency preset 7	
	18 Frequency preset 8	
	19 Frequency preset 9	
	20 Frequency preset 10	
	21 Frequency preset 11	
	22 Frequency preset 12	
	23 Frequency preset 13	
	24 Frequency preset 14	
	25 Frequency preset 15	
	31 Segment preset 1	For the setpoint selection, the segment presets parameterised for the "sequencer" function can be selected as well. ► For details see the chapter "Sequencer".
	32 Segment preset 2	
	33 Segment preset 3	
	34 Segment preset 4	
	35 Segment preset 5	
	36 Segment preset 6	
37 Segment preset 7		
38 Segment preset 8		
50 Motor potentiometer	The setpoint is generated by the "motor potentiometer" function. This function can be used as an alternative setpoint control which is controlled via two signals: "MOP setpoint up" and "MOP setpoint down". ► For details see the chapter "Motor potentiometer setpoint source (MOP)".	
201 Internal value	Internal values of the manufacturer.	
202 Internal value		
203 Internal value		
204 Internal value		
205 Internal value		
206 Internal value		

Parameter	Name / value range / [default setting]	Info
0x2860:002 (P201.02)	PID control: Default setpoint source (Std. setpoints: PID setp. src.)	Selection of the standard setpoint source for the reference value of the PID control. – The selected standard setpoint source is always active with an activated PID control when no setpoint change-over to another setpoint source via corresponding triggers/functions is active.
	<b>1 Keypad</b>	The setpoint is specified locally by the keypad. – Default setting: 0x2601:002 (P202.02) – Use the <b>↑</b> and <b>↓</b> navigation keys to change the keypad setpoint (also during running operation)
	2 Analog input 1	The setpoint is defined as analog signal via the analog input 1. ► For details see the chapter "Analog input 1".
	3 Analog input 2	The setpoint is defined as analog signal via the analog input 2. ► For details see the chapter "Analog input 2".
	5 Network	The setpoint is defined as process data object via the network. Note. This function is not available for VLA1.
	11 PID preset 1	For the setpoint selection, preset values can be parameterised and selected. ► For details see the chapter "Setpoint source of preset setpoints".
	12 PID preset 2	
	13 PID preset 3	
	14 PID preset 4	
	15 PID preset 5	
	16 PID preset 6	
	17 PID preset 7	
	18 PID preset 8	
	31 Segment preset 1	For the setpoint selection, the segment presets parameterised for the "sequencer" function can be selected as well. ► For details see the chapter "Sequencer".
	32 Segment preset 2	
	33 Segment preset 3	
	34 Segment preset 4	
	35 Segment preset 5	
	36 Segment preset 6	
	37 Segment preset 7	
38 Segment preset 8		
50 Motor potentiometer	The setpoint is generated by the "motor potentiometer" function. This function can be used as an alternative setpoint control which is controlled via two signals: "MOP setpoint up" and "MOP setpoint down". ► For details see the chapter "Motor potentiometer setpoint source (MOP)".	
201 Internal value	Internal values of the manufacturer.	
202 Internal value		
203 Internal value		
204 Internal value		
205 Internal value		
206 Internal value		

Parameter	Name / value range / [default setting]	Info
0x2860:003 (P201.03)	Torque control: Default setpoint source (Std. setpoints: Torque setp.src.)	Selection of the standard setpoint source for operating mode "MS: Torque mode". – The selected standard setpoint source is always active in the operatin mode 0x6060 (P301.00) = "MS: Torque mode [-1]" when no setpoint change-over to another setpoint source via corresponding triggers/ functions is active.
	1 Keypad	The setpoint is specified locally by the keypad. – Default setting: 0x2601:003 (P202.03) – Use the <b>↑</b> and <b>↓</b> navigation keys to change the keypad setpoint (also during running operation)
	2 <b>Analog input 1</b>	The setpoint is defined as analog signal via the analog input 1. ► For details see the chapter "Analog input 1".
	3 Analog input 2	The setpoint is defined as analog signal via the analog input 2. ► For details see the chapter "Analog input 2".
	5 Network	The setpoint is defined as process data object via the network. Note. This function is not available for VLA1.
	11 Torque preset 1	For the setpoint selection, preset values can be parameterised and selected. ► For details see the chapter "Setpoint source of preset setpoints".
	12 Torque preset 2	
	13 Torque preset 3	
	14 Torque preset 4	
	15 Torque preset 5	
	16 Torque preset 6	
	17 Torque preset 7	
	18 Torque preset 8	
	31 Segment preset 1	For the setpoint selection, the segment presets parameterised for the "sequencer" function can be selected as well. ► For details see the chapter "Sequencer".
	32 Segment preset 2	
	33 Segment preset 3	
	34 Segment preset 4	
	35 Segment preset 5	
	36 Segment preset 6	
	37 Segment preset 7	
38 Segment preset 8		
50 Motor potentiometer	The setpoint is generated by the "motor potentiometer" function. This function can be used as an alternative setpoint control which is controlled via two signals: "MOP setpoint up" and "MOP setpoint down". ► For details see the chapter "Motor potentiometer setpoint source (MOP)".	
201 Internal value	Internal values of the manufacturer.	
202 Internal value		
203 Internal value		
204 Internal value		
205 Internal value		
206 Internal value		

### 7.3.1 KEYPAD SETPOINT DEFAULT SETTINGS

For the manual setpoint selection via keypad the following default settings are used.

Parameter	Name / value range / [default setting]	Info
0x2601:001 (P202.01)	Keypad setpoints: Frequency setpoint (Keypad setpoints: KP freq.setpoint) 0.0 ... [20.0] ... 599.0 Hz	Default setting of the keypad setpoint for the operating mode 0x6060 (P301.00) = "MS: Velocity mode [-2]".
0x2601:002 (P202.02)	Keypad setpoints: Process controller setpoint (Keypad setpoints: KP PID setpoint) -300.00 ... [0.00] ... 300.00 PID unit	Default setting of the keypad setpoint for the reference value of the PID control.
0x2601:003 (P202.03)	Keypad setpoints: Torque setpoint (Keypad setpoints: KP torq.setpoint) -400.0 ... [100.0] ... 400.0 %	Default setting of the keypad setpoint for the operating mode 0x6060 (P301.00) = "MS: Torque mode [-1]". – 100 % ≡ Motor rated torque 0x6076 (P325.00)

The increment for keypad setpoints can be adapted in 0x2862 (P701.00) by pressing a keypad arrow key once.

7.4.1 STARTING PERFORMANCE

The start can be optionally made with DC braking or flying restart circuit. Moreover, an automatic start can be activated after switch-on.

Details

The start method can be selected in 0x2838:001 (P203.01). The following diagram demonstrates the different start methods:

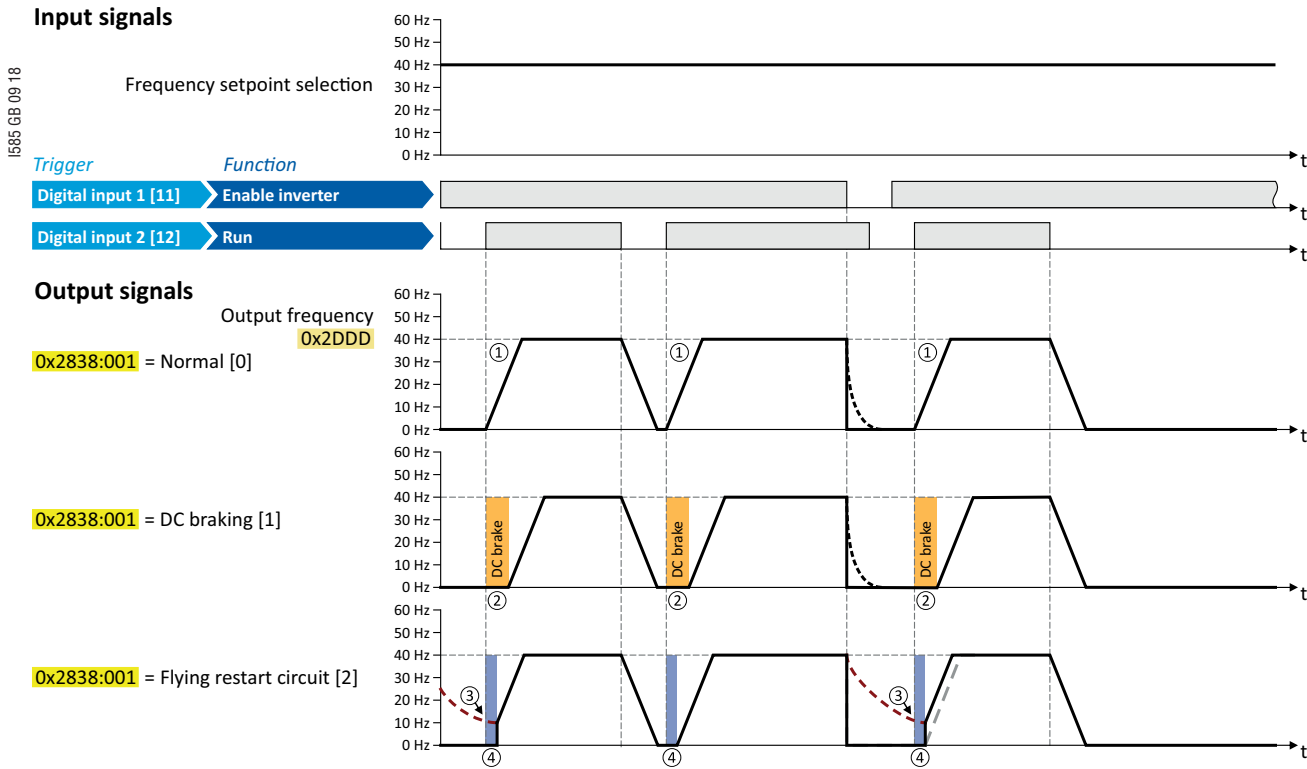

- ① Start method = "Normal [0]": After the start command, the motor is accelerated to the setpoint with the set acceleration time
- ② Start method = "DC braking [1]": After the start command, the "DC braking" function is active. Only after the hold time set in 0x2B84:002 (P704.02) has elapsed, the motor is accelerated to the setpoint with the set acceleration time.  
► For details see chapter "DC braking".
- ③ For demonstrating the flying restart circuit: At the time of the start command, the motor is not at standstill (for instance by loads with high inertia such as fans or flywheels)
- ④ Start method = "Flying restart circuit [2]": After the start command, the flying restart circuit is active. The flying restart circuit serves to restart a coasting motor on the fly during operation without speed feedback. The synchronicity between variable speed drive and motor is coordinated so that the transition to the rotating motor is effected without jerk at the time of connection. ①

### Automatic start after switching on the mains voltage

The automatic start can be activated in 0x2838:002 (P203.02). Preconditions for the automatic start:

- Flexible I/O configuration is selected: 0x2824 (P200.00) = "Flexible I/O configuratin [0]"
- For the start command, a digital input has been configured (In case of keypad or activated network control, an automatic start is not possible.)

The following diagram demonstrates the function:

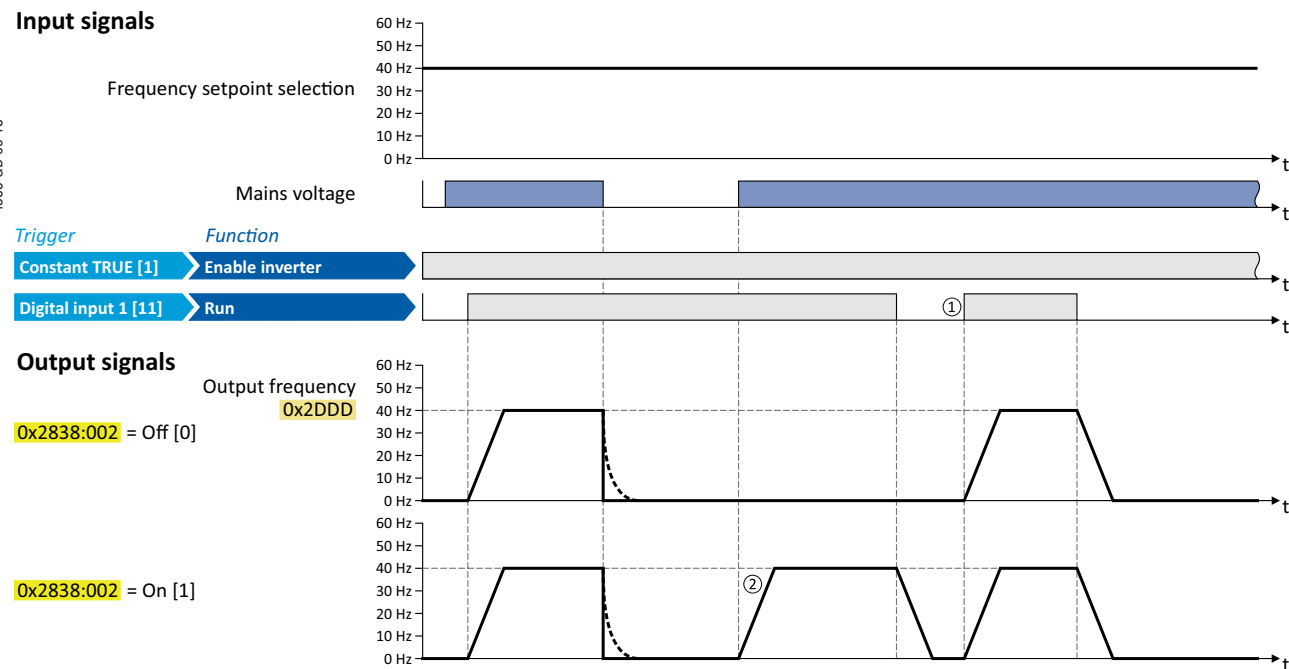

- ① Start at power-up = "Off [0]": After switching on the mains voltage, a renewed start command is required to start the motor.  
 ② Start at power-up = "On [1]": After switching on the mains voltage, the motor starts automatically if a start command is active.

Parameter	Name / value range / [default setting]	Info
0x2838:001 (P203.01)	Start/stop configuration: Start method (Start/stop cfg: Start method) - Setti can only be changed if the inverter is inhibited.	Behaviour after start command.
	0 Normal	After start command, the standard ramps are active - Acceleration time 1 can be set in 0x2917 (P220.00). - Deceleration time 1 can be set in 0x2918 (P221.00).
	1 DC braking	After start command, the "DC braking" function is active for the time set in 0x2B84:002 (P704.02). ► For details see chapter "DC braking".
	2 Flying restart circuit	After the start command, the flying restart circuit is active The flying restart function makes it possible to restart a coasting motor during operation without speed feedback. Synchronicity between the variable speed drive and motor is coordinated so that the transition to the rotating motor is effected without jerk at the time of connection. ► For details see chapter "Flying restart circuit".
	3 For future use	
0x2838:002 (P203.02)	Start/stop configuration: Start at power-up (Start/stop cfg: Start at powerup)	Starting performance after switching on the mains voltage.
	0 Off	No automatic start after switching on mains voltage. In addition to the inverter enable, a renewed start command is always required to start the motor.
	1 On	Automatic start of the motor after switching on the mains voltage if the variable speed drive is enabled and a start command exists.

## 7.4.2 STOPPING PERFORMANCE

In the default setting, the motor is brought to a standstill after a stop command with standard ramp. Alternatively coasting or ramping down with quick stop ramp can be selected.

### Details

The stop method can be selected in 0x2838:003 (P203.03). The following diagram demonstrates the different stop methods:

### Input signals

1585 GB 09 18

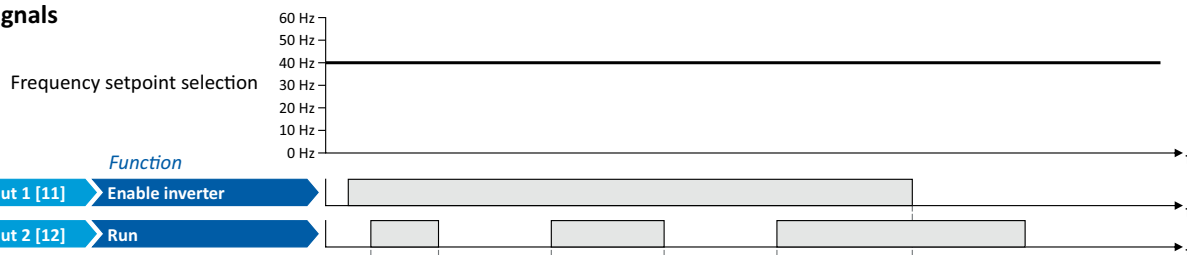

### Output signals

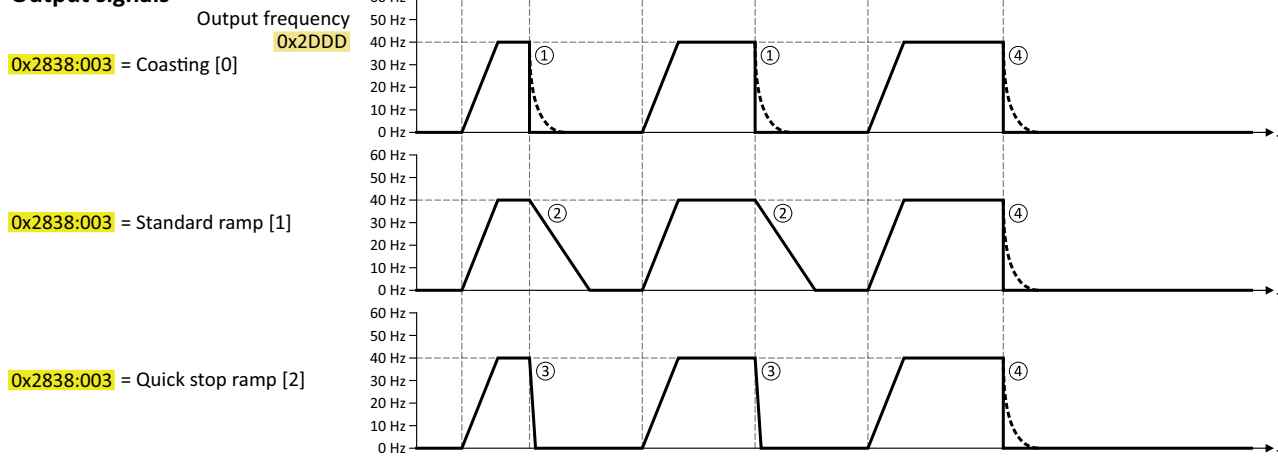

- ① Stop method = "Coasting [0]": The motor is coasting.
- ② Stop method = "Standard ramp [1]": The motor is brought to standstill with a deceleration time 1 (here: 10 s).
- ③ Stop method = "Quick stop ramp [2]": The motor is brought to a standstill with the deceleration time for quick stop (here: 1 s).
- ④ If "Enable inverter" is set to FALSE, the drive is disabled. The motor becomes torqueless and coasts to standstill depending on the mass inertia of the machine (irrespective of the set stop method).

Parameter	Name / value range / [default setting]	Info
0x2838:003 (P203.03)	Start/stop configuration: Stop method (Start/stop cfg: Stop method)	Behaviour after the "Stop" command.
	0 Coasting	The motor becomes torqueless (coasts down to standstill)
	1 Standard ramp	The motor is brought to a standstill with deceleration time 1 (or deceleration time 2, if activated) – Deceleration time 1 can be set in 0x2918 (P221.00). – Deceleration time 2 can be set in 0x291A (P223.00). ► Frequency limits and ramp time
2 Quick stop ramp	The motor is brought to a standstill with the deceleration time set for the "Quick stop" function. – Deceleration time for quick stop can be set in 0x291C (P225.00). – The "quick stop" function can also be activated manually, for instance via a digital input. ► Quick stop	



## 7.5 FREQUENCY LIMITS AND RAMP TIME

The frequency range can be limited by setting a minimum and maximum frequency. For the frequency setpoint, two different ramps can be parameterised. Change-over to ramp 2 can be carried out manually or automatically.

### Details

The frequency setpoint is internally led via a ramp generator.

- The acceleration time set in 0x2917 (P220.00) refers to an acceleration from standstill to the maximum frequency set in 0x2916 (P211.00). At a low setpoint selection the real acceleration time decreases accordingly.
- The deceleration time set in 0x2918 (P221.00) refers to the deceleration of the set maximum frequency to standstill. In case of a lower actual frequency, the actual deceleration time is reduced accordingly.

1585 GB 09 18

### Input signals

Frequency setpoint selection

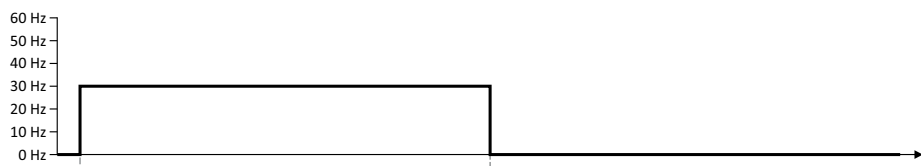

### Output signals

Output frequency

0x2DDD

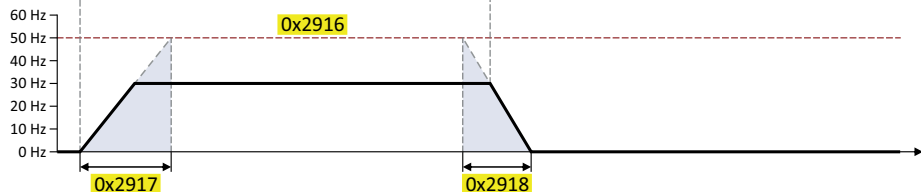

Automatic/manual change-over to ramp 2

- For ramp 2, the acceleration time 2 set in 0x2919 (P222.00) and the deceleration time 2 set in 0x291A (P223.00) apply.
- The change-over to ramp 2 is effected automatically if the frequency setpoint (absolute value)  $\geq$  auto-changeover threshold 0x291B (P224.00).

### Input signals

Frequency setpoint selection

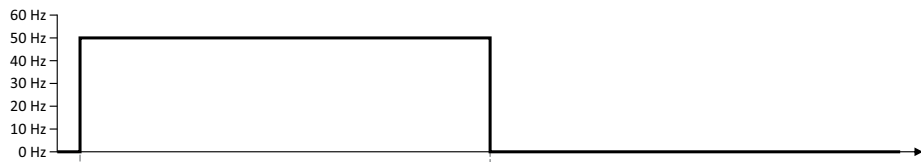

### Output signals

Output frequency

0x2DDD

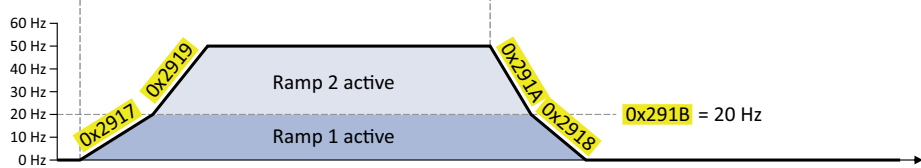

- The "Activate ramp 2" function serves to manually activate the acceleration time 2 and the deceleration time 2.

► For details see chapter "Activating ramp 2 manually".

Parameter	Name / value range / [default setting]	Info
0x2915 (P210.00)	Minimum frequency (Min. frequency) 0.0 ... [0.0] ... 599.0 Hz	Lower limit value for all frequency setpoints.
0x2916 (P211.00)	Maximum frequency (Max. frequency) Device for 50-Hz mains: 0.0 ... [50.0] ... 599.0 Hz Device for 60-Hz mains: 0.0 ... [60.0] ... 599.0 Hz	Upper limit value for all frequency setpoints.
0x2917 (P220.00)	Acceleration time 1 (Accelerat.time 1) 0.0 ... [5.0] ... 3600.0 s	Acceleration time 1 for the operating mode "MS: Velocity mode". – The acceleration time set refers to the acceleration from standstill to the maximum frequency set. In the case of a lower setpoint selection the actual acceleration time is reduced accordingly.
0x2918 (P221.00)	Deceleration time 1 (Decelerat.time 1) 0.0 ... [5.0] ... 3600.0 s	Deceleration time 1 for the operating mode "MS: Velocity mode". – The deceleration time set refers to the deceleration from the maximum frequency set to standstill. In the case of a lower actual frequency, the actual deceleration time is reduced accordingly.
0x2919 (P222.00)	Acceleration time 2 (Accelerat.time 2) 0.0 ... [5.0] ... 3600.0 s	Acceleration time 2 for the operating mode "MS: Velocity mode". – The acceleration time set refers to the acceleration from standstill to the maximum frequency set. In the case of a lower setpoint selection the actual acceleration time is reduced accordingly. – The acceleration time 2 is active if the frequency setpoint (absolute value) $\geq$ auto switching threshold 0x291B (P224.00) or the trigger assigned to the function "Activat ramp 2" in 0x2631:039 (P400.39) = TRUE. – The acceleration time 2 is also used for changing the MOP setpoint generated by the "motor potentiometer" function.
0x291A (P223.00)	Deceleration time 2 (Decelerat.time 2) 0.0 ... [5.0] ... 3600.0 s	Deceleration time 2 for the operating mode "MS: Velocity mode". – The deceleration time set refers to the deceleration from the maximum frequency set to standstill. In the case of a lower actual frequency, the actual deceleration time is reduced accordingly. – The deceleration time 2 is active if the frequency setpoint (absolute value) $\geq$ auto change-over threshold 0x291B (P224.00) or the trigger assigned to the function "Activat ramp 2" in 0x2631:039 (P400.39) = TRUE.
0x291B (P224.00)	Auto-changeover threshold of ramp 2 (Ramp 2 thresh.) 0.0 ... [0.0] ... 599.0 Hz	Threshold for the automatic change-over to acceleration time 2 and deceleration time 2. – The change-over is effected if the frequency setpoint (absolute value) $\geq$ auto change-over threshold. – With the setting 0, the automatic change-over function is deactivated

Example for operating mode

Parameter	Name	Setting for this example
0x2631:001 (P400.01)	Enable inverter	Constant TRUE [1]
0x2631:002 (P400.02)	Run	Digital input 1 [11]
0x2915 (P210.00)	Minimum frequency	15 Hz
0x2916 (P211.00)	Maximum frequency	40 Hz
0x2917 (P220.00)	Acceleration time 1	4 s
0x2918 (P221.00)	Deceleration time 1	3 s

1585 GB 09 18

Input signals

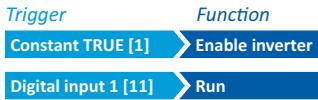
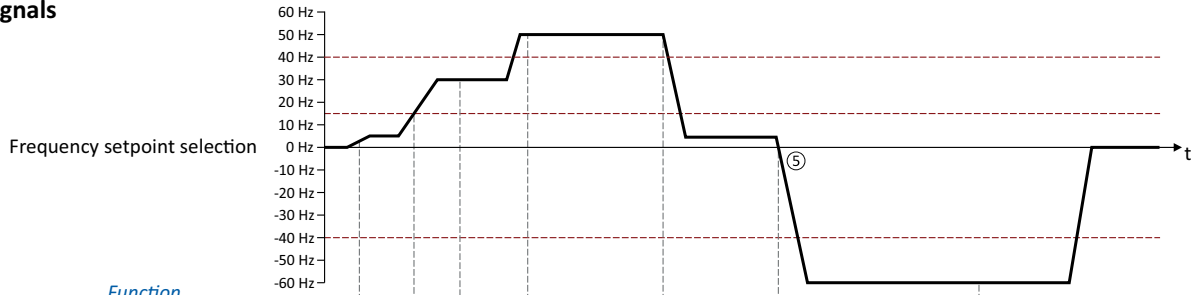

Output signals

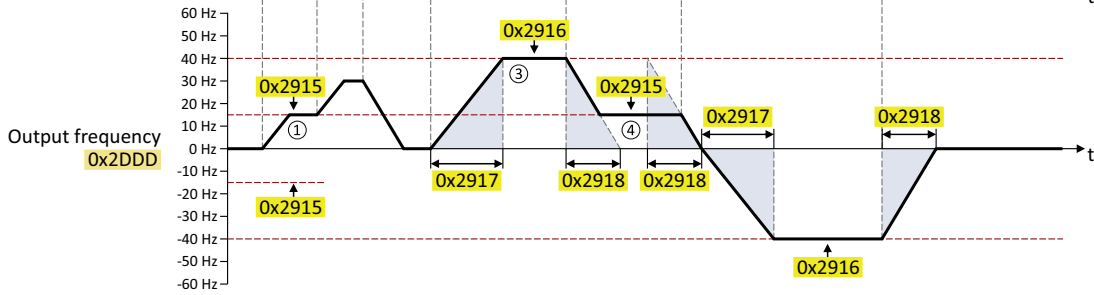

- ① After a start command, the motor is accelerated to the minimum frequency. This is also the case if the setpoint selection is = 0 Hz. If the setpoint exceeds the minimum frequency, the ramp generator follows the setpoint.
- ② If the start command is deactivated again, the motor is stopped with the stop method set in 0x2838:003 (P203.03) (here: Standard ramp).
- ③ The motor is accelerated to the set maximum frequency.
- ④ If the setpoint falls below the minimum frequency, it is decelerated up to the minimum frequency.
- ⑤ In case of a sign reversal of the setpoint, a change of direction of rotation takes place, minimum and maximum frequency, however, continue to apply.

## 7.6 QUICK STOP

The "quick stop" function is an alternative stop method if the motor has to be stopped faster than normal.

**i** Cancelling the quick stop causes a restart of the motor if the start command is still active and the variable speed drive is enabled!

### Details

– Possible triggers to be selected for the "quick stop" function are available for example in 0x2631:003 (P400.03) the digital inputs and internal status signals of the variable speed drive.

### Diagnostic parameters:

– 0x282A:002 (P126.02) displays the cause of quick stop bit-coded.

1585 GB 09 18

Parameter	Name / value range / [default setting]	Info
0x291C (P225.00)	Quick stop deceleration time (QSP dec. time) 0.0 ... [1.0] ... 3600.0 s	Quick stop deceleration time for the operating mode "MS: Velocity mode". – If the "Quick stop" function is activated the motor is brought to a standstill within the deceleration time set here. – The deceleration time set refers to the deceleration from the maximum frequency set to standstill. In the case of a lower actual frequency, the actual deceleration time is reduced accordingly.
0x2631:003 (P400.03)	Function list: Activate quick stop (Function list: Quick stop) – Setting can only be changed if the variable speed drive is inhibited. – For further possible settings see parameter 0x2631:001 (P400.01).	Assignment of a trigger for the "Activate quick stop" function Trigger = TRUE: Activate quick stop. Trigger = FALSE: Deactivate quick stop.  Notes: – The "Quick stop" function brings the motor to a standstill within the deceleration time set in 0x291C (P225.00).
	<b>0 Not connected</b>	

### Example for operating mode

Parameter	Name	Setting for this example
0x2631:001 (P400.01)	Enable inverter	Constant TRUE [1]
0x2631:002 (P400.02)	Run	Digital input 1 [11]
0x2631:003 (P400.03)	Activat quick stop	Digital input 2 [12]
0x2838:003 (P203.03)	Stop method	Standard ramp [1]
0x2916 (P211.00)	Maximum frequency	50 Hz
0x2917 (P220.00)	Acceleration time 1	4 s
0x2918 (P221.00)	Deceleration time 1	3 s
0x291C (P225.00)	Quick stop deceleration time	1 s

### Input signals

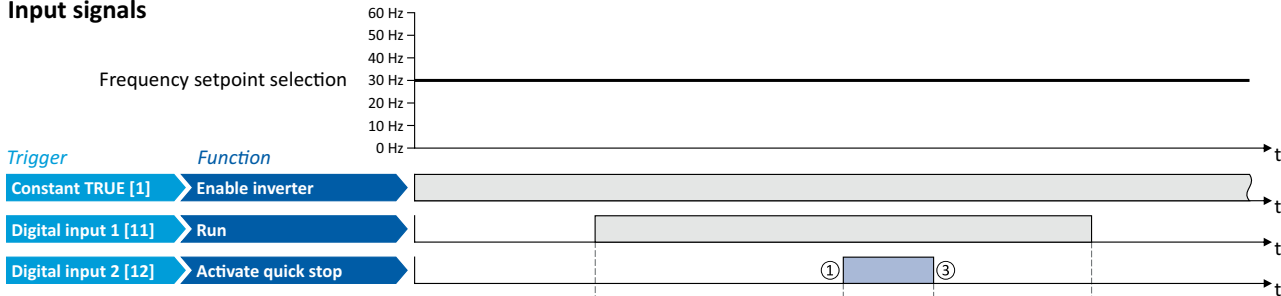

### Output signals

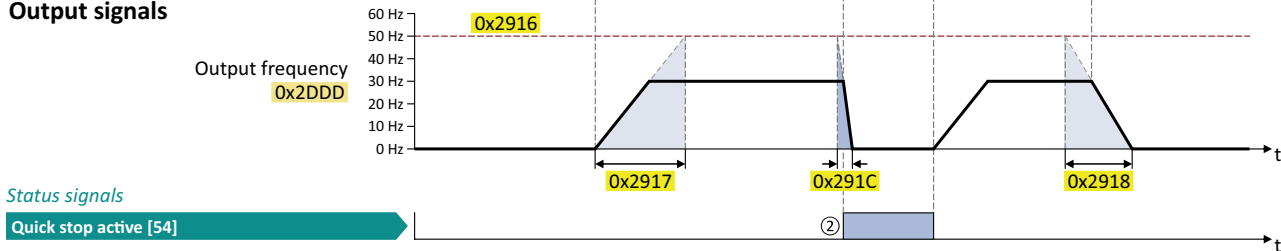

- ① Quick stop is activated. The motor is brought to a standstill within the deceleration time set in 0x291C (P225.00).
- ② If quick stop is active, the status signal "Quick stop active[54]" is set to TRUE. This status signal can be assigned via the Flexible I/O configuration of a function or a digital output.
- ③ Quick stop is deactivated again: The motor accelerates again to the setpoint since the start command is still active.

## 7.8 OPTICAL DEVICE IDENTIFICATION

For applications including several variable speed drives it may be difficult to locate a device that has been connected online. The "Optical device identification" function serves to locate the variable speed drive by means of blinking LEDs.

### Details

In order to start the visual tracking,

- click the button in the toolbar of the VLBXSW or
- set 0x2021:001 (P230.01) = "Start [1]".

After the start, both LEDs "RDY" and "ERR" on the front of the variable speed drive synchronously blink very fast.

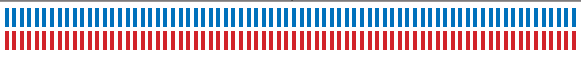
1585 GB 09 18	"RDY" LED (blue)	"ERR" LED (red)	Status/meaning
	 <p>Both LEDs are blinking in a very rapidly synchronous mode</p>		"Visual tracking" function is active.

The blinking duration can be set in 0x2021:002 (P230.02) or selected in the VLBX SW in the dropdown list field:

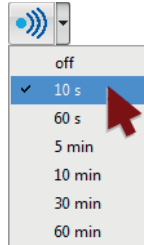

Parameter	Name / value range / [default setting]	Info
0x2021:001 (P230.01)	Optical tracking: Start detection (Optical tracking: Start detection)	1 = start optical device identification – After the start, the two LEDs "RDY" and "ERR" on the front of the variable speed drive are blinking with a blinking frequency of 20 Hz for the blinking duration set in 0x2021:002 (P230.02). The setting is then automatically reset to "0" again. – If the function is reactivated within the blinking time set, the time is extended correspondingly. – A manual reset to "0" makes it possible to stop the function prematurely.
	<b>0</b> Stop	
	1 Start	

## 8 MOTOR CONTROL

This chapter contains all functions and settings relevant for the motor control.

Basic procedure of commissioning the motor control.

In the first step, the rated data of the motor must be set. The other steps depend on the respective application case.

There are several options for setting the motor data and optimising the control loops. Basically, you can select between a manual and an automatic process. Whether a setting can be applied or not depends on the motor and the application. If possible, always use the possible setting listed first in the following diagram since this one leads to the most accurate results.

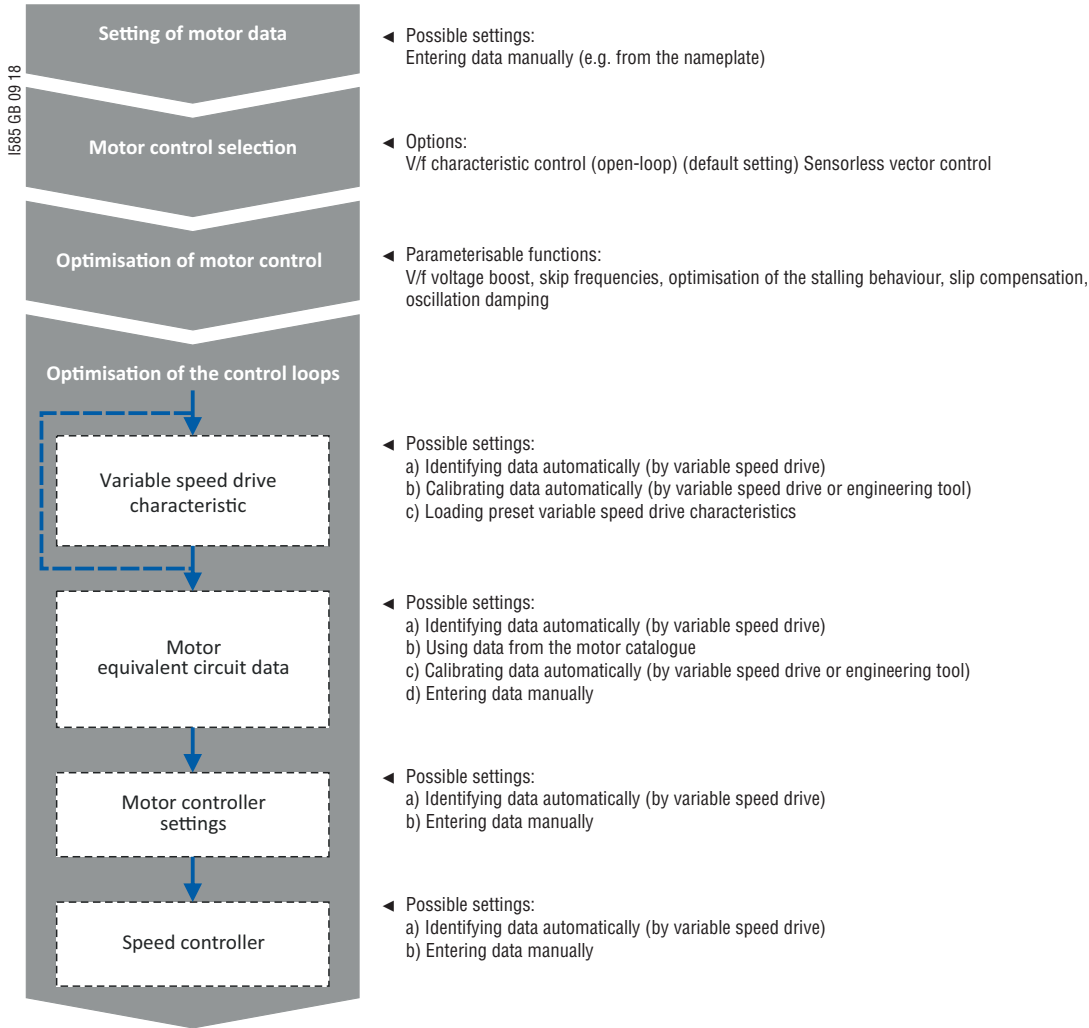

The term "motor data" comprises all parameters only depending on the motor and only characterising the electrical behaviour of the machine. Motor data are independent of the application in which the variable speed drive and the motor are used.

#### Precondition

When you enter the motor nameplate data, take into account the phase connection implemented for the motor (star or delta connection). Only enter the data applying to the connection type selected.

#### 8.1.1 MANUAL SETTING OF THE MOTOR DATA

The motor data must be set manually in the following parameters according to the manufacturer information/motor data sheet.

Parameter	Name / value range / [default setting]	Info
0x2C01:001	Motor parameters: Number of pole pairs – Read only	Display of the number of pole pairs calculated from the rated speed and rated frequency.
0x2C01:004 (P320.04)	Motor parameters: Rated speed (Motor parameters: Rated speed) Device for 50-Hz mains: 50 ... [1450] ... 50000 rpm Device for 60-Hz mains: 50 ... [1750] ... 50000 rpm	General motor data. Carry out settings as specified by motor nameplate data.  <b>Note!</b> When you enter the motor nameplate data, take into account the phase connection implemented for the motor (star or delta connection) Only enter the data applying to the connection type selected.
0x2C01:005 (P320.05)	Motor parameters: Rated frequency (Motor parameters: Rated frequency) Device for 50-Hz mains: 1.0 ... [50.0] ... 1000.0 Hz Device for 60-Hz mains: 1.0 ... [60.0] ... 1000.0 Hz	
0x2C01:006 (P320.06)	Motor parameters: Rated power (Motor parameters: Rated power) 0.00 ... [0.25]* ... 655.35 kW *Default setting depending on the size.	
0x2C01:007 (P320.07)	Motor parameters: Rated voltage (Motor parameters: Rated voltage) 0 ... [230]* ... 65535 V *Default setting depending on the size.	
0x2C01:008 (P320.08)	Motor parameters: Cosine phi (Motor parameters: Cosine phi) 0.00 ... [0.80] ... 1.00	
0x6075 (P323.00)	Motor rated current (Motor current) 0.001 ... [1.700]* ... 500.000 A *Default setting depending on the size. – Setting can only be changed if the variable speed drive is inhibited.	The rated motor current to be set here serves as a reference value for different parameters with a setting/display of a current value in percent. Example: – Motor rated current = 1.7 A – Max current 0x6073 (P324.00) = 200 % Motor rated current = 3.4 A
0x6076 (P325.00)	Motor rated torque (Motor torque) 0.001 ... [1.650]* ... 4294967.295 Nm *Default setting depending on the size. – Setting can only be changed if the variable speed drive is inhibited.	The rated motor torque to be set here serves as a reference value for different parameters with a setting/display of a torque value in percent. Example: – Motor rated torque = 1.65 Nm – Max torque 0x6072 (P326.00) = 250 % Motor rated torque = 4.125 Nm
0x6080 (P322.00)	Max motor speed (Max motor speed) 0 ... [6075] ... 480000 rpm	Limitation of the maximum motor speed.

The variable speed drive supports different modes for closed-loop/open-loop motor control.

Parameter	Name / value range / [default setting]	Info
0x2C00 (P300.00)	Motor control mode (Motor ctrl mode) – Setting can only be changed if the variable speed drive is inhibited.	Selection of the motor control type.
	4 Sensorless vector control (SLVC)	This control type is used for sensorless vector control of an asynchronous motor. ► For details see chapter "Sensorless vector control (SLVC)".
	6 <b>V/f characteristic control (VFC open loop)</b>	This control mode is used for the speed control of an asynchronous motor via a V/f characteristic and is the simplest control mode. ► For details see chapter "V/f characteristic control (VFC)".

In the following subchapters, each motor control is described in detail.

### 8.2.1 V/F CHARACTERISTIC CONTROL (VFC)

The V/f characteristic control is a motor control for conventional frequency inverter applications. It is based on a simple and robust control mode for the operation of asynchronous motors with a linear or square-law load torque characteristic (e.g. fan). Because of the minimal parameterisation effort, such applications can be commissioned easily and quickly.

#### Precondition

- The V/f characteristic control is only suitable for asynchronous motors.
- If you want to actuate a drive with a square-law V/f characteristic please always check whether the corresponding drive is suitable for operation with a square-law V/f characteristic!
- From the motor nameplate data, at least the rated speed and rated frequency must be entered, so that the variable speed drive can calculate the correct number of pole pairs.  
► For details see chapter "Motor data".
- The motor must only be actuated above the rated motor frequency/rated voltage if this is expressly approved by the motor manufacturer!

#### Details

This motor control type is activated by setting 0x2C00 (P300.00) = " V/f characteristic control (VFC open loop) [6]".

- 0x2B00 (P302.00) provides different characteristic shapes which are described in detail in the following subchapters.
- Limiting factors for the V/f characteristic are rated mains voltage 0x2540:001 (P208.01), minimum frequency 0x2915 (P210.00) and maximum frequency 0x2916 (P211.00).

Parameter	Name / value range / [default setting]	Info
0x2B00 (P302.00)	V/f characteristic shape (V/f charac.shape) – Setting can only be changed if the variable speed drive is inhibited.	Selection of the V/f characteristic shape for the adaptation to different load profiles.
	<b>0 Linear</b>	Linear characteristic for drives with constant load torque over the speed. ► For details see chapter "Linear V/f characteristic".
	1 Quadratic	Square-law characteristic for drives with a linear or square-law load torque over the speed. – Square-law V/f characteristic are preferably used for centrifugal pumps and fan drives. – Please always check whether the corresponding drive is suitable for operation with a square-law V/f characteristic. – If your pump drive or fan drive is not suitable for operation with a square-law V/f characteristic, use the linear V/f characteristic instead. ► For details see chapter "Square-law V/f characteristic".
0x2B01:001 (P303.01)	V/f shape data: Base voltage (V/f shape data: Base voltage) 0 ... [230]* ... 5000 V *Default setting depending on the size.	Base voltage and base frequency define the V/f ratio and thus the gradient of the V/f characteristic. – The V/f base voltage is usually set to the rated motor voltage 0x2C01:007 (P320.07). – The V/f base frequency is usually set to the rated motor frequency 0x2C01:005 (P320.05).
0x2B01:002 (P303.02)	V/f shape data: Base frequency (V/f shape data: Base frequency) Device for 50-Hz mains: 0 ... [50]* ... 1500 Hz Device for 60-Hz mains: 0 ... [60]* ... 1500 Hz *Default setting depending on the size.	

### 8.2.1.1 LINEAR V/F CHARACTERISTIC

The linear V/f characteristic is the most used characteristic shape for general application since they cause a torque that is largely constant.

#### Details

Select V/f characteristic control with linear characteristic

1. Motor control mode 0x2C00 (P300.00) = "V/f characteristic control (VFC open loop) [6]"
2. V/f characteristic shape 0x2B00 (P302.00) = "Linear [0]"

#### Setting of the V/f characteristic

- Limiting factors for the V/f characteristic are rated mains voltage 0x2540:001 (P208.01), minimum frequency 0x2915 (P210.00) and maximum frequency 0x2916 (P211.00).
- The base voltage 0x2B01:001 (P303.01) is usually set to the rated motor voltage (motor nameplate data). The base voltage is preset to the rated mains voltage.
- The base frequency 0x2B01:002 (P303.02) is usually set to the rated motor frequency (motor nameplate data).

1585 GB 09 18

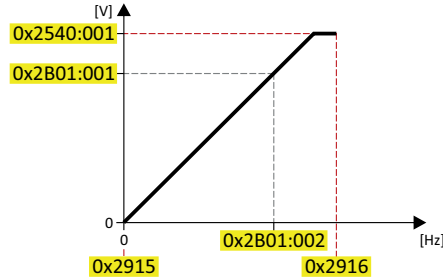

**i** The current output frequency can exceed the set maximum frequency if the gain for the slip compensation in 0x2B09:001 (P315.01) is set to a value higher than 0.

#### Next steps

- The variable speed drive provides different functions by means of which the drive behaviour can be further optimised. For details see chapter "Optimisation of motor control".
- An optimisation of the control loops is not mandatory for this motor control type but may lead to a better control mode. For details see chapter "Optimisation of the control loops".

### 8.2.1.2 SQUARE-LAW V/F CHARACTERISTIC

The square-law V/f characteristic is typically used in heating, ventilation and climate applications to control the speed of fans and pumps.

#### Details

Each application that is provided with the features according to the affinity laws may possibly benefit from a square-law V/f characteristic.

The affinity laws describe the relation between the speed and other variables:

- The volume flow increases proportionately to the speed.
- The required pressure behaves proportionately to the square of the speed.
- The power input is proportionately to the cube of the speed. This means that already a minimal reduction of the speed may lead to substantial savings in energy consumption.

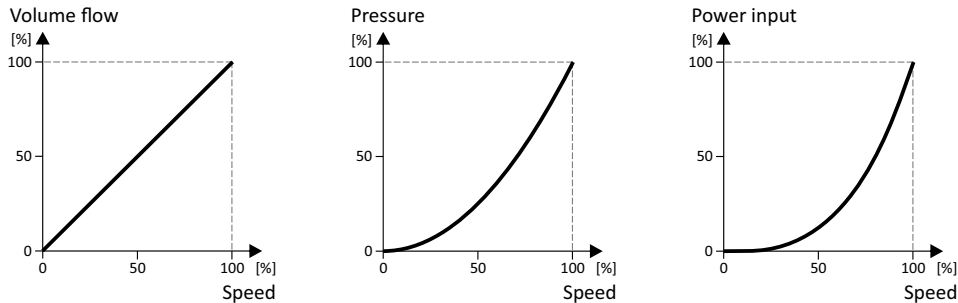

By approximation, the square-law V/f characteristic corresponds to the curve for power input shown above. At low frequencies, the voltage is reduced since due to the type of load a lower voltage is sufficient to generate the required power. All in all, this results in an energy-efficient system.

Select V/f characteristic control with square-law characteristic:

1. Motor control mode 0x2C00 (P300.00) = "V/f characteristic control (VFC open loop) [6]"
2. V/f characteristic shape 0x2B00 (P302.00) = "Quadratic [1]"

#### Setting of the V/f characteristic:

- Limiting factors for the V/f characteristic are rated mains voltage 0x2540:001 (P208.01), minimum frequency 0x2915 (P210.00) and maximum frequency 0x2916 (P211.00).
- The base voltage 0x2B01:001 (P303.01) is usually set to the rated motor voltage (motor nameplate data). The base voltage is preset to the rated mains voltage.
- The base frequency 0x2B01:002 (P303.02) is usually set to the rated motor frequency (motor nameplate data).

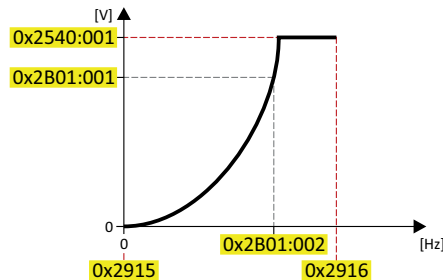

**i** The current output frequency can exceed the set maximum frequency if the gain for the slip compensation in 0x2B09:001 (P315.01) is set to a value higher than 0.

#### Next steps

- The variable speed drive provides different functions by means of which the drive behaviour can be further optimised. ▶ For details see chapter "Optimisation of motor control".
- An optimisation of the control loops is not mandatory for this motor control type but may lead to a better control mode. ▶ For details see chapter "Optimisation of the control loops".



## 8.2.2 SENSORLESS VECTOR CONTROL (SLVC)

Sensorless (field-oriented) vector control for asynchronous motors is based on a decoupled, separate control for the torque-producing and the field-producing current component. In addition, the actual speed is reconstructed by means of a motor model so that a speed sensor is not required.

### Precondition

- Sensorless vector control (SLVC) is only suitable for asynchronous motors.
- The operation of the sensorless vector control (SLVC) is only permitted for a single drive, i. e., only one motor may be connected to the variable speed drive.
- Operation of the sensorless vector control (SLVC) is not permissible for hoists!

### Supported operating modes 0x6060 (P301.00):

- "MS: Velocity mode [-2]"
- "MS: Torque mode [-1]"

### Details

This motor control type is activated by setting 0x2C00 (P300.00) = "Sensorless vector control (SLVC) [4]". Compared to the V/f characteristics the sensorless vector control (SLVC) serves to achieve improved drive characteristics thanks to:

- higher torque throughout the entire speed range
- higher speed accuracy and higher concentricity factor
- higher efficiency

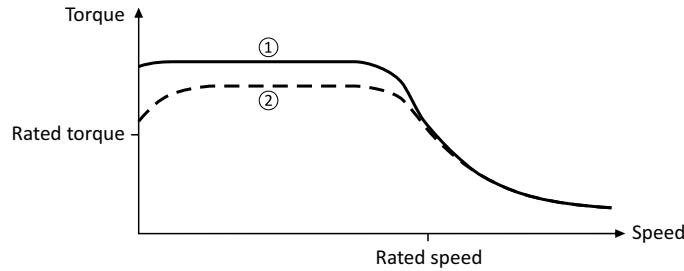

- ① Sensorless vector control (SLVC)
- ② V/f characteristic control (VFC)

For a speed control with torque limitation in operating mode 0x6060 (P301.00) = "MS: Velocity mode [-2]":

1. Select the source in 0x2949:001 (P337.01) for the positive torque limit source and set it accordingly.
2. Select the source in 0x2949:002 (P337.02) for the negative torque limit source and set it accordingly.

Alternatively the variable speed drive can be configured in this motor control type in such a way that it controls a motor torque within a define frequency range.

For details, see chapter "Torque control w/ freq. limit".

Parameter	Name / value range / [default setting]	Info
0x2949:001 (P337.01)	Positive torque limit source (Pos. torqlim src)	Selection of the source for the positive torque limit source.
	0 Max torque	Positive torque limit source = Max torque 0x6072 (P326.00).
	1 Fixed Limit 0.0 %	Positive torque limit source = 0.0 %.
	2 Analog Input 1	The positive torque limit source is defined as analog signal via the analog input 1. ► For details see chapter "Analog input 1".
	3 Analog Input 2	The positive torque limit source is defined as analog signal via the analog input 2. ► For details see chapter "Analog input 2".
	4 Positive torque limit	Positive torque limit source = Positive torque limit 0x60E0.
	5 Network target torque	The positive torque limit source is defined as process data object via network (if available).
0x2949:002 (P337.02)	Negative torque limit source (Neg. torqlim src)	Selection of the source for the negative torque limit source.
	0 (-) Max torque	Negative torque limit source = (-) Max torque 0x6072 (P326.00).
	1 Fixed Limit 0.0 %	Negative torque limit source = 0.0 %.
	2 Analog Input 1	The negative torque limit source is defined as analog signal via the analog input 1. ► For details see chapter "Analog input 1".
	3 Analog Input 2	The negative torque limit source is defined as analog signal via the analog input 2. ► For details see chapter "Analog input 2".
	4 Negative torque limit	Negative torque limit source = Negative torque limit 0x60E1.
	5 Network target torque	The negative torque limit source is defined as process data object via network (if available).
0x2C00 (P300.00)	Motor control mode (Motor ctrl mode) – Settings can only be changed if the variable speed drive is inhibited.	Selection of the motor control type
	4 Sensorless vector control (SLVC)	This control type is used for sensorless vector control of an asynchronous motor. ► For details see chapter "Sensorless vector control (SLVC)".
	6 V/f characteristic control (VFC open loop)	This control mode is used for the speed control of an asynchronous motor via a V/f characteristic and is the simplest control mode. ► For details see chapter "V/f characteristic control (VFC)".
0x6060 (P301.00)	Modes of operation (Modes of op.) – Settings can only be changed if the variable speed drive is inhibited.	Selection of the operating mode.
	-2 MS: Velocity mode	Vendor specific velocity mode
	-1 MS: Torque mode	Vendor specific torque mode – Only possible in motor control type 0x2C00 (P300.00) = "Sensorless vector control (SLVC) [4]". ► For details see chapter "Torque control w/ freq. limit".
	0 No mode change/no mode assigned	No operating mode (standstill).

Setting of motor data → Motor control selection → **Optimisation of motor control** → Optimisation of the control loops

The variable speed drive provides different functions by means of which the drive behaviour can be further optimised.

Function	Motor control type	
	VFC open loop	SLVC
<b>V/f voltage boost</b> The parameterisable voltage boost makes it possible to improve the starting performance for applications requiring a high starting torque.	●	
<b>Skip frequencies</b> By means of the three parameterisable skip frequencies, critical frequencies can be suppressed which lead to mechanical resonances in the system.	●	●
<b>Optimising the stalling behaviour</b> For special motors which enable an operation in the field weakening range, the behaviour in the field weakening range can be adapted to the motor.	●	
<b>Slip compensation</b> In case of a load, the speed of an asynchronous motor decreases. This load-dependent speed drop is called slip. The slip compensation serves to counteract the load-dependent speed loss.	●	
<b>Oscillation damping</b> The oscillation damping serves to reduce the oscillation during no-load operation which are caused by energy oscillating between the mechanical system (mass inertia and the electrical system (DC bus).	●	

1585 GB 09 18

8.3.1 V/F VOLTAGE BOOST

The parameterisable voltage boost makes it possible to improve the starting performance for applications requiring a high starting torque.

Precondition

The function is only effective in the motor control type "V/f characteristic control (VFC open loop)".

Details

- In 0x2B12:001 (P316.01), a permanent voltage boost can be set.
- In 0x2B12:002 (P316.02), an additional voltage boost can be set for acceleration processes only.
- Reference for the percentage setting of the voltage boost is the base voltage 0x2B01:001 (P303.01).

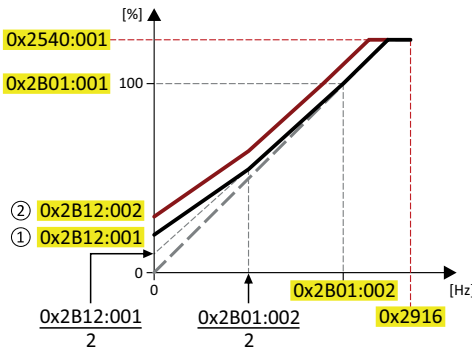

Parameter	Name / value range / [default setting]	Info
0x2B12:001 (P316.01)	Fixed boost (Fixed V/f boost) 0.0 ... [2.5]* ... 20.0 % *Default setting depending on the size.	Fixed (constant) voltage boost for V/f characteristic control without feedback. - 100 % ≡ V/f base voltage 0x2B01:001 (P303.01) - For the purpose of optimising the starting performance for application requiring a high starting torque.
0x2B12:002 (P316.02)	V/f voltage boost: Boost at acceleration (V/f boosts: Dynam. V/f boost) 0.0 ... [0.0] ... 20.0 %	Additional voltage boost for V/f characteristic control without feedback. - 100 % ≡ V/f base voltage 0x2B01:001 (P303.01) - This voltage boost is only active while the motor is accelerated. It acts in addition to the fixed voltage boost set in 0x2B12:001 (P316.01).
0x2B01:001 (P303.01)	V/f shape data: Base voltage (V/f shape data: Base voltage) 0 ... [230]* ... 5000 V *Default setting depending on the size.	Base voltage and base frequency define the V/f ratio and thus the gradient of the V/f characteristic: - The V/f base voltage is usually set to the rated motor voltage 0x2C01:007 (P320.07). - The V/f base frequency is usually set to the rated motor frequency 0x2C01:005 (P320.05).
0x2B01:002 (P303.02)	V/f shape data: Base frequency (V/f shape data: Base frequency) Device for 50-Hz mains: 0 ... [50]* ... 1500 Hz Device for 60-Hz mains: 0 ... [60]* ... 1500 Hz *Default setting depending on the size.	

### 8.3.2 SKIP FREQUENCIES

By means of the three parameterisable skip frequencies, critical frequencies can be suppressed which lead to mechanical resonances in the system.

#### Details

A blocking zone is active as soon as the frequency for this blocking zone is set to value unequal to "0 Hz".

- The set frequency defines the centre of the range to be masked out. ①
- The set bandwidth defines its total size. ②

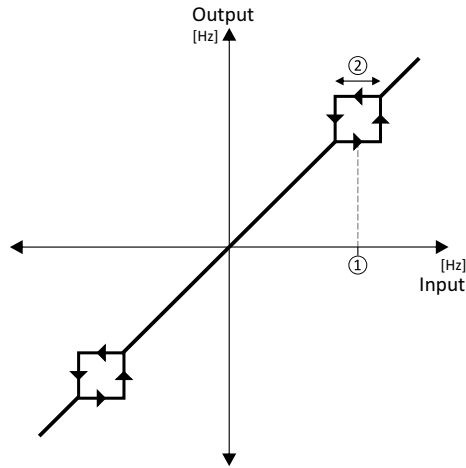

1585 GB 09 18

Example: For a blocking zone, the frequency is set to 20 Hz and the bandwidth to 10 Hz. These settings mask out the range from 15 Hz to 25 Hz.

#### Notes:

- Skip frequencies are absolute values. With the setting "20 Hz", at the same time also the skip frequency "-20 Hz" is defined.
- The variable speed drive accelerates/decelerates the motor by the range to be masked out.  
A continuous operation within this range is not possible.
- A blocking zone is not active if its bandwidth is set to "0 Hz".

#### Adjacent and overlapping ranges:

- Example on the left: If the ranges are closely spaced, the ranges are passed through as shown.
- Example on the right: If the ranges overlap, the lowest and highest value form a new range. In the status display 0x291F:016, both ranges are shown as active.

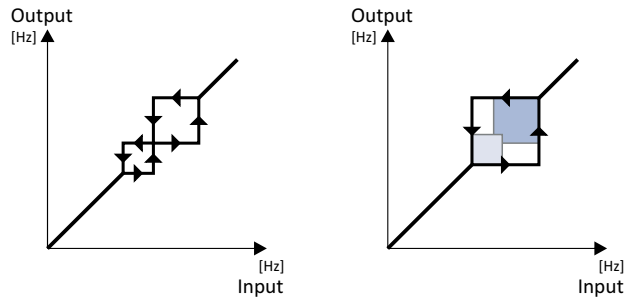

Valid and invalid ranges:

- Example on the left Skip frequency = 5 Hz, bandwidth = 10 Hz  
 → Valid range (starts at  $\geq 0$ )
- Example on the right: Skip frequency = 4 Hz, bandwidth = 10 Hz  
 → Invalid range (starts at  $< 0$ ); is thus ignored.

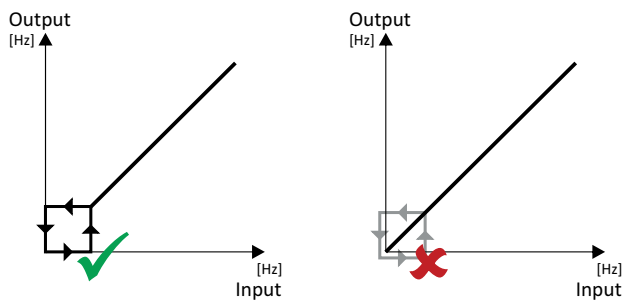

1585 GB 09 18

Parameter	Name / value range / [default setting]	Info
0x291F:001 (P317.01)	Skip frequencies: Skip frequency 1 (Skip frequencies: Skip frequency 1) 0.0 ... [0.0] ... 599.0 Hz	Centre of frequency range 1 which is to be skipped.
0x291F:002 (P317.02)	Skip frequencies: Skip bandwidth 1 (Skip frequencies: Skip bandwidth 1) 0.0 ... [0.0] ... 10.0 Hz	Size of frequency range 1 which is to be skipped.
0x291F:003 (P317.03)	Skip frequencies: Skip frequency 2 (Skip frequencies: Skip frequency 2) 0.0 ... [0.0] ... 599.0 Hz	Centre of frequency range 2 which is to be skipped.
0x291F:004 (P317.04)	Skip frequencies: Skip bandwidth 2 (Skip frequencies: Skip bandwidth 2) 0.0 ... [0.0] ... 10.0 Hz	Size of frequency range 2 which is to be skipped.
0x291F:005 (P317.05)	Skip frequencies: Skip frequency 3 (Skip frequencies: Skip frequency 3) 0.0 ... [0.0] ... 599.0 Hz	Centre of frequency range 3 which is to be skipped.
0x291F:006 (P317.06)	Skip frequencies: Skip bandwidth 3 (Skip frequencies: Skip bandwidth 3) 0.0 ... [0.0] ... 10.0 Hz	Size of frequency range 3 which is to be skipped.

### 8.3.3 OPTIMISING THE STALLING BEHAVIOUR

If the motor is driven with frequencies above the rated motor frequency, the operating point is shifted to the "field weakening range". In this range, the motor voltage does not increase proportionately to the output frequency anymore. As a consequence, the variable speed drive automatically reduces the maximum current since the full torque is not available anymore at these frequencies.

For special motors which enable an operation in the field weakening range, the behaviour in the field weakening range can be adapted to the motor with 0x2B0C (P319.00).

#### **⚠ DANGER!**

Danger by incorrect parameterisation.

Possible consequences: damage to material assets and injury to persons

- ▶ Only change the default setting (0 Hz) in 0x2B0C (P319.00) after consulting the motor manufacturer!
- ▶ Recommendation: Maintain default setting (0 Hz).

1585 GB 09 18

#### Precondition

The function is only effective in the motor control type "V/f characteristic control (VFC open loop)".

#### Details

The operating range of an asynchronous motor consists of the voltage range ① and the field weakening range. The field weakening range again is divided into two ranges:

- In the first range ②, the power can be kept constant without the motor stalling.
- The second field weakening range ③ is characterised by the fact that the maximum permissible stator current is decreased to prevent the motor from stalling.

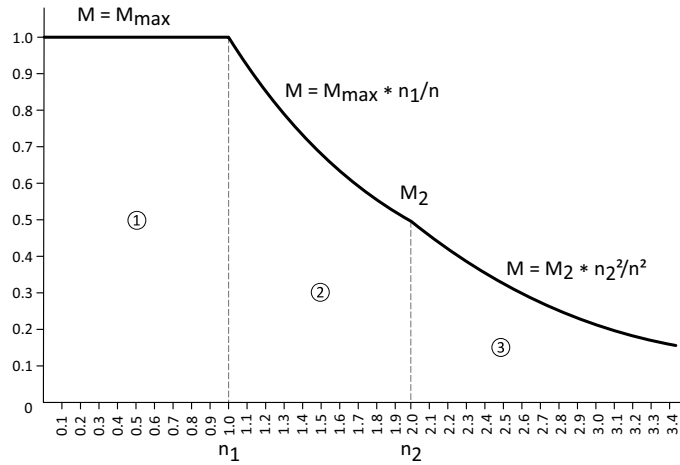

The override point ( $n_2, M_2$ ) can be influenced with 0x2B0C (P319.00).

0x2B0C (P319.00) > 0 Hz:

- The maximum current characteristic is shifted to higher field frequencies by the frequency entered.
- The maximum permissible current and the maximum torque increase in the field weakening range.
- The risk of motor stalling increases.

0x2B0C (P319.00) < 0 Hz:

- The maximum current characteristic is shifted to lower field frequencies by the frequency entered.
- The maximum permissible current and the maximum torque are reduced in the field weakening range.
- The risk of motor stalling is reduced.

Parameter	Name / value range / [default setting]	Info
0x2B0C (P319.00)	Override field weakening (Field weak thold) -599.0 ... [0.0] ... 599.0 Hz	Offset of the override point for field weakening.
0x2B01:002 (P303.02)	V/f shape data: Base frequency (V/f shape data: Base frequency) Device for 50-Hz mains: 0 ... [50] * ... 1500 Hz Device for 60-Hz mains: 0 ... [60] * ... 1500 Hz *Default setting depending on the size.	Base voltage and base frequency define the V/f ratio and thus the gradient of the V/f characteristic - The V/f base voltage is usually set to the rated motor voltage 0x2C01:007 (P320.07). - The V/f base frequency is usually set to the rated motor frequency 0x2C01:005 (P320.05).

### 8.3.4 SLIP COMPENSATION

In case of a load, the speed of an asynchronous motor decreases. This load-dependent speed drop is called slip. The slip compensation serves to counteract the load-dependent speed loss.

#### Precondition

The function is only effective in the motor control type "V/f characteristic control (VFC open loop)". In order that the function can determine the rated slip correctly, the following parameters must be set correctly:

- Rated speed
- Rated frequency
- Number of pole pairs (Automatically calculated from Rated speed and Rated frequency)

#### Details

The slip compensation increases or decreases the output frequency as a response to a load change. Thus, the slip is counteracted and the speed is kept precisely.

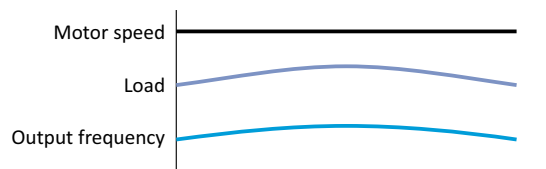

The rated slip required for the slip compensation is calculated by the variable speed drive according to the following formula:

$$\text{Rated slip [\%]} = (1 - (\text{rated motor speed [rpm]} / (120 * \text{rated motor frequency [Hz]} / \text{number of poles}))) * 100$$

#### Calculation example:

- Rated motor speed = 1750 rpm
- Rated motor frequency = 60 Hz
- Number of poles = 2 \* Number of pole pairs = 2 \* 2 = 4
- Rated slip =  $(1 - (1750 / (120 * 60 / 4))) * 100 = 2.77 \%$

The rated slip represents the reduction of the motor speed due to the motor load. At full speed and full load, the motor given in the example would rotate with 1750 rpm, which means 2.77 % below its synchronous speed of 1800 rpm. In order to compensate this speed loss, the variable speed drive increases the output frequency by the rated slip multiplied by the rated motor frequency. In the example  $2.77 \% * 60 \text{ Hz} = 1.66 \text{ Hz}$  increase at full load.

In order to consider load changes, the influence of the rated slip on output frequency can be adapted in 0x2B09:001 (P315.01). A setting of 100 % corresponds to the rated slip of the machine in the nominal operating point.

With reference to the example above and a setpoint frequency of 60 Hz:

- If 0x2B09:001 (P315.01) = 100 %, the output frequency is = 61.66 Hz (60 Hz + 100 % \* 1.66 Hz).
- If 0x2B09:001 (P315.01) = 50 %, the output frequency is = 60.83 Hz (60 Hz + 50 % \* 1.66 Hz).

Additionally the filter time for the slip compensation can be adapted in 0x2B09:002 (P315.02) if required. The preset filter time is adapted to typical motors. If full load or nearly full load oscillations or instabilities occur, we recommend an increase of the filter time.

Parameter	Name / value range / [default setting]	Info
0x2B09:001 (P315.01)	Slip compensation: Gain (Slip compens.: Slip: gain) -200.00 ... [100.00] ... 200.00 %	Adjustment in percent of the slip calculated. - For instance required for deviation of the real motor data from the nameplate data. - A setting of 100 % corresponds to the rated slip of the machine in the nominal operating point.
0x2B09:002 (P315.02)	Slip compensation: Filter time (Slip compens.: Filter time 1 ... [100] ... 6000 ms	Filter time for the slip compensation - The preset filter time is adapted to typical motors.
0x2C02:004 (P351.04)	Slip frequency (Slip frequency) - Read only: x.x Hz	Display of the rated slip determined.
0x2C01:001	Motor parameters: Number of pole pairs - Read only	Display of the number of pole pairs calculated from the rated speed and rated frequency.
0x2C01:004 (P320.04)	Motor parameters: Rated speed (Motor parameters: Rated speed) Device for 50-Hz mains: 50 ... [1450] ... 50000 rpm Device for 60-Hz mains: 50 ... [1750] ... 50000 rpm	General motor data. Carry out setting as specified by motor nameplate data.
0x2C01:005 (P320.05)	Motor parameters: Rated frequency (Motor parameters: Rated frequency) Device for 50-Hz mains: 1.0 ... [50.0] ... 1000.0 Hz Device for 60-Hz mains: 1.0 ... [60.0] ... 1000.0 Hz	Note! When you enter the motor nameplate data, take into account the phase connection implemented for the motor (star or delta connection). Only enter the data applying to the connection type selected.

### 8.3.5 OSCILLATION DAMPING

The oscillation damping serves to reduce the oscillations during no-load operation which are caused by energy oscillating between the mechanical system (mass inertia and the electrical system (DC bus). Furthermore, the oscillation damping can also be used to compensate for resonances.

#### Precondition

The function is only effective in the motor control type "V/f characteristic control (VFC open loop)".

#### Restriction

Observe the following restrictions:

- Damping is possible only for constant oscillations at a steady-state operating point.
- Oscillations occurring sporadically cannot be damped.
- Oscillation damping is not suitable for oscillation occurring during dynamic processes (e.g. acceleration or load changes).
- Oscillation damping is only active if the setpoint speed is greater than 10 rpm and the DC-bus voltage exceeds a value of 100 V.

#### Details

The determination of the oscillation is based on the active current. In order to obtain the alternating component of the active current, this current is differentiated. This signal is then passed through a PT1 filter.

#### Identification of the oscillation

Before the oscillation damping function can be parameterised, the oscillation has to be identified.

One way to do this is to examine the motor current while oscillation damping is switched off (gain = 0 %). At steady-state operation, a constant current flows. If the drive oscillates, these oscillations are also visible on the motor current. It is therefore possible to determine the frequency and the amplitude of the oscillation from the alternating component of the motor current. In the following, this alternating component is referred to as "current oscillation".

#### Parameter setting

The gain of the oscillation signal is to be set according to the following equation:

$$0x2B0A:001 (P318.01) = \text{current amplitude} * 100 \% / (\hat{I}_2 * \text{maximum device current})$$

The default time constant of the PT1 filter should be sufficient for most applications. If required, it is only possible to adapt the time constant via VLBX SW software. Generally, the time constant must be set so that the oscillation can be damped, but that higher-frequency components are filtered from the signal. The time constant is determined from the reciprocal value of the double current oscillation frequency:

$$0x2B0A:002 (P318.02) = 1 / (2 * \text{oscillation frequency})$$

Parameter	Name / value range / [default setting]	Info
0x2B0A:001 (P318.01)	Gain (Gain) -400 ... [150] ... 400 %	Gain of the oscillation signal. - With the setting 0, oscillation damping is deactivated.
0x2B0A:002 (P318.02)	Filter time (Filter time) 1 ... [30] ... 600 ms	Time constant of the PT1 filter.

If there is a need to improve the total power of the system, different options are available:

- a) Tuning of the motor and the speed controller
- b) Automatic motor identification (energized)
- c) Automatic motor calibration (non-energized)

Simply select an option that best suits your environment and requirements!

#### 8.4.1 OPTION FOR OPTIMIZED MOTOR TUNING

The option to be selected depends on the respective application. Depending on the selected option different procedures become active and thus different parameter groups are influenced:

- Rated motor data
- Variable speed drive characteristic
- Motor equivalent circuit diagram data
- Motor controller settings
- Speed controller settings

For further details, see the following subchapters:

- Tuning of the motor and the speed controller
- Automatic motor identification (energized)
- Automatic motor calibration (non-energized)

##### 8.4.1.1 TUNING OF THE MOTOR AND THE SPEED CONTROLLER

The following describes in general how to optimise the speed controller. This may be required if some parameters have on the load side of the drive system have changed or have not been set yet, such as:

- Motor moment of inertia
- Load moment of inertia
- Type of coupling between moment of inertia of the motor and that of the load

Precondition

- All rated motor data are known and set in the variable speed drive.
- All further options for optimisation have been executed before if possible.
  - ▶ Automatic motor identification (energized)
  - ▶ Automatic motor calibration (non-energized)
- Optimisation is possible online or offline (with or without connected motor).

Required steps

Adapt the following parameters to your drive system. Since this only changes load-dependent data, the other parameter groups must not be calculated again.

Parameter	Name / value range / [default setting]	Info
0x2910:001 (P335.01)	Motor moment of inertia (Motor inertia) 0.00 ... [3.70]* ... 20000000.00 kg cm <sup>2</sup> *Default setting depending on the size.	Setting of the moment of inertia of the motor.
0x2910:002 (P335.02)	Load moment of inertia (Load inertia) 0.00 ... [3.70]* ... 20000000.00 kg cm <sup>2</sup> * Default setting depending on the size.	Setting of the moment of inertia of the load. – Always adjust the setting to the current load, otherwise the optimisati process cannot be executed successfully.
0x2910:003	Coupling 0   Stiff 1   Elastic 2   With backlash	Selection of the type of coupling between the moment of inertia of the motor and that of the load.
0x2904	Actual speed filter time 0.0 ... [2.0] ... 50.0 ms	Filter time for the actual speed value.

For further details on the speed controller, see chapter "Speed controller".



#### 8.4.1.2 AUTOMATIC MOTOR IDENTIFICATION (ENERGIZED)

The automatic identification of the motor results in the best possible parameter settings. If the application enables you to energise the system during the optimisation, carry out this optimisation.

##### Precondition

- All rated motor data are known and set in the variable speed drive.
- In 0x2C00 (P300.00), the motor control type required and suitable for the motor is selected.
- In 0x6060 (P301.00), the operating mode "MS: Velocity mode [-2]" is set.
- DC-bus voltage is available.
- The variable speed drive is error-free and in the "Ready to switch on" or "Switched on" device state.
- The motor is stopped (no start enable).
- No inverter disable is active.
- No quick stop is active.
- No other axis command is active anymore.

##### General information on the identification

- The automatic identification can take from some seconds to minutes.
- The procedure can be aborted any time by inverter disable or cancellation of the start enable without settings being changed.
- During and after the procedure, the LED "RDY" (blue) is permanently on.
- After completing a renewed start command is required to start the motor.

##### Required steps

Optimisation with keypad:

1. Request automatic identification: Set 0x2822:004 (P327.04) = "1".
2. Issue the start command to start the procedure.

Parameter	Name / value range / [default setting]	Info
0x2822:004 (P327.04)	Axis commands: Identify motor data (energized) (Axis commands: Identif mot.) 0 ... [0] ... 1	1 = start automatic identification of the motor data. - Inverter characteristics motor equivalent circuit diagram data and controller settings are identified and set automatically. - During the procedure, the motor is energised!

##### Optimisation process

As soon as the process has been started, the following steps are initiated:

1. The inverter characteristic is automatically identified by the variable speed drive.
2. The motor equivalent circuit diagram data are automatically identified by the variable speed drive.
3. The motor controller settings are automatically calculated.
4. The speed controller settings are automatically calculated.

#### 8.4.1.3 AUTOMATIC MOTOR CALIBRATION (NON-ENERGIZED)

If the application does not enable you to energise the system during the optimisation carry out this optimisation.

##### Precondition

- All rated motor data are known and set in the variable speed drive.
- In 0x2C00 (P300.00), the motor control type required and suitable for the motor is selected.
- The variable speed drive is error-free and in the "Ready to switch on" or "Switched on" device state.
- The variable speed drive is disabled or the motor is stopped (no start enable).
- No other axis command is active anymore.

##### Required steps

Optimisation with keypad:

- 0x2822:005 (P327.05) Set = "1" to start the process.

Parameter	Name / value range / [default setting]	Info
0x2822:005 (P327.05)	Axis commands: Calibrate motor data (non-energized) (Axis commands: Calibrate mot.) 0 ... [0] ... 1	1 = start automatic calibration of the motor data. - A default inverter characteristic is loaded. - the motor equivalent circuit diagram data and controller settings are calculated on the basis of the currently set rated motor data. - The motor is not energised.

##### Optimisation process

As soon as the process has been started, the following steps are initiated:

1. A default variable speed drive characteristic is loaded.
2. The motor equivalent circuit diagram data is calculated based on the currently set rated motor data.
3. The motor controller settings are automatically calculated.
4. The speed controller settings are automatically calculated.

#### 8.4.2 INVERTER CHARACTERISTICS

The inverter characteristic is automatically set if one of the following optimisation is carried out:

- ▶ Automatic motor identification (energized)
- ▶ Automatic motor calibration (non-energized)

### 8.4.3 MOTOR EQUIVALENT CIRCUIT DIAGRAM DATA

The motor equivalent circuit diagram data are automatically set if one of the following optimisation is carried out:

- ▶ Automatic motor identification (energized)
- ▶ Automatic motor calibration (non-energized)

Parameter	Name / value range / [default setting]	Info
0x2C01:002	Motor parameters: Stator resistance 0.0000 ... [10.1565]* ... 125.0000 Ω * Default settings depending on the size.	General motor data. Carry out settings as specified by manufacturer data/motor data sheet.
0x2C01:003	Motor parameters: Stator leakage inductance 0.000 ... [23.566]* ... 500.000 mH *Default settings depending on the size.	
0x2C02:001 (P351.01)	Motor parameter (ASM): Rotor resistance (ASM motor par.: Rotor resistance) 0.0000 ... [8.8944]* ... 200.0000 Ω *Default settings depending on the size.	Equivalent circuit data of the motor required for the motor model.
0x2C02:002 (P351.02)	Motor parameter (ASM): Mutual inductance (ASM motor par.: Mutual induct.) 0.0 ... [381.9]* ... 50000.0 mH *Default setting depending on the size.	
0x2C02:003 (P351.03)	Motor parameter (ASM): Magnetising current (ASM motor par.: Magn. current) 0.00 ... [0.96]* ... 500.00 A *Default settings depending on the size.	

1585 GB 09 18

### 8.4.4 MOTOR CONTROLLER SETTINGS

After the motor settings have been made, the different control loops must be set. For a quick commissioning, the calculations and settings are made automatically if one of the following optimisation is carried out:

- ▶ Automatic motor identification (energized)
- ▶ Automatic motor calibration (non-energized)

#### Details

The following controllers have an influence in the respective motor control type:

Controller	Motor control type	
	VFC open loop	SLVC
Current controller	●	●
Field controller		●
Field weakening controller		●
Imax controller	●	
Flying restart controller	●	●
SLVC controller		●
VFC open loop = V/f characteristic control SLVC = sensorless vector control		

#### 8.4.4.1 CURRENT CONTROLLER

For a quick commissioning, the calculation and settings are made automatically during the optimisation.

- i** For typical applications, a manual adaptation of the parameters of the current controller is not recommended. A wrong setting may have a negative effect on the control.  
For special applications, contact the manufacturer before adapting the parameters.

#### Preconditions

The current controller parameters are calculated based on the stator resistance and leakage inductance. Thus, the following parameters must be set correctly, either via optimisation or manually (according to manufacturer-data/motor data sheet):

- 0x2C01:002: Stator resistance
- 0x2C01:003: Stator leakage inductance
- ▶ For details see chapter "Motor equivalent circuit diagram data".

Parameter	Name / value range / [default setting]	Info
0x2942:001 (P334.01)	Current controller parameters: Gain (Current contr.: Gain) 0.00 ... [42.55]* ... 750.00 V/A *Default setting depending on the size.	Gain factor $V_p$ of the current controller.
0x2942:002 (P334.02)	Current controller parameters: Reset time (Current contr.: Reset time) 0.01 ... [4.50]* ... 2000.00 ms *Default setting depending on the size.	Reset time $T_i$ of the current controller.

#### 8.4.4.2 FIELD CONTROLLER

For a quick commissioning, the calculations and settings are made automatically during the optimisation.

##### Precondition

The field controller is only effective in the motor control type "Sensorless vector control (SLVC)".

Parameter	Name / value range / [default setting]	Info
0x29C0:001	Gain 0.00 ... [59.68]* ... 50000.00 A/Vs *Default setting depending on the size.	Gain factor $V_p$ of the field controller.
0x29C0:002	Reset time 1.0 ... [45.5]* ... 6000.0 ms *Default setting depending on the size.	Reset time $T_n$ of the field controller.

1585 GB 09 18

#### 8.4.4.3 FIELD WEAKENING CONTROLLER

For a quick commissioning, the calculations and settings are made automatically during the optimisation.

##### Precondition

The field weakening controller is only effective in the motor control type "Sensorless vector control (SLVC)".

Parameter	Name / value range / [default setting]	Info
0x29E0:001	Field weakening controller setting: Gain 0.000 ... [0.000]* ... 2000000.000 Vs/V *Default setting depending on the size.	Gain factor $V_p$ of the field weakening controller.
0x29E0:002	Field weakening controller setting: Reset time 1.0 ... [1478.3]* ... 240000.0 ms *Default setting depending on the size.	Reset time $T_n$ of the field weakening controller.
0x29E1	Field weakening controller: Field limitation 5.00 ... [100.00] ... 100.00 % – From version 04.00	Field limitation of the field weakening controller.

#### 8.4.4.4 FIELD WEAKENING CONTROLLER (ADVANCED)

For a quick commissioning, the calculations and settings are made automatically during the optimisation.

##### Precondition

The field weakening controller is only effective in the motor control type "Sensorless vector control (SLVC)".

Parameter	Name / value range / [default setting]	Info
0x29E2	DC-bus filter time 1.0 ... [25.0] ... 1000.0 ms	Filter time for the current DC-bus voltage.
0x29E3	Motor voltage filter time 1.0 ... [25.0] ... 1000.0 ms	Filter time for the current motor voltage.
0x29E4 (P354.00)	Voltage reserve range (Voltage reserve) 1 ... [5] ... 20 %	Voltage reserve range at the transition point to the field weakening. – Only relevant if 0x2C00 (P300.00) is set = "Servo control (SC ASM) [2]".

#### 8.4.4.5 IMAX CONTROLLER

For a quick commissioning, the calculations and settings are made automatically during the optimisation.

- i** For typical applications a manual adaptation of the parameters of the I<sub>max</sub> controller is not recommended. A wrong setting may have a negative effect on the control. For special applications contact the manufacturer before adapting the parameters.

##### Precondition

The I<sub>max</sub> controller is only effective in the motor control type "V/f characteristic control (VFC open loop)".

##### Details

The I<sub>max</sub> controller becomes active in the V/f operation if the actual motor current exceeds the maximum overload current "Max current". The I<sub>max</sub> controller changes the output frequency to counteract the exceedance.

The maximum overload current "Max current" is defined in 0x6073 (P324.00) in percent with regard to the rated motor current "Motor rated current" 0x6075 (P323.00).

If the maximum overload current is exceeded:

- During operation in motor mode, the I<sub>max</sub> controller reduces the output frequency.
- During operation in generator mode, the I<sub>max</sub> controller increases the output frequency.

##### Setting notes

If oscillations occur at the current limit during operation:

- Reduce gain of the I<sub>max</sub> controller in 0x2B08:001 (P333.01).
- Increase reset time of the I<sub>max</sub> controller in 0x2B08:002 (P333.02).
- Carry out the changes in small steps only (by 2 ... 3% of the set value) until the oscillations do not exist anymore.

If the I<sub>max</sub> controller does not respond fast enough after the maximum current has been exceeded:

- Increase gain of the I<sub>max</sub> controller in 0x2B08:001 (P333.01).
- Reduce reset time of the I<sub>max</sub> controller in 0x2B08:002 (P333.02).
- Carry out the changes in small steps only (by 2 ... 3% of the set value) until the response time is acceptable.

Parameter	Name / value range / [default setting]	Info
0x2822:019	Axis commands: Calculate I <sub>max</sub> controller parameter 0 ... [0] ... 1	1 = start automatic calculation of the I <sub>max</sub> controller parameters. - Gain 0x2B08:001 (P333.01) and reset time 0x2B08:002 (P333.02) of the I <sub>max</sub> controller are recalculated and set.
0x2B08:001 (P333.01)	V/f I <sub>max</sub> controller: Gain (V/f I <sub>max</sub> contr.: Gain) 0.000 ... [0.284]* ... 1000.000 Hz/A *Default setting depending on the size.	Gain factor V <sub>p</sub> of the I <sub>max</sub> controller.
0x2B08:002 (P333.02)	V/f I <sub>max</sub> controller: Reset time (V/f I <sub>max</sub> contr.: Reset time) 1.0 ... [2.3]* ... 2000.0 ms *Default setting depending on the size.	Reset time T <sub>i</sub> of the I <sub>max</sub> controller.

#### 8.4.4.6 FLYING RESTART CONTROLLER

For a quick commissioning, the calculations and settings are made automatically during the optimisation.

##### Details

The following parameter is only relevant for the flying restart circuit if an asynchronous motor is controlled.

Parameter	Name / value range / [default setting]	Info
0x2BA1:003 (P718.03)	Flying restart circuit: Restart time (Flying restart: Restart time) 1 ... [5911]* ... 60000 ms *Default setting depending on the size.	Integration time for controlling the flying restart circuit.

#### 8.4.4.7 SLVC CONTROLLER

For a quick commissioning, the calculations and settings are made automatically during the optimisation.

##### Precondition

The SLVC controller is only effective in the motor control type "Sensorless vector control (SLVC)".

Parameter	Name / value range / [default setting]	Info
0x2B40:001	Gain 0.0000 ... [0.2686]* ... 1000.0000 Hz/A *Default setting depending on the size.	Gain of the SLVC-Q controller.
0x2B40:002	Reset time 1.0 ... [2.3]* ... 2000.0 ms *Default setting depending on the size.	Reset time of the SLVC-Q controller.

#### 8.4.4.8 TORQUE CONTROL W/ FREQ. LIMIT

In general, the variable speed drive is operated in a mode that controls the motor frequency. Alternatively the variable speed drive can be configured in such a way that it controls a motor torque within a define frequency range.

Typical applications for such a torque control with frequency limitation are winders and packaging machines.

##### Precondition

A torque control is only possible in the motor control type 0x2C00 (P300.00) = "Sensorless vector control (SLVC) [4]". Thus, first this motor control type must be configured.

For details see chapter "Sensorless vector control (SLVC)".

After configuring the sensorless vector control (SLVC), one of the following optimisation must be carried out for a torque control as precise as possible:

- ▶ Automatic motor identification (energized)
- ▶ Automatic motor calibration (non-energized)

##### Details

###### Setpoint selection:

- Instead of a frequency setpoint in [Hz], a torque setpoint has to be defined for the torque control. This can be either a value in percent with reference to the rated motor torque set in 0x6076 (P325.00).
- The standard setpoint source for the torque control can be selected in 0x2860:003 (P201.03) (default setting: Analog input 1).
- Corresponding functions make it possible to change over to other setpoint sources during operation. For details see chapter "Setpoint change-over".

###### Limitation of the torque range:

- The positive and negative torque limit can be set independently of each other.

###### Frequency limitation / speed limitation:

- The adjustable speed limits serve to protect against very high speeds. High speeds can occur if a pure torque is selected without a counter torque being available (load-free machine).
- The torque control controls the assigned torque setpoint within the set speed limits. The actual speed results from the load condition of the application. If the actual speed reaches the set speed limits, it is kept on the respective limit value. This protective function is also called "speed limitation".
- The lower and upper speed limit for speed limitation can be set independently of each other. They can also be defined via analog inputs.

In the following, the steps required for configuring the torque control with frequency limitation are described.

##### Parameterisation required

1. Set the operating mode "MS: Torque mode [-1]" in 0x6060 (P301.00).
2. Set the rated motor torque in 0x6076 (P325.00).
3. Set the permissible maximum torque in 0x6072 (P326.00).
  - The setting is made in percent with reference to the rated motor torque set in 0x6076 (P325.00).
4. Select the source for the positive torque limit in 0x2949:001 (P337.01).
  - Default setting: Maximum torque 0x6072 (P326.00)
  - In case of selection "Analog Input 1 [2]": Set setting range in 0x2636:011 (P430.11) and 0x2636:012 (P430.12).
  - In case of selection "Analog Input 2 [3]": Set setting range in 0x2637:011 (P431.11) and 0x2637:012 (P431.12).
  - In case of selection "Positive torque limit [4]": Set the positive torque limit in 0x60E0.
5. Select the source for the negative torque limit in 0x2949:002 (P337.02).
  - Default setting: (-) Maximum torque 0x6072 (P326.00)
  - In case of selection "Analog Input 1 [2]": Set setting range in 0x2636:011 (P430.11) and 0x2636:012 (P430.12).
  - In case of selection "Analog Input 2 [3]": Set setting range in 0x2637:011 (P431.11) and 0x2637:012 (P431.12).
  - In case of selection "Negative torque limit [4]": Set the negative torque limit in 0x60E1.
6. Select the source for the upper speed limit in 0x2946:003 (P340.03).
  - Default setting: Maximum frequency 0x2916 (P211.00)
  - In case of selection "Analog input 1 [2]": Set setting range in 0x2636:002 (P430.02) and 0x2636:003 (P430.03).
  - In case of selection "Analog input 2 [3]": Set setting range in 0x2637:002 (P431.02) and 0x2637:003 (P431.03).
  - In case of selection "Upper frequency limit [4]": Set the upper speed limit in [Hz] in 0x2946:005 (P340.05).
  - In case of selection "Upper speed limit [5]": Set the upper speed limit in [vel. unit] in 0x2946:001 (P340.01).
7. Select the source for the lower speed limit in 0x2946:004 (P340.04).
  - Default setting: (-) Maximum frequency 0x2916 (P211.00)
  - In case of selection "Analog input 1 [2]": Set setting range in 0x2636:002 (P430.02) and 0x2636:003 (P430.03).
  - In case of selection "Analog input 2 [3]": Set setting range in 0x2637:002 (P431.02) and 0x2637:003 (P431.03).
  - In case of selection "Lower frequency limit [4]": Set the lower speed limit in [Hz] in 0x2946:006 (P340.06).
  - In case of selection "Lower speed limit [5]": Set the lower speed limit in [vel. unit] in 0x2946:002 (P340.02).
8. Select the standard setpoint source for the torque control in 0x2860:003 (P201.03).
  - Default setting: Analog input 1. In case of this selection set the setting range in 0x2636:011 (P430.11) and 0x2636:012 (P430.12).
  - In case of selection "Analog input 2 [3]": Set setting range in 0x2637:011 (P431.11) and 0x2637:012 (P431.12).
  - The torque setpoint must be given in percent with regard to the 0x6076 (P325.00) rated motor torque.
9. Optionally For a "smooth" change-over between different setpoint sources, adapt the ramp time for the torque setpoint in 0x2948:002 (P336.02).

The torque control with frequency limitation is now active and the variable speed drive responds to the torque setpoint given by the selected setpoint source.

## Diagnostic parameters:

- 0x2DD5: Torque setpoint
- 0x2949:003 (P337.03): Actual positive torque limit
- 0x2949:004 (P337.04): Actual negative torque limit
- 0x2946:007 (P340.07): Speed limitation: Actual upper speed limit
- 0x2946:008 (P340.08): Speed limitation: Actual lower speed limit

Parameter	Name / value range / [default setting]	Info
0x2912:001 (P452.01)	Torque setpoint presets: Preset 1 (Torque presets: Torque preset 1) -400.0 ... [100.0] ... 400.0 %	Parameterisable torque setpoints (presets) for operating mode "MS: Torque mode". - 100 % ≡ Motor rated torque 0x6076 (P325.00)
0x2912:002 (P452.02)	Torque setpoint presets: Preset 2 (Torque presets: Torque preset 2) 400.0 ... [100.0] ... 400.0 %	
0x2912:003 (P452.03)	Torque setpoint presets: Preset 3 (Torque presets: Torque preset 3) -400.0 ... [100.0] ... 400.0 %	
0x2912:004 (P452.04)	Torque setpoint presets: Preset 4 (Torque presets: Torque preset 4) -400.0 ... [100.0] ... 400.0 %	
0x2912:005 (P452.05)	Torque setpoint presets: Preset 5 (Torque presets: Torque preset 5) -400.0 ... [100.0] ... 400.0 %	
0x2912:006 (P452.06)	Torque setpoint presets: Preset 6 (Torque presets: Torque preset 6) -400.0 ... [100.0] ... 400.0 %	
0x2912:007 (P452.07)	Torque setpoint presets: Preset 7 (Torque presets: Torque preset 7) -400.0 ... [100.0] ... 400.0 %	
0x2912:008 (P452.08)	Torque setpoint presets: Preset 8 (Torque presets: Torque preset 8) -400.0 ... [100.0] ... 400.0 %	
0x2946:001 (P340.01)	Speed limitation Upper speed limit (Speed limitation Upper limit) -480000 ... [0] ... 480000 vel. unit	Upper limit for the speed limitation - Setting is only effective with the selection "Upper speed limit [5]" in 0x2946:003 (P340.03).
0x2946:002 (P340.02)	Speed limitation Lower speed limit (Speed limitation Lower limit) -480000 ... [0] ... 480000 vel. unit	Lower limit for speed limitation - Setting is only effective with the selection "Lower speed limit [5]" in 0x2946:004 (P340.04).
0x2946:003 (P340.03)	Speed limitation Upper speed limit source (Speed limitation Upps speed lim src)	Selection of the source for the upper speed limit.
	<b>0</b> Maximum frequency	Upper speed limit = Maximum frequency 0x2916 (P211.00).
	1 Fixed Limit 0.0 Hz	Upper speed limit = 0.0 Hz.
	2 Analog input 1	The upper speed limit is defined as analog signal via the analog input 1. ► See chapter "Analog input 1".
	3 Analog input 2	The upper speed limit is defined as analog signal via the analog input 2. ► See chapter "Analog input 2".
	4 Upper frequency limit	Upper speed limit = setting in 0x2946:005 (P340.05) in [Hz].
	5 Upper speed limit	Upper speed limit = setting in 0x2946:001 (P340.01) in [vel. unit].
0x2946:004 (P340.04)	Speed limitation Lower speed limit source (Speed limitation: Lowspeed lim src)	Selection of the source for the lower speed limit.
	<b>0</b> (-) Maximum frequency	Lower speed limit = (-) Maximum frequency 0x2916 (P211.00).
	1 Fixed Limit 0.0 Hz	Lower speed limit = 0.0 Hz.
	2 Analog input 1	The lower speed limit is defined as analog signal via the analog input 1. ► See chapter "Analog input 1".
	3 Analog input 2	The lower speed limit is defined as analog signal via the analog input 2. ► See chapter "Analog input 2".
	4 Lower frequency limit	Lower speed limit = setting in 0x2946:006 (P340.06) in [Hz].
	5 Lower speed limit	Lower speed limit = setting in 0x2946:002 (P340.02) in [vel. unit].
0x2946:005 (P340.05)	Speed limitation: Upper frequency limit (Speed limitation: Upper freq.limit) Device for 50-Hz mains: -1000.0 ... [50.0] ... 1000.0 Hz Device for 60-Hz mains: -1000.0 ... [60.0] ... 1000.0 Hz	Upper limit for the speed limitation. - Setting is only effective with the selection "Lower frequency limit [4]" in 0x2946:004 (P340.04).
	0x2946:006 (P340.06)	Speed limitation: Lower frequency limit (Speed limitation: Lower freq.limit) Device for 50-Hz mains: -1000.0 ... [-50.0] ... 1000.0 Hz Device for 60-Hz mains: -1000.0 ... [-60.0] ... 1000.0 Hz
0x2946:007 (P340.07)	Speed limitation: Actual upper speed limit (Speed limitation: Act uppspeed lim) - Read only: x.x Hz	Display of the current upper limit for speed limitation.
0x2946:008 (P340.08)	Speed limitation: Actual lower speed limit (Speed limitation: Act lows speed lim) - Read only: x.x Hz	Display of the current lower limit for speed limitation.

Parameter	Name / value range / [default setting]	Info
0x2948:002 (P336.02)	Ramp time (Ramp time) 0.0 ... [1.0] ... 60.0 s	Ramp time for operating mode "MS: Torque mode". – The torque setpoint is led via a ramp generator. This provides for a "smooth" switch-over between different setpoint sources. – The set ramp time refers to the ramping up/down of 0 ... 100 % rated motor torque 0x6076 (P325.00). At a lower setpoint selection the ramp time is reduced accordingly.
0x2949:001 (P337.01)	Positive torque limit source (Pos. torqlim src)	Selection of the source for the positive torque limit source.
	<b>0 Max torque</b>	Positive torque limit source = Max torque 0x6072 (P326.00).
	1 Fixed Limit 0.0 %	Positive torque limit source = 0.0 %.
	2 Analog Input 1	The positive torque limit source is defined as analog signal via the analog input 1. ▶ See chapter "Analog input 1".
	3 Analog Input 2	The positive torque limit source is defined as analog signal via the analog input 2. ▶ See chapter "Analog input 2".
	4 Positive torque limit	Positive torque limit source = Positive torque limit 0x60E0.
5 Network target torque	The positive torque limit source is defined as process data object via network. Note. This option is not available for VLA1.	
0x2949:002 (P337.02)	Negative torque limit source (Neg. torqlim src)	Selection of the source for the negative torque limit source.
	<b>0 (-) Max torque</b>	Negative torque limit source = (-) Max torque 0x6072 (P326.00).
	1 Fixed Limit 0.0 %	Negative torque limit source = 0.0 %.
	2 Analog Input 1	The negative torque limit source is define as analog signal via the analog input 1. ▶ See chapter "Analog input 1".
	3 Analog Input 2	The negative torque limit source is defined as analog signal via the analog input 2. ▶ See chapter "Analog input 2".
	4 Negative torque limit	Negative torque limit source = Negative torque limit 0x60E1.
5 Network target torque	The negative torque limit source is defined as process data object via network. Note. This option is not available for VLA1.	
0x2949:003 (P337.03)	Actual positive torque limit (Act postorqlim) – Read only: x.x %	Display of the current positive torque limit. – 100 % ≡ Motor rated torque 0x6076 (P325.00)
0x2949:004 (P337.04)	Actual negative torque limit (Act negtorqlim) – Read only: x.x %	Display of the current negative torque limit. – 100 % ≡ Motor rated torque 0x6076 (P325.00)
0x2DD5	Torque setpoint – Read only: x.xx Nm	Display of the current torque setpoint.

### 8.4.5 SPEED CONTROLLER

The speed controller is automatically set if one of the following optimisations is carried out:

- ▶ Automatic motor identification (energized)
- ▶ Automatic motor calibration (non-energized)

**i** For typical applications, a manual adaptation of the parameters of the speed controller is not recommended. A wrong setting may have a negative effect on the control. For special applications, contact the manufacturer before adapting the parameters.

#### Details

The speed controller has an influence in the following motor control types:

- Sensorless vector control (SLVC)

The automatically calculated settings for the speed controller enable an optimal control behaviour for typical load requirements:

- Minimum speed loss ①
- Minimum settling time ②
- Minimum overshoot ③

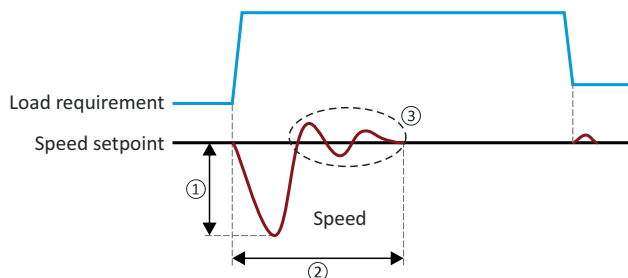

#### Setting notes

If oscillations occur during operation after high load requirements:

- Reduce gain of the speed controller in 0x2900:001 (P332.01).
- Increase reset time of the speed controller in 0x2900:002 (P332.02).

If the speed loss is too high or the settling time too long during operation with high load requirements:

- Increase gain of the speed controller in 0x2900:001 (P332.01).

**i** If the gain is set too high or the reset time too low, the speed control loop can become unstable!

Parameter	Name / value range / [default setting]	Info
0x2900:001 (P332.01)	Speed controller settings: Gain (Speed controller: Gain) 0.00000 ... [0.00193]* ... 20000.00000 Nm/rpm *Default setting depending on the size.	Gain factor $V_p$ of the speed controller.
0x2900:002 (P332.02)	Speed controller setting: Reset time (Speed controller: Reset time) 1.0 ... [80.0]* ... 6000.0 ms *Default setting depending on the size.	Reset time $T_i$ of the speed controller.
0x2904	Actual speed filter time 0.0 ... [2.0] ... 50.0 ms	Filter time for the actual speed value.



## 8.5 MOTOR ROTATING DIRECTION

In the default setting, both direction of motor rotation are enabled. Optionally the direction of rotation can be restricted so that only a clockwise rotation (CW) of the motor is possible.

### Preconditions

Wiring of the motor phases must be carried out correctly with regard to the direction of motor rotation.

In the documentation and the parameter selection texts, the following terms are used for the direction of rotation

- Forward = clockwise direction of rotation (CW)
- Reverse = counter-clockwise direction of rotation (CCW)

### Details

The direction of rotation of the motor can be controlled via the function "Reverse rotational direction". Possible triggers to be selected for the function "Reverse rotational direction" are available for example in 0x2631:013 (P400.13) the digital inputs and internal status signals of the variable speed drive.

If a reversal is not required, the direction of rotation can be restricted in 0x283A (P304.00) to "Only clockwise (CW) [0]".

Parameter	Name / value range / [default setting]	Info
0x283A (P304.00)	Limitation of rotation (Limit. rotation)	Optional restriction of the rotating direction.
	0 Only clockwise (CW)	The motor can only be rotated clockwise (CW). The transfer of negative frequency and PID setpoints to the motor control is prevented. - This function takes effect after the "Reverse rotational direction" function (0x2631:013 (P400.13)). - Since this function only prevents negative setpoints, counter-clock- wise rotation (CCW) is possible if the motor has been wired for this rotating direction.
	1 <b>Both rotational directions</b>	Both directions of motor rotation are enabled.
0x2631:013 (P400.13)	Function list: Reverse rotational direction (Function list: Reverse rot.dir.) - Setting can only be changed if the variable speed drive is inhibited. - For further possible settings, see parameter 0x2631:001 (P400.01).	Assignment of a trigger for the "Reverse rotational direction" function. Trigger = TRUE: the setpoint specific is inverted (i. e. the sign is inverted). Trigger = FALSE: no action / deactivate function again.
	13 <b>Digital input 3</b>	

## 8.6 SWITCHING FREQUENCY CHANGEOVER

The output voltage of the variable speed drive is a DC voltage with sine-coded pulse width modulation (PWM). This corresponds by approximation to a AC voltage with variable frequency. The frequency of the PWM pulses is adjustable and is called "switching frequency".

### Details

The switching frequency has an impact on the smooth running performance and the noise generation in the motor connected as well as on the power loss in the variable speed drive. The lower the switching frequency, the better the concentricity factor, the smaller the power loss and the higher the noise generation.

Parameter	Name / value range / [default setting]	Info
1585 GB 09 18 0x2939 (P305.00)	Switching frequency (Switching freq.) *Default setting depending on the size.	Selection of the variable speed drive switching frequency. Abbreviation used: – "Variable": adaptation of the switching frequency as a function of the current – "Drive-opt.": drive-optimised modulation ("sine/delta modulation") – "Fixed": fixe switching frequency – "Min. Pv": additional reduction of power loss
	1 4 kHz variable / drive-optimise	
	2 8 kHz variable / drive-optimise	
	3 16 kHz variable / drive-optimised	
	5 2 kHz fixed / drive-optimised	
	6 4 kHz fixed / drive-optimised	
	7 8 kHz fixed / drive-optimised	
	8 16 kHz fixed / drive-optimised	
	11 4 kHz variable / min. Pv	
	12 8 kHz variable / min. Pv	
	13 16 kHz variable / min. Pv	
	15 2 kHz constant/min. Pv	
	16 4 kHz constant/min. Pv	
	17 8 kHz constant/min. Pv	
	18 16 kHz constant/min. Pv	
	21 8 kHz variable / drive-optimised / 4 kHz min.	
	22 16 kHz variable / drive-optimised / 4 kHz min.	
	23 16 kHz variable / drive-optimise / 8 kHz min.	
	31 8 kHz variable /min. Pv / 4 kHz min.	
32 16 kHz variable /min. Pv / 4 kHz min.		
33 16 kHz variable /min. Pv / 8 kHz min.		
0x293A (P116.00)	Actual switching frequency (Actual sw. freq.) – Read only	Display of the currently active switching frequency of the variable speed drive. Example: – "16 kHz variable / drive-optimised / 4 kHz min. [22]" is selected as switching frequency in 0x2939 (P305.00). – "16 kHz variable / drive-optimised / 4 kHz min. [22]" is selected as switching frequency in 0x2939 (P305.00). – An increase of the ambient temperature and/or the load have caused a decrease of the switching frequency to 8 kHz. In this case, this parameter indicates the selection "8 kHz power loss-optimise [7]".
	1 2 kHz drive-optimised	
	2 4 kHz drive-optimised	
	3 8 kHz drive-optimised	
	4 16 kHz drive-optimised	
	5 2 kHz power loss-optimised	
	6 4 kHz power loss-optimised	
	7 8 kHz power loss-optimised	
	8 16 kHz power loss-optimised	

## 8.7 MOTOR PROTECTION

Many monitoring functions integrated in the variable speed drive can detect errors and thus protect the device or motor from being destroyed or overloaded.

- Motor overload monitoring ( $I^2 \cdot t$ )
- Current limits
- Overcurrent monitoring
- Motor phase failure detection
- Motor speed monitoring
- Motor torque monitoring

### 8.7.1 MOTOR OVERLOAD MONITORING ( $I^2 \cdot t$ )

This function monitors the thermal utilisation of the motor, taking the motor currents recorded and a mathematical model as a basis.

**⚠ DANGER!**

Fire hazard by overheating of the motor. Possible consequences: Death or severe injuries

- ▶ To achieve full motor protection an additional temperature monitoring function with a separate evaluation must be installed.

#### Details

This function only serves to functionally protect the motor. It is not suitable for the safety-relevant protection against energy-induced hazards, since the implementation is not fail-safe.

- When the thermal motor utilisation calculated reaches the threshold set in 0x2D4B:001 (P308.01), the response set in 0x2D4B:003 (P308.03) is triggered.
- With the setting 0x2D4B:003 (P308.03) = "No response [0]", the monitoring function is deactivated.

**i** For a UL-compliant operation with motor overload protection 0x2D4B:002 (P308.02) and 0x2D4B:003 (P308.03) must be left to the default setting! This setting serves to save the calculated thermal motor utilisation internally when the variable speed drive is switched off and reloaded when it is switched on.

If monitoring is deactivated by the setting 0x2D4B:003 (P308.03) = "No response [0]", no motor overload protection is active. In this case, an external motor overload protection can be provided by the user for a UL-compliant operation.

The following two diagrams show the relation between the motor load and release time of the monitoring under the following conditions:

- Maximum utilisation 0x2D4B:001 (P308.01) = 150 %
- Speed compensation 0x2D4B:002 (P308.02) = "Off [1]" or output frequency  $\geq 40$  Hz

Release time

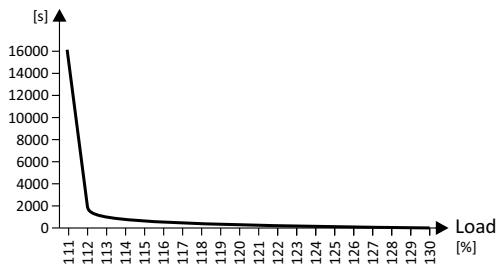

Release time

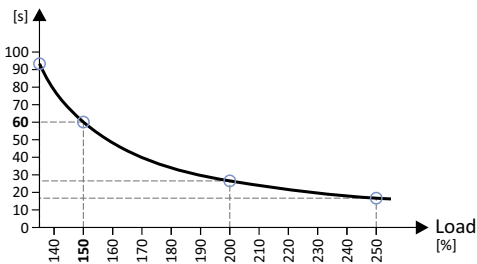

Load * Load ratio	Release time
110 %	Indefinite
135 %	93 s
150 %	60 s
200 %	26 s
250 %	17 s

Depending on the setting in 0x2D4B:001 (P308.01), the release time from the diagrams can be derived as follows:

- Calculation of the load ratio  
Load ratio = 150 % / maximum utilisation 0x2D4B:001 (P308.01) (example: 0x2D4B:001 (P308.01) = 75 % à load ratio = 150 % / 75 % = 2)
- Calculation of the release time of the monitoring:  
Release time = actual load \* load ratio  
(example: actual load = 75 % à release time = 75 % \* 2 = 150 %)
- Looking up the release time from the above table based on load \* load ratio. (example: Load \* load ratio = 150 % à release time = 60 s).

**Speed compensation for protecting motors at low speed**

The variable speed drive comes with an implemented compensation for low speed. If the motor is driven with frequencies lower than 40 Hz, the speed compensation in 0x2D4B:002 (P308.02) should be set to "On [0]" (default setting). This setting serves to reduce the release time of the monitoring at low speed to consider the reduced natural ventilation at AC motors. The speed compensation for UL-compliant operation in 0x2D4B:002 (P308.02) must be set to "On [0]" as well.

If the speed compensation is activated the release time is reduced as follows:

- With an output frequency < 40 Hz: Reduced release time to  $62.5\% + 37.5\% \cdot \text{output frequency [Hz]} / 40 \text{ [Hz]}$
- With an output frequency  $\geq 40$  Hz: No reduced release time

The following diagram shows the reduced release time with activated speed compensation.

- Maximum utilisation 0x2D4B:001 (P308.01) = 150 %
- Speed compensation 0x2D4B:002 (P308.02) = "On [0]"

1585 GB 09 18

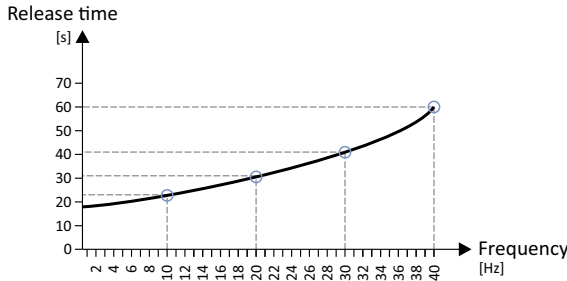

Output frequency	Release time
40 Hz	60 s
30 Hz	≈ 41 s
20 Hz	≈ 31 s
10 Hz	≈ 23 s

The following diagram shows the possible permanent load with activated speed compensation without the monitoring being triggered.

- Maximum utilisation 0x2D4B:001 (P308.01) = 150 %
- Speed compensation 0x2D4B:002 (P308.02) = "On [0]"

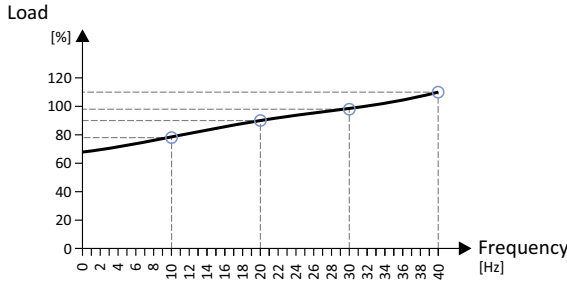

Output frequency	Possible permanent load
40 Hz	110 %
30 Hz	99 %
20 Hz	90 %
10 Hz	79 %

In case of 0 Hz, only a load of 62.7 % ( $\approx 62.5\%$ ) with regard to the load at 40 Hz or above is possible ( $69 / 110 \cdot 100\% = 62.7\%$ ). In case of a deviating setting in 0x2D4B:001 (P308.01), the maximum possible motor load changes proportionately.

Parameter	Name / value range / [default setting]	Info
0x2D4B:001 (P308.01)	Motor overload monitoring ( $i^{2*t}$ ): Maximum utilisation [60 s] (Motor overload: Max.load.for 60s) 30 ... [150] ... 200 %	Maximum permissible thermal motor utilisation (max. permissible motor current for 60 seconds). - 100 % $\equiv$ rated motor current 0x6075 (P323.00) - If the motor is actuated with the current set here for 60 seconds, the maximum permissible thermal motor utilisation is reached and the response set in 0x2D4B:003 (P308.03) is executed. - If the motor is actuated with a different current, the time period until the motor overload monitoring function is activated is different. Generally the following applies: the lower the current, the lower the thermal utilisation and the later the monitoring function is triggered.
0x2D4B:002 (P308.02)	Motor overload monitoring ( $i^{2*t}$ ): Speed compensation (Motor overload: Speed comp.)	Use this function to protect motors that are actuated at a speed below 40 Hz. - UL-compliant operation with motor overload protection requires the setting "On [0]"!
	0 On 1 Off	Release time for motor overload monitoring is reduced in order to compensate for the reduced cooling of naturally ventilated AC induction motors during operation at low speed. Function deactivated, no reduction of the motor overload monitoring release time. May require an external motor overload protection for the UL-compliant operation.
0x2D4B:003 (P308.03)	Motor overload monitoring ( $i^{2*t}$ ): Response (Motor overload: Response) - For further possible settings, see parameter 0x2D45:001 (P310.01).	Selection of the response to the triggering of motor overload monitoring. - UL-compliant operation with motor overload protection requires the setting "error [3]"! - If monitoring is deactivated by the setting 0x2D4B:003 (P308.03) = "No response [0]", no motor overload protection is active. In this case, an external motor overload protection can be provided by the user for a UL-compliant operation.
	3 Fault	
0x2D4B:005	Motor overload monitoring ( $i^{2*t}$ ): Thermal load - Read only	Display of the value of the internal $i^{2*t}$ integrator. - 37500 $\equiv$ 100 % thermal load - When power is switched off this value is saved in the internal EEPROM. - When power is switched on, the saved value is reloaded into the $i^{2*t}$ integrator. - The internal $i^{2*t}$ integrator detects the thermal load based on the load conditions even if the motor overload monitoring is deactivated.

### 8.7.2 CURRENT LIMITS

For the purpose of current limitation, a maximum overload current can be set for the variable speed drive. If the current consumption of the motor exceeds this current limit, the variable speed drive changes its dynamic behaviour, in order to counteract this exceedance.

#### Details

- The maximum overload current of the variable speed drive can be set in 0x6073 (P324.00).
- Reference for the percentage setting of the maximum overload current is the rated motor current set in 0x6075 (P323.00).
- The actual motor current is displayed in 0x2D88 (P104.00).

**i** If the change in the dynamic behaviour carried out by the variable speed drive does not result in exiting the overcurrent state, the variable speed drive outputs an error.

1585 GB 09 18

Load behaviour	Impact
Overload during acceleration in motor mode	A longer time than is required for reaching the frequency setpoint is set.
Overload during deceleration in generator mode	A longer time than is required for reaching standstill is set.
Increasing load at constant frequency	If the motor current limit value is reached: <ul style="list-style-type: none"> <li>- The variable speed drive reduces the effective speed setpoint until a stable working is set or an effective speed setpoint of 0 rpm is reached.</li> <li>- If the load is reduced, the variable speed drive increases the effective speed setpoint until the setpoint speed is reached or the load reaches the current limit value again.</li> </ul>
	When the generator current limit value is reached: <ul style="list-style-type: none"> <li>- The variable speed drive increases the effective speed setpoint until a stable working point is reached or up to the maximum permissible output frequency 0x2916 (P211.00).</li> <li>- If the load is reduced, the variable speed drive reduces the effective speed setpoint until the setpoint speed is reached or the load reaches the current limit value again.</li> </ul>
	If an abrupt load is building at the motor shaft (e.g. drive is blocked), the overcurrent switch-off function may respond.

Example: Overcurrent switch-off in case of a sudden load at the motor shaft

Frequency setpoint selection

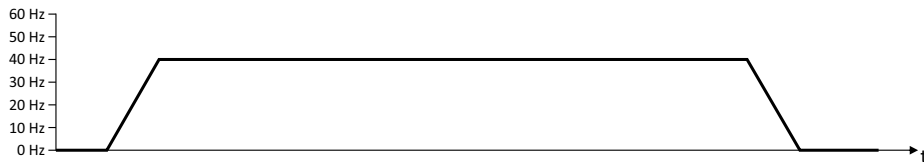

Output frequency

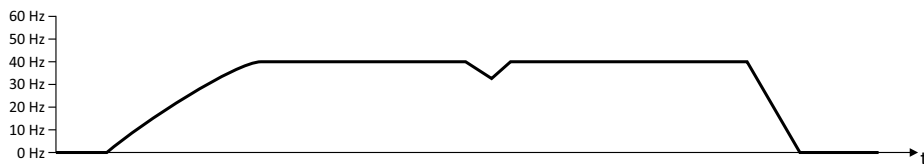

Motor load

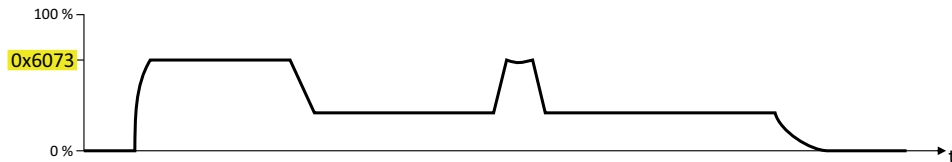

Parameter	Name / value range / [default setting]	Info
0x6073 (P324.00)	Max current (Motor current) 0.0 ... [200.0] ... 3000.0 %	Maximum overload current of the variable speed drive. - 100 % ≡ Motor rated current 0x6075 (P323.00) - 100 % ≡ Motor rated current 0x6075 (P323.00) - If the current consumption of the motor exceeds this current limit, the variable speed drive changes its dynamic behaviour, in order to counteract this exceedance. - If the change in the dynamic behaviour carried out by the variable speed drive does not result in exiting the overcurrent state, the variable speed drive outputs an error. Note! This parameter is not identical to the so-called ultimate motor current IULT ! - The ultimate motor current set in 0x2D46:001 (P353.01) is a limit value for synchronous motors that serves to protect their magnets. - The value to be set here should always be considerably below the ultimate motor current!
0x2D88 (P104.00)	Motor current (Motor current) - Read only: x.x A	Display des present current-r.m.s. value.
0x6078 (P103.00)	Current actual value (Current actual) - Read only: x.x %	Display of the present motor current. - 100 % ≡ Motor rated current 0x6075 (P323.00)

### 8.7.3 OVERCURRENT MONITORING

This function monitors the instantaneous value of the motor current and serves as motor protection

#### NOTICE

With an incorrect parameterisation, the maximum permissible motor current may be exceeded in the process.

Possible consequence: irreversible damage of the motor.

- ▶ The setting of the threshold for the overcurrent monitoring in 0x2D46:001 (P353.01) must be adapted to the connected motor.
- ▶ Set the maximum output current of the inverter in 0x6073 (P324.00) much lower than the threshold for overcurrent monitoring.

1585 GB 09 18

#### Details

The variable speed drive monitors its output current. This monitoring takes place irrespective of the settings for the current limiting function ▶ See the chapter "Current limits".

- If the instantaneous value of the motor current exceeds the threshold set in 0x2D46:001 (P353.01), the response set in 0x2D46:002 (P353.02) takes place.
- With the setting 0x2D46:002 (P353.02) = "No response [0]", the monitoring function is deactivated.

The threshold for the overcurrent monitoring is preset to four times the rated motor current.

This presetting is overwritten in case a the automatic identification or calibration of the motor data is carried out. For a suitable protection the automatically adapted setting should be used.

If disturbances occur during operation, the value can be increased.

Parameter	Name / value range / [default setting]	Info
0x2D46:001 (P353.01)	Overcurrent monitoring: Threshold (Overcurr. monit.: Threshold) 0.0 ... [6.8]* ... 1000.0 A *Default setting depending on the size.	Warning/error threshold for motor current monitoring. – If the instantaneous value of the motor current exceeds the threshold set, the response set in 0x2D46:002 (P353.02) is effected for the purpose of motor protection – The parameter is calculated and set in the course of the automatic identification of the motor. ▶ For details see chapter "Optimisation of the control loops".
0x2D46:002 (P353.02)	Overcurrent monitoring: Response (Overcurr. monit.: Response) – For further possible settings see parameter 0x2D45:001 (P310.01).	Selection of the response to the triggering of motor current monitoring. Associated error code: – 29056   0x7180 - Motor overcurrent
	<b>3   Fault</b>	

### 8.7.4 MOTOR PHASE FAILURE DETECTION

#### Precondition

Phase failure detection during operation is basically only suitable for applications which are operated with a constant load and speed. In other cases, transient processes or unfavourable operating points can cause maloperation.

#### Details

If a current-carrying motor phase (U, V, W) fails during operation, the response selected in 0x2D45:001 (P310.01) is tripped. In case of setting "No response [0]", only an entry is made in the logbook.

A motor phase failure can only be detected if:

1. the rated motor current is higher than 10 % of the rated variable speed drive current and
2. the output frequency is not lower than 0.1 Hz (standstill).

The lower the output frequency the longer the detection of the motor phase failure.

Parameter	Name / value range / [default setting]	Info
0x2D45:001 (P310.01)	Motor phase failure detection: Response (Mot.phase.fail.: Response)	Selection of the response following the detection of a motor phase failure. Associated error codes: – 65289   0xFF09 - Motor phase missing – 65290   0xFF0A - Phase U motor phase failure – 65291   0xFF0B - Motor phase failure phase V – 65292   0xFF0C - Motor phase failure phase W ▶ See chapter "Error types".
	0   No response	
	1   Warning	
	2   Trouble	
	3   Fault	
0x2D45:002 (P310.02)	Motor phase failure detection: Current threshold (Mot.phase.fail.: Current thresh.) 1.0 ... [5.0] ... 25.0 %	Current threshold for the activation of the motor phase failure detection function. – 100 % ≡ Maximum current 0x2DDF:002 – Background: in order to be able to reliably detect the failure of a motor phase, first a certain must flow for the current sensor system. The detection function is therefore only activated if the actual value of the motor current has exceeded the current threshold set here. – Display of the present motor current in 0x2D88 (P104.00).
0x2D45:003 (P310.03)	Motor phase failure detection: Voltage threshold (Mot.phase.fail.: Voltage thresh.) 0.0 ... [10.0] ... 100.0 V	Voltage threshold for motor phase monitoring. – The monitoring function is triggered if the level of the motor current is lower than the device-dependent threshold for longer than 20 ms. – In case of V/f characteristic control, the voltage threshold is considered additionally for the motor phase failure detection. If the motor voltage is higher than the voltage threshold, monitoring is combined with the motor current.

### 8.7.5 MOTOR SPEED MONITORING

This function monitors the motor speed during operation.

#### Preconditions

- In order to detect the current motor speed, the variable speed drive must be enabled and the motor must rotate.
- For an exact monitoring, rated motor speed 0x2C01:004 (P320.04) and rated motor frequency 0x2C01:005 (P320.05) must be set correctly.

#### Details

- If the motor speed reaches the threshold set in 0x2D44:001 (P350.01), the response set in 0x2D44:002 (P350.02) takes place.
- With the setting 0x2D44:002 (P350.02) = "No response [0]", the monitoring function is deactivated.

1585 GB 09 18

Parameter	Name / value range / [default setting]	Info
0x2D44:001 (P350.01)	Overspeed monitoring: Threshold (Overspeed monit.: Threshold) 50 ... [8000] ... 50000 rpm	Warning/error threshold for motor speed monitoring. - If the motor speed reaches the threshold set, the response selected in 0x2D44:002 (P350.02) is effected. - The parameter is calculated and set in the course of the automatic identification of the motor. - The parameter can also be set and thus overwritten by calibrating the motor. ▶ See chapter "Optimisation of the control loops".
0x2D44:002 (P350.02)	Overspeed monitoring: Response (Overspeed monit.: Response) - For further possible settings see parameter 0x2D45:001 (P310.01).	Selection of the response to the triggering of motor speed monitoring.  Associated error code: - 65286   0xFF06 - Motor overspeed
	<b>3 Fault</b>	

### 8.7.6 MOTOR TORQUE MONITORING

This function monitors the motor torque during operation.

#### Preconditions

The motor torque monitoring can only be used for sensorless vector control (SLVC) motor control type with speed controller.

#### Details

This function sets the internal status signal "Torque limit reached [79]" = TRUE if the maximum possible torque has been reached.

- The status signal is set irrespective of the response 0x2D67:001 (P329.01) and delay time 0x2D67:002 (P329.02) set for this monitoring.
- The user can use the status signal to activate certain functions.  
▶ See chapter "Flexible I/O configuration".
- The status signal also serves to set a digital output  
▶ See chapter "Configuration of digital outputs".

Parameter	Name / value range / [default setting]	Info
0x2D67:001 (P329.01)	Maximum torque monitoring: Response (MaxTrq.Monitor: Response) - For further possible settings see parameter 0x2D45:001 (P310.01).	Selection of response to reaching the maximum possible torque. - The selected response takes place if the status signal "Torque limit reached [79]" = TRUE and the deceleration time set in 0x2D67:002 (P329.02) has elapsed.  Associated error code: - 33553   0x8311 - Torque limit reached
	<b>0 No response</b>	
0x2D67:002 (P329.02)	Maximum torque monitoring: Triggering delay (MaxTrq.Monitor: Triggering delay) 0.000 ... [0.000] ... 10.000 s	Optional setting of a deceleration for triggering the response selected in 0x2D67:001 (P329.01). Typical application: - The motor should be driven at the torque limit for a short time without triggering the selected response. - Only after a longer operation (> set deceleration) at the torque limit, the selected response is to take place.
0x6072 (P326.00)	Max torque (Max torque) 0.0 ... [250.0] ... 3000.0 %	Symmetrical selection of the maximum permissible torque. - 100 % ≡ Motor rated torque 0x6076 (P325.00) - This parameter serves to implement a statically and bipolarly acting torque limitation This can be used, for instance, as overload protection of the mechanical transmission path/elements starting at the motor shaft. - This limitation acts irrespective of the torque limitations acting in unipolar mode that are set in 0x60E0 and 0x60E1.
0x60E0	Positive torque limit 0.0 ... [250.0] ... 3276.7 %	Positive torque limit source for speed control with torque limitation. - 100 % ≡ Motor rated torque 0x6076 (P325.00)
0x60E1	Negative torque limit 0.0 ... [250.0] ... 3276.7 %	Negative torque limit source for speed control with torque limitation - 100 % ≡ Motor rated torque 0x6076 (P325.00)

## 9 CONFIGURING THE PROCESS CONTROLLER

By means of the process controller, a process variable can be regulated, for instance the pressure of a pump. The process controller is also referred to as "PID controller" (PID controller = proportional integral and different controller).

The process controller is part of a closed control loop. The variable to be influenced (controlled variable) is measured continuously by means of a sensor and supplied to the variable speed drive as an analog signal (actual value) which, in the variable speed drive, is then compared to the reference value (setpoint). The system deviation resulting therefrom is supplied to the process controller which, on this basis, decelerates or accelerates the motor speed according to the desired dynamic performance of the control loop, so that, for instance, a pump always generates the desired pressure.

Connection plan (example)

The following sample connection plan shows the control of a pump ①. The feedback of the variable (here: pressure) takes place via a pressure transducer ② connected to the analog input 1.

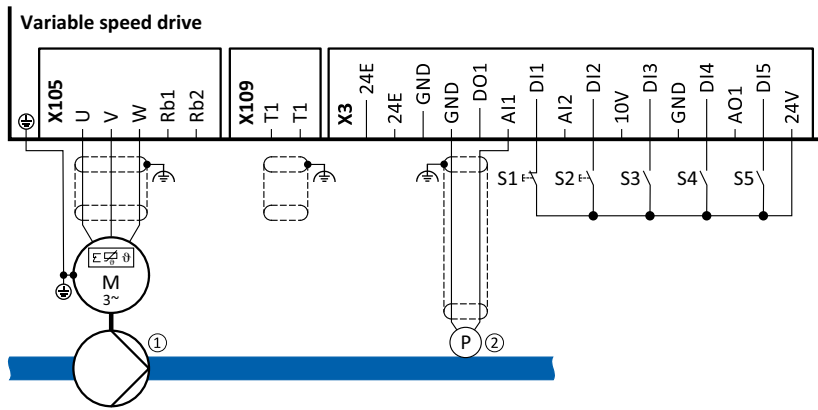

The digital inputs can be used to activate functions of the process controller. The specific assignment of the digital inputs and type of the contacts (switches or buttons normally-closed contacts or normally-open contacts) depends on the application.

General information on the setting

- The basic setting of the process controller is described in the following subchapter.
  - ▶ See chapter "Basic process controller setting".
- Optionally the motor can be put into an energy-saving idle state if no power is required.
  - ▶ See chapter "Process controller idle state".
- The rinsing function which can be activated in addition accelerates the motor in idle state to a defined speed at regular intervals. The rinsing of a pipe system with a pump that has been in an inactive state for a longer period is a typical application.
  - ▶ See chapter "Process controller rinse function".

### 9.1 BASIC PROCESS CONTROLLER SETTINGS

The process controller is set in two steps:

1. Basic settings
2. Fine adjustment of the PID controller for an optimum control mode.

Basic settings

Based on the default setting, we recommend the following proceeding:

1. Activate PID control: Set the desired operating mode (normal or reverse operation in 0x4020:001 (P600.01)).
2. If the feedback of the variable is to take place via analog input 2 instead of analog input 1: Set 0x4020:002 (P600.02) = "analog input 2 [2]".
3. Configure used analog input:
  - Configure input range.
  - Configure setting range for the PID control.
  - Adapt filter time to minimise impacts of the noise on the variable.
  - Set monitoring response to "No response [0]".
  - ▶ See chapter "Configuration of analog inputs".
4. If a (temporary) change-over to a speed-controlled operation is to be possible via a digital input:
  - Assign a free digital input to the control function "Deactivate PID controller" in 0x2631:045 (P400.45). As long as the digital input provides a TRUE signal, the PID control is ignored and the motor is driven in a speed-controlled way.
  - Set acceleration time 0x4021:001 (P606.01) and deceleration time 0x4021:002 (P606.02) for speed-controlled drive control.
5. Select the standard setpoint source for the reference value in 0x2860:002 (P201.02).
  - Functions for setpoint change-over can be used as well. See chapter "Setpoint change-over".
  - The keypad setpoint can be preset in 0x2601:002 (P202.02).
  - If process controller presets are used, they have to be set in 0x4022:001 (P451.01) ... 0x4022:008 (P451.08).
  - If the analog input is used as setpoint source, it must be configured accordingly.
  - ▶ See chapter "Configuration of analog inputs".
  - If the motor potentiometer is used as setpoint source, this function must be configured accordingly. See chapter "Motor potentiometer setpoint source (MOP)".
6. Set the speed range to be controlled in 0x4020:003 (P600.03).
7. If the output value of the process controller is to be limited, adapt the following parameters:
  - 0x4020:005 (P600.05): Min speed limit
  - 0x4020:006 (P600.06): Max speed limit
8. Try out the following parameters with the default setting and only adapt them if required:
  - 0x404B (P604.00): Setpoint ramp
  - 0x404C:001 (P607.01): Acceleration time for showing the process controller influence
  - 0x404C:002 (P607.02): Deceleration for hiding the process controller influence
9. Diagnostics: Check current reference value and feedback of the variable:
  - The current reference value (setpoint) is displayed in 0x401F:001 (P121.01).
  - The current variable (actual value) is displayed in 0x401F:002 (P121.02).

After the basic setting of the process controller has been carried out, a fine adjustment of the PID controller must be executed for an optimum control mode (see the following section).



### Fine adjustment of the PID controller

The dynamics of the PID controller is parameterised based on the gain of the P component 0x4048 (P601.00), the reset time for the I component 0x4049 (P602.00) and the gain of the D component 0x404A (P603.00). In the default setting, the process controller operates as PI controller, the D component is deactivated.

### Basics

- If only the P component is used and the system operates in a steady-state status (reference value is constant and process variable is controlled to a fixed value), a certain system deviation always continues to exist. This remaining system deviation is also called "stationary deviation".
- The I component prevents a permanent fluctuation around the setpoint. Here, the reset time 0x4049 (P602.00) determines how much the duration of the control deviation influences the control. A high reset time means a lower influence of the I component and vice versa.
- The D component does not respond to the height of the system deviation but to their rate of change only. The D component acts as a "damper" for overshoots. Overshoots may occur if the control tries to respond quickly to changes in the system deviation or the reference value. Thus, the D component reduces the risk of instabilities due to overshoots.

**I** For most applications the setting of the gain of the P component and the reset time for the I component is sufficient for the fine adjustment. The setting of the gain of the D component may be required for a further stabilisation of the system especially if a quick response to system deviations is to take place.

### Execute fine adjustment:

1. Set the reset time for the I component to 6000 ms in 0x4049 (P602.00) to deactivate the I component.
  - With this setting and the default setting of 0x404A (P603.00), the process controller operates as P controller.
2. Increase gain of the P component step by step in 0x4048 (P601.00) until the system gets instable.
3. Reduce gain again until the system is stable again.
4. Reduce gain by another 15 %.
5. Set reset time for the I component in 0x4049 (P602.00).
  - With this setting it should be noted that a too low reset time may cause overshoots, especially in case of high steps of the system deviation.
6. Set optional gain of D component in 0x404A (P603.00).
  - With this setting it should be noted that the D component responds very sensitively to electrical disturbance on the feedback as well as digitisation errors.

### Internal signal flow

The following illustration shows the internal signal flow of the process controller (without the additional functions "idle state" and "rinsing function").

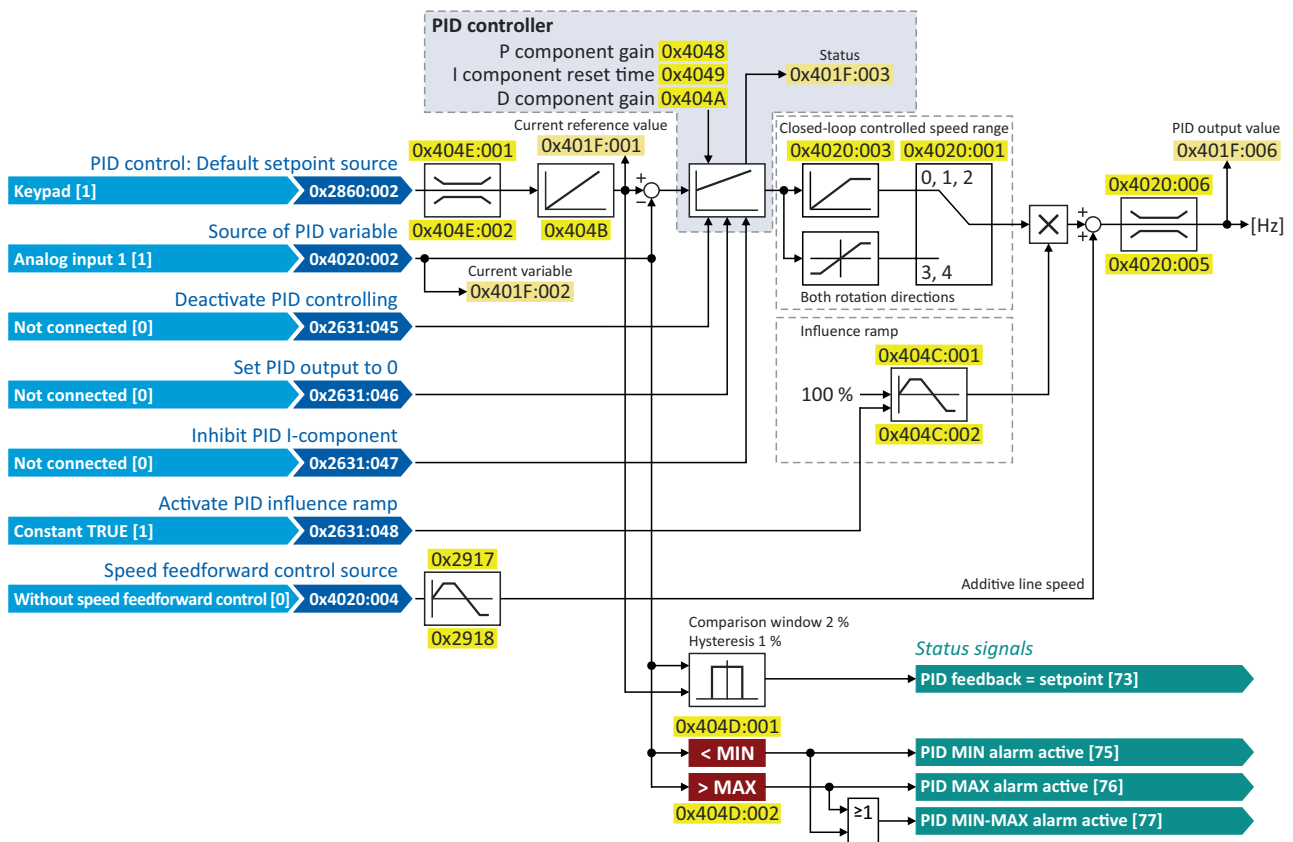

### Control functions

The flexible I/O configuration serves to configure different control functions for the process controller:

- 0x2631:045 (P400.45): Deactivate PID controller
- 0x2631:046 (P400.46): Set process controller output to 0
- 0x2631:047 (P400.47): Inhibit process controller I-component
- 0x2631:048 (P400.48): Activate PID influence ramp

For details see chapter "Process controller function selection".

### Status signals for configurable outputs

The process controller provides different internal status signals. These status signals can be assigned to the relay or the digital outputs.

For details see chapter "Configuration of digital outputs".

Parameter	Name / value range / [default setting]	Info
0x400B:011 (P592.11)	Process input data: PID feedback (Process data IN: PID feedback) -300.00 ... [0.00] ... 300.00 PID unit	Mappable parameter for the feedback of the variable (actual value) via network. - Only effective with the selection "Network[5]" in 0x4020:002 (P600.02). Note. This function is not available for VLA1.

Parameter	Name / value range / [default setting]	Info
0x4020:001 (P600.01)	Process controller setup (PID): Operating mode (PID setup: Operatin mode)	Selection of the process controller operating mode.
	<b>0</b> <b>Inhibited</b>	Process controller deactivated
	1 Normal operation	The setpoint is higher than the fed back variable (actual value). If the system deviation increases, the motor speed is increased. Example: pressure-controlled booster pumps (increase in the motor speed produces an increase in pressure.)
	2 Reverse operation	The setpoint is lower than the fed back variable (actual value). If the system deviation increases, the motor speed is increased. Example: temperature-controlled cooling water pump (increase in motor speed produces decrease in temperature.)
	3 Normal bi-directional	The direction of rotation corresponds to the sign of the system deviation. If the system deviation increases, the motor speed is increased.
4 Reverse bi-directional	A negative system deviation causes a positive direction of rotation. If the system deviation increases, the motor speed is increased.	
0x4020:002 (P600.02)	Process controller setup (PID): PID process variable (PID setup: PID process var.)	Selection of the source via which the feedback of the controlled variable (actual value) for the process controller is effected.
	<b>1</b> <b>Analog input 1</b>	
	2 Analog input 2	
	3 DC-bus voltage	
	4 Motor Current	
5 Network (not available for VLA1)		
0x4020:003 (P600.03)	Process controller setup (PID): Closed-loop controlled speed range (PID setup: PID speed range) 0 ... [100] ... 100 %	Setting of the maximum output frequency up to which the process controller carries out regulation. – 100 % ≡ Maximum frequency 0x2916 (P211.00).
0x4020:004 (P600.04)	Process controller setup (PID): Speed feedforward control source (PID setup: PID line speed)	Optional selection of a speed feedforward control source for the process controller. – Is advisable, for instance, for dancer position controls if the motor speed must not fall below line speed (process controller output value = line speed + controlled motor speed). – Is advisable, for instance, for dancer position controls if the motor speed must not fall below line speed (process controller output value = line speed + controlled motor speed). – Standard applications usually do not require a speed feedforward control; therefore it is deactivated in the default setting.
	<b>0</b> <b>Without speed addition</b>	
	1 Keypad frequency setpoint	
	2 Analog input 1	
	3 Analog input 2	
	4 Frequency preset 1	
	5 Frequency preset 2	
	6 Frequency preset 3	
7 Frequency preset 4		
8 Network (not available for VLA1)		
0x4020:005 (P600.05)	Process controller setup (PID): Min speed limit (PID setup: Min speed lim) -100.0 ... [-100.0] ... 100.0 %	Configuration of the process controller – 100 % ≡ Maximum frequency 0x2916 (P211.00). – The limitation becomes effective after the line speed has been added. – The value set here also limits the I component of the PID controller (Integrator-Anti-Windup)
0x4020:006 (P600.06)	Process controller setup (PID): Max speed limit (PID setup: Max speed lim) -100.0 ... [100.0] ... 100.0 %	Maximum output value of the process controller. – 100 % ≡ Maximum frequency 0x2916 (P211.00). – The limitation becomes effective after the line speed has been added. – The value set here also limits the I component of the PID controller (Integrator-Anti-Windup)
0x4021:001 (P606.01)	PID speed operation Acceleration time (PID speed op.: Accel. time) 0.0 ... [1.0] ... 3600.0 s	Acceleration time for (temporary) speed-controlled drive control in process controller mode. – The acceleration tim etakes effec at the output of the process controller.
0x4021:002 (P606.02)	PID speed operation Deceleration time (PID speed op.: Decel. time) 0.0 ... [1.0] ... 3600.0 s	Deceleration time for (temporary) speed-controlled drive control in process controller mode. – The deceleration time takes effect at the output of the process controller. – Exception: In case of quick stop, the quick stop delay time is effective
0x4048 (P601.00)	PID P-component (PID P-component) 0.0 ... [5.0] ... 1000.0 %	Output frequency of the process controller per 1 % system deviation – 100 % ≡ maximum frequency 0x2916 (P211.00).
0x4049 (P602.00)	PID I- component (PID I- component) 10 ... [400] ... 6000 ms	Reset time for system deviation – With the setting "6000 ms", the I component is deactivated – The I component can also be deactivated via the "Inhibit process controller I-component" 0x2631:047 (P400.47) function.
0x404A (P603.00)	PID D-component (PID D-component) 0.0 ... [0.0] ... 20.0 s	D component, does not respond to the rate of the system deviation, but only to its rate of change.
0x404B (P604.00)	PID setpoint ramp (PID setp.ramp) 0.0 ... [20.0] ... 100.0 s	Acceleration time and deceleration time for the process controller setpoint, relating to the entire setting range of the process controller.
0x404C:001 (P607.01)	PID influence: Acceleration time for activation (PID influence Activation time) 0.0 ... [5.0] ... 999.9 s	If the trigger assigned in 0x2631:048 (P400.48) of the "Activate PID influence ramp" function is TRUE, the influence of the process controller is shown by means of a ramp with the acceleration tim set here.
0x404C:002 (P607.02)	PID influence: Deceleration time for masking out (PID influence Mask out time) 0.0 ... [5.0] ... 999.9 s	If the trigger assigned in 0x2631:048 (P400.48) of the "Activate PID i nfluence ramp" function is FALSE, the influence of the process controller is hidden via a ramp with the deceleration time set here.

Parameter	Name / value range / [default setting]	Info
0x404D:001 (P608.01)	PID alarms: MIN alarm threshold (PID alarms: MIN alarm thrsh.) -300.00 ... [0.00] ... 300.00 PID unit	Trigger threshold for the status signal "PID MIN alarm active [75]". – The "PID MIN alarm active [75]" status signal is TRUE if the fed back variable (with activated PID control) is lower than the threshold set here.
0x404D:002 (P608.02)	PID alarms: MAX alarm threshold (PID alarms: MAX alarm thrsh.) -300.00 ... [100.00] ... 300.00 PID unit	Trigger threshold for the status signal "PID MAX alarm active [76]". – The "PID MAX alarm active [76]" status signal is TRUE if the fed back variable (with activated PID control) is higher than the threshold set here.
0x404D:003 (P608.03)	PID alarms: Monitoring bandwidth PID feedback signal (PID alarms: Bandw. feedback) 0.00 ... [2.00] ... 100.00 %	Hysteresis for status signal "PID feedback = setpoint [73]". – 100 % = configured variable input range – Example: Variable input range 0 ... 10 V: 2 % = 0.2 V – The status signal "PID feedback = setpoint [73]" is TRUE if the control variable fed back = process controller setpoint (± hysteresis set here).
0x404E:001 (P605.01)	PID setpoint limits: Minimum setpoint (PID setp. limit: Minimum setpoint) -300.00 ... [-300.00] ... 300.00 PID unit	Minimum value of the process controller setpoint.
0x404E:002 (P605.02)	PID setpoint limits: Maximum setpoint (PID setp. limit: Maximum setpoint) -300.00 ... [300.00] ... 300.00 PID unit	Maximum value of the process controller setpoint.

Parameter	Name / value range / [default setting]	Info
0x2860:002 (P201.02)	PID control: Default setpoint source (Std. setpoints: PID setp. src.)	Selection of the standard setpoint source for the reference value of the PID control. – The selected standard setpoint source is always active with an activated PID control when no setpoint change-over to another setpoint source via corresponding triggers/functions is active.
	1 Keypad	The setpoint is specified locally by the keypad. – Default setting 0x2601:002 (P202.02) – Use the <b>↑</b> and <b>↓</b> navigation keys to change the keypad setpoint (also during running operation)
	2 Analog input 1	The setpoint is defined as analog signal via the analog input 1. ▶ See chapter analog input 1.
	3 Analog input 2	The setpoint is defined as analog signal via the analog input 2. ▶ See chapter analog input 2.
	5 Network	The setpoint is defined as process data object via the network. Note. This function is not available for VLA1.
	11 PID preset 1	For the setpoint selection, preset values can be parameterised and selected. ▶ See chapter "Setpoint source of preset setpoints".
	12 PID preset 2	
	13 PID preset 3	
	14 PID preset 4	
	15 PID preset 5	
	16 PID preset 6	
	17 PID preset 7	
	18 PID preset 8	
	31 Segment preset 1	For the setpoint selection, the segment presets parameterised for the "sequencer" function can be selected as well. ▶ See chapter "Sequencer".
	32 Segment preset 2	
	33 Segment preset 3	
	34 Segment preset 4	
	35 Segment preset 5	
	36 Segment preset 6	
	37 Segment preset 7	
38 Segment preset 8		
50 Motor potentiometer	The setpoint is generated by the "motor potentiometer" function. This function can be used as an alternative setpoint control which is controlled via two signals: "MOP setpoint up" and "MOP setpoint down". ▶ See chapter "Motor potentiometer setpoint source (MOP)".	
201 Internal value		
202 Internal value		
203 Internal value		
204 Internal value		
205 Internal value		
206 Internal value		
0x401F:003 (P121.03)	Status (PID status) – Read only	Bit-coded status display of the process controller.
	Bit 0 Process controller off	
	Bit 1 PID output set to 0	
	Bit 2 PID I-component inhibited	
	Bit 3 PID influence active	
	Bit 4 Setpoint = actual value	
	Bit 5 Idle state active	
	Bit 6 Max. alarm	
Bit 7 Min. alarm		

## 9.2.1 PROCESS CONTROLLER IDLE STATE

If the PID control is activated this function sets the drive in process controller mode to an energy-saving idle state when no power is required.

## Details

A typical application for this function is a booster pump for water in a high-rise building. If no tenant opens the water tap or uses the shower for a longer period of time, the pump changes to the energy-saving idle state. This usually happens at night. The idle state automatically ends as soon as a tenant opens the tap again. The pumps operates normally again until the condition for the idle state is pending again.

The conditions for activating and terminating the idle state can be set independently of one another in 0x4023:001 (P610.01) and 0x4023:006 (P610.06) (see the following tables).

In 0x4023:005 (P610.05), a delay time can be set for the activation. This is the minimum time the values must fall below or exceed the respective threshold before the idle state is activated.

0x4023:001 (P610.01)	Conditions for activating the idle state				
0	Idle state deactivated				
1	Frequency setpoint 0x2B0E (P102.00)	<	Frequency threshold 0x4023:003 (P610.03)	( +	Delay time 0x4023:005 (P610.05)
2	Frequency setpoint 0x2B0E (P102.00)	<	Frequency threshold 0x4023:003 (P610.03)	( +	Delay time 0x4023:005 (P610.05)
	OR				
3	Current process variable 0x401F:002 (P121.02)	>	Feedback threshold 0x4023:004 (P610.04)	( +	Delay time 0x4023:005 (P610.05)
	OR				
3	Frequency setpoint 0x2B0E (P102.00)	<	Frequency threshold 0x4023:003 (P610.03)	( +	Delay time 0x4023:005 (P610.05)
	OR				
3	Current process variable 0x401F:002 (P121.02)	<	Feedback threshold 0x4023:004 (P610.04)	( +	Delay time 0x4023:005 (P610.05)
	OR				

0x4023:006 (P610.06)	Condition for terminating the idle state				
0	Frequency setpoint 0x2B0E (P102.00)	>	Frequency threshold 0x4023:003 (P610.03)	( +	2 Hz hysteresis
	OR				
0	PID error value 0x401F:007	>	Bandwidth 0x4023:007 (P610.07)	( +	Delay time 0x4023:005 (P610.05)
	OR				
1	Current process variable 0x401F:002 (P121.02)	<	Recovery threshold 0x4023:008 (P610.08)		
2	Current process variable 0x401F:002 (P121.02)	>	Recovery threshold 0x4023:008 (P610.08)		

Parameter	Name / value range / [default setting]	Info
0x4023:001 (P610.01)	PID sleep mode: Activation (PID sleep mode: Activation)	Condition for activating the idle state.
	<b>0 Disabled</b>	Idle state deactivated.
	1 Output frequency < threshold	0x2B0E (P102.00)<0x4023:003 (P610.03) (+ Delay time 0x4023:005 (P610.05))
	2 Output frequency < threshold OR process variable > feedback threshold	0x2B0E (P102.00)<0x4023:003 (P610.03) (+ Delay time 0x4023:005 (P610.05)) OR 0x401F:002 (P121.02)>0x4023:004 (P610.04) (+ Delay time 0x4023:005 (P610.05))
3 Output frequency < threshold OR process variable < feedback threshold	0x2B0E (P102.00)<0x4023:003 (P610.03) (+ Delay time 0x4023:005 (P610.05)) OR 0x401F:002 (P121.02)<0x4023:004 (P610.04) (+ Delay time 0x4023:005 (P610.05))	
0x4023:002 (P610.02)	PID sleep mode: Stop method (PID sleep mode: Stop method)	Selection of the stop method after activation of the idle state.
	<b>0 Coasting</b>	The motor becomes torqueless (coasts down to standstill).
	1 Deceleration to standstill	The motor is brought to a standstill with deceleration time 1 (or deceleration time 2, if activated). – Deceleration time 1 can be set in 0x2918 (P221.00). – Deceleration time 2 can be set in 0x291A (P223.00). ► See chapter "Frequency limits and ramp time".
2 Stop method set	The stop method set in 0x2838:003 (P203.03) is used.	
0x4023:003 (P610.03)	PID sleep mode: Frequency threshold (PID sleep mode: Freq. thresh.) 0.0 ... [0.0] ... 599.0 Hz	Frequency threshold for the activation of the idle state. – For comparing "output frequency < threshold" in case of selection 1 ... 3 in 0x4023:001 (P610.01).
0x4023:004 (P610.04)	PID sleep mode: Feedback threshold (PID sleep mode: Feedback thresh.) -300.00 ... [0.00] ... 300.00 PID unit	Feedback threshold for the activation of the idle state. – For comparing "variable > feedback threshold" in case of selection 2 in 0x4023:001 (P610.01). – For comparing "variable < feedback threshold" in case of selection 3 in 0x4023:001 (P610.01).
0x4023:005 (P610.05)	PID sleep mode: Delay time (PID sleep mode: Delay time) 0.0 ... [0.0] ... 300.0 s	Minimum time for which the respective threshold must be underrun or exceeded before the idle state is activated.
0x4023:006 (P610.06)	PID sleep mode: Recovery (PID sleep mode: Recovery)	Condition for terminating the idle state.
	<b>0 Setpoint &gt; threshold OR system deviation &gt; bandwidth</b>	0x2B0E (P102.00) > 0x4023:003 (P610.03) (+ 2 Hz hysteresis) OR 0x401F:007 > 0x4023:007 (P610.07)
	1 Process variable < recovery threshold	0x401F:002 (P121.02) < 0x4023:008 (P610.08)
2 Process variable > recovery threshold	0x401F:002 (P121.02) > 0x4023:008 (P610.08)	
0x4023:007 (P610.07)	PID sleep mode: Bandwidth (PID sleep mode: Bandwidth) 0.00 ... [0.00] ... 300.00 PID unit	Range around the process controller setpoint for terminating the idle state. – 0.00 = bandwidth deactivated
0x4023:008 (P610.08)	PID sleep mode: Recovery threshold (PID sleep mode: Recovery thresh.) -300.00 ... [0.00] ... 300.00 PID unit	Termination threshold for idle state.

## 9.2.2 PROCESS CONTROLLER RINSE FUNCTION

This function accelerates the motor in idle state of the process controller at regular intervals to a defined speed.

### Details

A typical application for this function is the rinsing of a pipe system with a pump that has been in an inactive state for a longer period to prevent deposits.

- In order to activate the rinsing function set the selection "Enabled [1]" in 0x4024:001 (P615.01).
- The following diagram demonstrates the function:

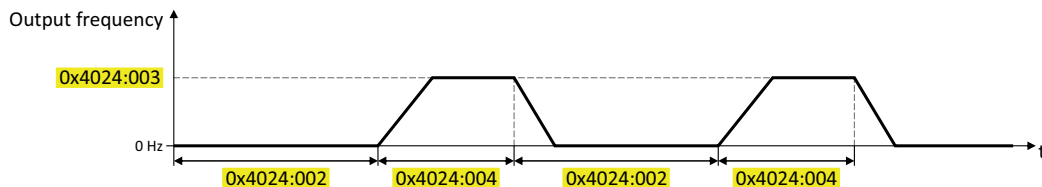

- The rinsing function uses the ramp times set for the "MS: Velocity mode".  
► See chapter "Frequency limits and ramp time".

Parameter	Name / value range / [default setting]	Info
0x4024:001 (P615.01)	Automatic rinsing: Rinsing in idle state (Auto-rinsing: Rinsing in idle)	1 = activate automatic rinsing in idle state.
	<b>0 Inhibited</b>	
	1 Enabled	
0x4024:002 (P615.02)	Automatic rinsing: Rinse interval (Auto-rinsing: Rinse interval) 0.0 ... [30.0] ... 6000.0 min	Time interval between two rinsing processes.
0x4024:003 (P615.03)	Automatic rinsing: Rinse speed (Auto-rinsing: Rinse speed) -599.0 ... [0.0] ... 599.0 Hz	Speed setpoint for rinse function
0x4024:004 (P615.04)	Automatic rinsing: Rinse period (Auto-rinsing: Rinse period) 0.0 ... [0.0] ... 6000.0 s	Duration of a rinsing process.

## 10 ADDITIONAL FUNCTIONS

### 10.1 DEVICE COMMANDS

Device commands are commands for calling organisational function of the variable speed drive, e.g. saving and loading of parameter settings or restoring the default setting.

#### 10.1.1 RESET PARAMETERS TO DEFAULT

With the "Load default setting" device command, all parameters can be reset to the default setting.

**i** By executing this device command, all parameter settings made by the user are lost!

##### Details

– All parameters in the RAM memory of the variable speed drive are set to the default setting stored in the firmware of the variable speed drive. (The persistent parameters in the memory module remain unaffected by this measure.)

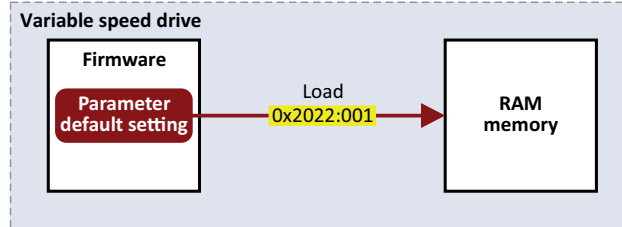

- Afterwards the variable speed drive can be parameterised again on the basis of this initial state.
- Typical application: incorrect or unknown parameter settings.
- The device command only has an effect on the RAM. For a permanent acceptance of the changes made, the data must be saved in the memory module.
  - ▶ See chapter "Saving/loading the parameter settings".

Parameter	Name / value range / [default setting]	Info
0x2022:001 (P700.01)	Device commands: Load default settings (Device commands: Load def. sett.) – Setting can only be changed if the variable speed drive is inhibited.	1 ≙ reset all parameters in the RAM memory of the variable speed drive to the default setting that is stored in the firmware. – All parameter changes made by the user are lost during this process! – It may take some seconds to execute the task. When the task has been executed successfully, the value 0 is shown. – Loading parameters has a direct effect on the cyclic communication: The data exchange for control is interrupted and a communication error is generated.
	<b>0</b> Off / ready	Only status feedback
	1 On / start	Execute device command
	2 In progress	Only status feedback
	3 Action cancelled	
	4 No access	
	5 No access (variable speed drive disabled)	

#### 10.1.2 SAVING/LOADING THE PARAMETER SETTINGS

If parameter settings of the variable speed drive are changed, these changes at first are only made in the RAM memory of the variable speed drive. In order to save the parameter settings with mains failure protection the variable speed drive is provided with a memory module and corresponding device commands.

##### Details

The memory module is provided with two memories, the user memory and the OEM memory.

##### User memory

The user memory is used as power-failure-proof storage of parameter settings made by the user during commissioning/operation.

- The SET display is blinking on the keypad if a parameter setting has been changed but has not been saved in the memory module with mains failure protection. In order to save parameter settings in the user memory of the memory module, press the keypad "Enter" key > 3 s.

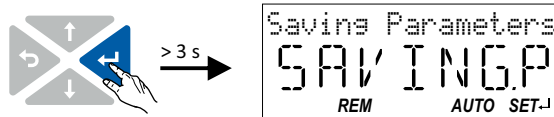

- Parameter settings carried out with VLBX SW must be explicitly saved in the user memory by means of the "Save user data" device command, so that the changes carried out are not lost when the mains of the variable speed drive are switched.
- Saving can also be made in the software VLBX SW via the button.
- The device command "Load user data" serves to reload the data from the user memory into the RAM.

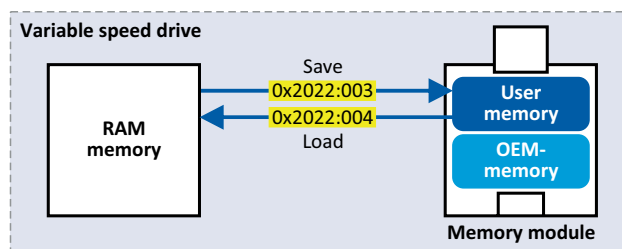

## OEM memory

The OEM memory is provided for the storage of customised parameter settings by the OEM/mechanical engineer. If the user carries out parameter settings with the keypad, they are always saved in the user memory if the keypad Enter key is clicked longer than 3 s. The OEM memory remains unaffected by these changes.

- With the "Load OEM data" device command, the parameter settings preconfigured by the OEM/mechanical engineer can be reloaded to the RAM memory of the variable speed drive anytime, if required.
- For saving parameter settings in the OEM memory, the "Save OEM data" device command must be executed explicitly. The parameter settings are simultaneously saved in the user memory.

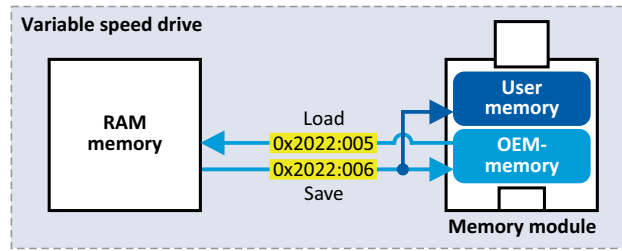

Response after initial switch-on of the variable speed drive

After switch-on, the variable speed drive first tries to load the parameter settings stored in the user memory. If the user memory is empty or damaged, an error message is output and the user must intervene:

- Option 1 = user memory empty: → default setti is loaded automatically from the firmware  
→ data are saved automatically in the user memory of the memory module.
- Option 2 = user- memory damaged: → Error message → default setting is loaded automatically  
→ data are saved automatically in the user memory of the memory module.
- Option 3 = OEM memory empty/damaged: → error message → data are loaded automatically from the user memory of the memory module.

Parameter	Name / value range / [default setting]	Info
0x2022:003 (P700.03)	Device commands: Save user data (Device commands: Save user data) – For further possible settings see parameter 0x2022:001 (P700.01). <b>0</b>   Off / ready	1 = save current parameter settings in the main memory of the memory module with mains failure protection. – It may take some seconds to execute the task. When the task has been executed successfully, the value 0 is shown. – Do not switch off the supply voltage during the saving process and do not unplug the memory module from the variable speed drive! – When the variable speed drive is switched on, all parameters are automatically loaded from the main memory of the memory module to the RAM memory of the variable speed drive.
0x2022:004 (P700.04)	Device commands: Load user data (Device commands: Load user data) – Setting can only be changed if the variable speed drive is inhibited. – For further possible settings see parameter 0x2022:001 (P700.01). <b>0</b>   Off / ready	1 = load data from the main memory of the memory module to the RAM memory of the variable speed drive. – When the device command has been executed successfully, the value 0 is shown. – Loading parameters has a direct effect on the cyclic communication The data exchange for control is interrupted and a communication error is generated.
0x2022:005 (P700.05)	Device commands: Load OEM data (Device commands: Load OEM data) – Setting can only be changed if the variable speed drive is inhibited. – For further possible settings see parameter 0x2022:001 (P700.01). <b>0</b>   Off / ready	1 = load data from the OEM memory of the memory module to the RAM memory of the variable speed drive. – When the device command has been executed successfully, the value 0 is shown. – Loading parameters has a direct effect on the cyclic communication The data exchange for control is interrupted and a communication error is generated.
0x2022:006 (P700.06)	Device commands: Save OEM data (Device commands: Save OEM data) – For further possible settings see parameter 0x2022:001 (P700.01). <b>0</b>   Off / ready	1 = save current parameter settings in the OEM memory of the memory module with mains failure protection. – At the same time the parameter settings are saved in the main memory of the memory module. – After successful execution, the value 0 is shown.
0x2829 (P732.00)	Automatic storage in the memory module (Auto-Save EPM) <b>0</b>   Inhibit <b>1</b>   Enable	1 = activate automatic saving of parameters in the memory module. – With the setting 0, the "Save user data" 0x2022:003 (P700.03) device command must be explicitly executed, or the "Enter" keypad key must be pressed for longer than 3 s to save the current parameter settings in the memory module of the drive with mains failure protection.

### 10.1.3 DEVICE COMMANDS FOR PARAMETER CHANGE-OVER

The variable speed drive supports several parameter sets. The parameter set can be selected by means of the device commands "Load parameter set 1" ... "Load parameter set 4".

#### DANGER!

Changed parameter settings can become effective immediately depending on the activating method set in 0x4046 (P755.00). The possible consequence is an unexpected response of the motor shaft while the variable speed drive is enabled.

- ▶ If possible, only carry out parameter changes while the variable speed drive is disabled.
- ▶ Certain device commands or settings which might cause a critical state of the drive behaviour can generally only be carried out when the variable speed drive is inhibited.

#### Details

The "parameter change-over" function provides a change-over between four sets with different parameter values for up to 32 freely selectable parameters. For details on the compilation of the parameters and setting of the value sets, see the chapter "Parameter change-over".

The change-over via the device commands depends on the activation method set in 0x4046 (P755.00):

- Activation method = 1 or 3: Change-over takes place immediately.
- Activation method = 0 or 2: The respective device command is only executed if the variable speed drive is disabled.

Parameter	Name / value range / [default setting]	Info
0x2022:007 (P700.07)	Device commands: Load parameter set 1 (Device commands: Load par. set 1) - For further possible settings see parameter 0x2022:001 (P700.01).	1 = load value set 1 of the "Parameter change-over" function - The parameters specified in 0x4041/1...32 are set to the values set in 0x4042/1...32. - After successful execution, the value 0 is shown. ▶ See chapter "Parameter change-over".
	<b>0</b>   Off / ready	
0x2022:008 (P700.08)	Device commands: Load parameter set 2 (Device commands: Load par. set 2) - For further possible settings see parameter 0x2022:001 (P700.01).	1 = load value set 2 of the "Parameter change-over" function - The parameters specified in 0x4041/1...32 are set to the values set in 0x4043/1...32. - After successful execution, the value 0 is shown. ▶ See chapter "Parameter change-over".
	<b>0</b>   Off / ready	
0x2022:009 (P700.09)	Device commands: Load parameter set 3 (Device commands: Load par. set 3) - For further possible settings see parameter 0x2022:001 (P700.01).	1 = load value set 3 of the "Parameter change-over" function - The parameters specified in 0x4041/1...32 are set to the values set in 0x4044/1...32. - After successful execution, the value 0 is shown. ▶ See chapter "Parameter change-over".
	<b>0</b>   Off / ready	
0x2022:010 (P700.10)	Device commands: Load parameter set 4 (Device commands: Load par. set 4) - For further possible settings see parameter 0x2022:001 (P700.01).	1 = load value set 4 of the "Parameter change-over" function - The parameters specified in 0x4041/1...32 are set to the values set in 0x4045/1...32. - After successful execution, the value 0 is shown. ▶ See chapter "Parameter change-over".
	<b>0</b>   Off / ready	

### 10.1.4 DELETE LOGBOOK

By means of the "Delete logbook" device command, all logbook entries can be deleted.

Parameter	Name / value range / [default setting]	Info
0x2022:015 (P700.15)	Device commands: Delete logbook (Device commands: Delete logbook) - Setting can only be changed if the variable speed drive is inhibited.	1 = delete all entries in the logbook.
	<b>0</b>   Off / ready	
	1   On / start	

## 10.2 KEYPAD

For the keypad various settings can be made, which are described in detail in the following subchapters.

### 10.2.1 KEYPAD LANGUAGE SELECTION

Parameter	Name / value range / [default setting]	Info
0x2862 (P701.00)	Keypad setpoint increment (KP setp. incr.) 1 ... [1] ... 100	Adaptation of the increment for keypad setpoints when a keypad arrow key is pressed once. The value set serves as a multiplier for the preset increments. Preset increments: - 0.1 Hz for frequency setpoint 0x2601:001 (P202.01). - 0.01 PUnit for process controller setpoint 0x2601:002 (P202.02). - 1 % for torque setpoint 0x2601:003 (P202.03). Notes: - With a setting > 1, the option of repeatedly changing the setpoint by pressing the key for a longer time is deactivated. - The setting only has an impact on the keypad setpoints. Example: with the setting "5", the keypad frequency setpoint is increased/decreased by 0.5 Hz every time the key is pressed.

### 10.2.3 KEYPAD SCALING OF SPEED DISPLAY

Parameter	Name / value range / [default setting]	Info
0x4002 (P702.00)	Speed display scaling (Scal.speed fact.) 0.00 ... [0.00] ... 650.00	Factor for the scaling of the speed display in 0x400D (P101.00). - With the setting "0.00", no scaling takes place. - Example: with the "16.50" and the actual frequency = 50 Hz, 0x400D (P101.00) shows the speed "825 rpm".
0x400D (P101.00)	Scaled actual value (Scaled act value) - Read only: x Units	Display of the current speed in application units.



## 15.85 GB 09 18



### 10.2.4 KEYPAD STATUS DISPLAY

During operation, the keypad displays the output frequency of the variable speed drive, or with an active PID control it shows the process controller setpoint. Alternatively, an optional diagnostic parameter can be displayed during operation.

Parameter	Name / value range / [default setting]	Info
0x2864 (P703.00)	Keypad status display (KP status displ.) 0x00000000 ... [0x00000000] ... 0xFFFFF00	0 = normal display depending on the operating mode. – In case of an active frequency control, the keypad displays the output frequency of the variable speed drive. – In case of active PID control, the keypad displays the current Process controller setpoint in [P-Unit]. As an alternative, an optional diagnostic parameter can be set here, which is to be shown on the keypad during operation. – Format: 0xiii00 (iiii = hexadecimal index, ss = hexadecimal subindex) – The lowest byte is always 0x00. – The keypad can be used to select the desired diagnostics parameter from a list.

### 10.2.5 KEYPAD - CONFIGURATION OF R/F AND CTRL BUTTON KEYPAD ROTATION SETUP

Use the  keypad to reverse the rotation direction at local keypad control.

– After the  key has been pressed, the reversal of rotation direction must be confirmed with the  key. (The  key serves to cancel the action).

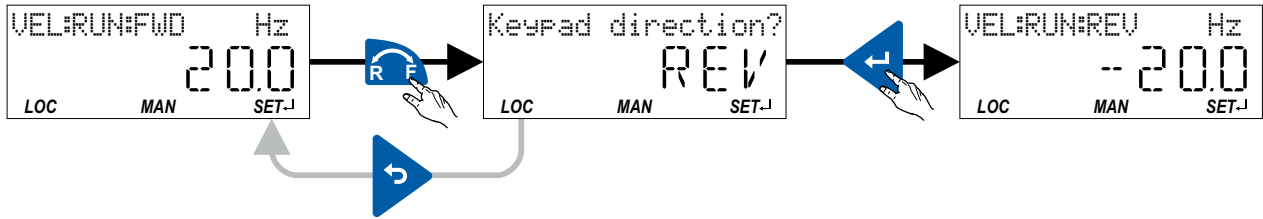

The keypad key 

- directly changes the keypad rotation setup in 0x2602:002 (P708.02).
- has no function if the rotation limitation "Only clockwise (CW) [0]" is set in 0x283A (P304.00).
- has no function in the operating mode 0x6060 (P301.00) = "MS: Torque mode [-1]".
- has no function if the PID control is activated.
- can be deactivated in 0x2602:001 (P708.01).

### Keypad Full Control



Use the CTRL keypad key to activate the "Keypad Full Control" control mode. Both the control and the setpoint selection are then made via the keypad. This special control mode can be, for instance, used during the commissioning phase if external control and setpoint sources are not ready to use yet.

### NOTICE

If the "Keypad Full Control" control mode is active, the "Run" 0x2631:002 (P400.02) function is internally set to TRUE.

In this case, the motor cannot be stopped via this function.

► For stopping the motor, use  keypad key, deactivate the inverter enable or activate the "quick stop" function.

– After the CTRL key has been pressed, the activation of the control mode must be confirmed with the  key. (The  key serves to cancel the action.)

– When the control mode is changed over, the motor is first stopped and the "Forward" direction of rotation is set. Then, the motor can be started and stopped via the keypad.

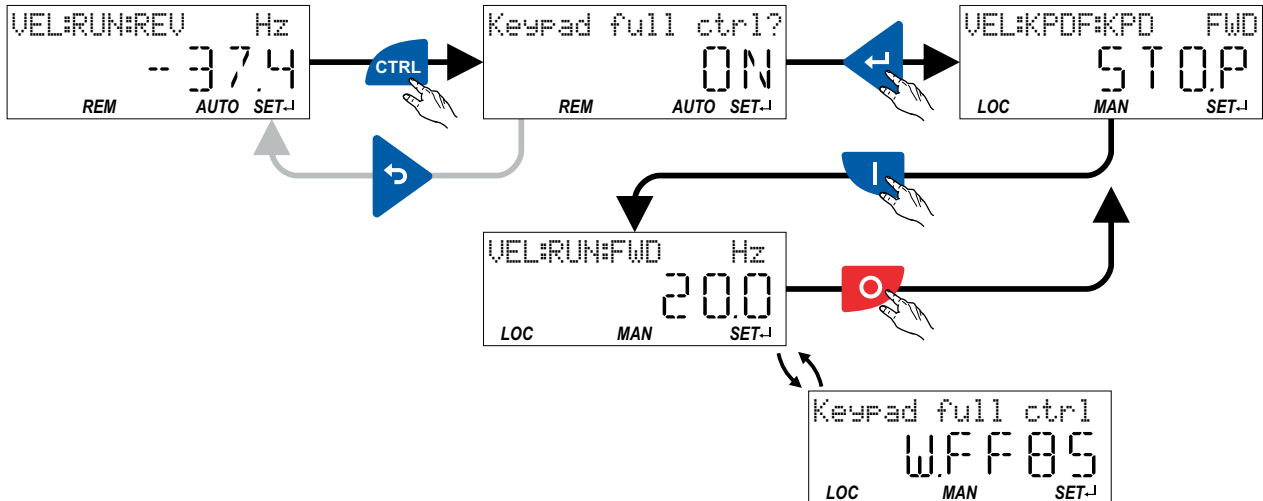

If the "Keypad Full Control" control mode is active:

- the keypad shows the "Keypad full ctrl" warning alternately with the status display.
- the set standard setpoint sources are ignored.
- a change-over to other setpoint sources is not possible.
- the following functions continue to be active:
  - 0x2631:001 (P400.01): Enable inverter
  - 0x2631:003 (P400.03): Activate quick stop
  - 0x2631:005 (P400.05): Activate DC braking
  - 0x2631:010 (P400.10): Jog forward (CW)
  - 0x2631:011 (P400.11): Jog reverse (CCW)
  - 0x2631:013 (P400.13): Reverse rotational direction

Clicking the CTRL keypad key stops the control mode again. The keypad key CTRL

- directly changes the settings in 0x2602:003 (P708.03).
- can be deactivated in 0x2602:001 (P708.01).

Parameter	Name / value range / [default setting]	Info
0x2602:001 (P708.01)	Keypad setup: CTRL & F/R key setup (Keypad setup: CTRL&F/R keys)	Disable/enable CTRL and F/R key of the keypad.
	0 CTRL & F/R Disable	
	1 <b>CTRL &amp; F/R Enable</b>	
	2 CTRL Enable F/R Disable	
0x2602:002 (P708.02)	Keypad setup: Select rotational direction (Keypad setup: Select rot.dir.)	Instructed direction of rotation if local keypad control is active – If the local keypad control is active, this setting can be directly changed via the keypad key  if the key in 0x2602:001 (P708.01) has not been disabled. – When the remote control is changed over to local keypad control and vice versa, this parameter is set to "Forward [0]".
	0 <b>Forward</b>	
	1 Reverse	
0x2602:003 (P708.03)	Keypad setup: Keypad Full Control (Keypad setup: Keypad Full Ctrl)	Activate/deactivate full keypad control. – This setting can be changed directly via the keypad key CTRL if the key in 0x2602:001 (P708.01) has not been disabled. – When the control mode is changed over, the motor is stopped and the "Forward" direction of rotation is set.
	0 <b>Off</b>	
	1 On	

#### 10.4 DC BRAKING

The "DC braking" function generates a braking torque by injecting a DC current into the motor. The function can be used to shorten the braking of a load with high mass inertia. Another application is holding the motor shaft either before starting or while stopping.

##### NOTICE

Avoid long-time activation of the "DC braking" function with a high braking current or a high braking voltage!  
Possible consequence: thermal motor overload.

- ▶ Only use the "DC braking" function in applications in which the load is only exceptionally stopped.
- ▶ Do not activate the "DC braking" function longer than necessary.

##### Precondition

The "DC braking" function is only possible if the variable speed drive is enabled.

##### Details

The function can be used as follows:

1. Automatically when the motor is started.
2. Automatically when the motor is stopped.
3. Manually (via the flexible I/O configuration).

The three options can also be combined, for instance automatic DC braking when starting and stopping the motor.

For further details and configuration examples, see the following chapter:

- ▶ Example 1: Automatic DC braking when the motor is started
- ▶ Example 2: Automatic DC braking when the motor is stopped
- ▶ Activatic DC braking manually

Parameter	Name / value range / [default setting]	Info
0x2B84:001 (P704.01)	DC braking: Current (DC braking: Current) 0.0 ... [0.0] ... 200.0 %	Braking current for DC braking. – 100 % ≡ rated motor current 0x6075 (P323.00)
0x2B84:002 (P704.02)	DC braking: Automatic hold time (DC braking: Hold time autom.) 0.0 ... [0.0] ... 1000.0 s	Hold time for automatic DC braking. – The "Automatic DC braking" function is active for the time set here. – 1000.0 = infinite Note! Do not set this parameter to the value "1000.0" (infinite) if the DC braking is used during the start. The "Infinite" setting can be used to lock the rotor for an indefinite time while a stop is active. However, ensure here that the longer DC braking does not cause a thermal overload of the motor!
0x2B84:003 (P704.03)	DC braking: Automatic operating threshold (DC braking: Threshold autom.) 0.0 ... [0.0] ... 599.0 Hz	Operating threshold for automatic DC braking. – With the setting 0, the "Automatic DC braking" function is deactivated.
0x2B84:004 (P704.04)	DC braking: Demagnetization time (DC braking: Demagnet. time) 0 ... [100] ... 150 %	In the default setting, the DC braking is activated after the standard demagnetising time has elapsed. This parameter can be used to adapt the time. – 100 % ≡ Default demagnetization time 0x2B84:005 (P704.05) Note! A too short demagnetising time can cause an overcurrent error!
0x2B84:005 (P704.05)	DC braking: Default demagnetization time (DC braking: Def. demag. time) – Read only: x ms	Display of the standard demagnetising time as a setting help for the user – This time is calculated by the variable speed drive: Demagnetising time = 7 * rotor time constant.
0x2B84:006 (P704.06)	DC braking: DC brake with inverter disable (DC braking: DCbrk/inv.disab) 0 ... [0] ... 1	1 = behaviour in case of automatic DC braking. After the auto DCB hold time has elapsed, the motor is deenergised (by means of pulse inhibit) until the setpoint exceeds the auto DCB operating threshold.
0x2631:005 (P400.05)	Function list: Activate DC braking (Function list: DC braking) – For further possible settings see parameter 0x2631:001 (P400.01).	Assignment of a trigger for the "Activate DC braking" function Trigger = TRUE: Activate DC braking. Trigger = FALSE: Deactivate DC braking. CAUTION! DC braking remains active as long as the trigger is set to TRUE. ► See chapter "DC braking".
0x2838:001 (P203.01)	Start/stop configuration: Start method (Start/stop cfg: Start method) – Setting can only be changed if the variable speed drive is inhibited.	Behaviour after start command.
	0 Normal	After start command, the standard ramps are active. – Acceleration time 1 can be set in 0x2917 (P220.00). – Deceleration time 1 can be set in 0x2918 (P221.00).
	1 DC braking	After start command, the "DC braking" function is active for the time set in 0x2B84:002 (P704.02). ► See chapter "DC braking".
	2 Flying restart circuit	After the start command, the flying restart circuit is active. The flying restart function makes it possible to restart a coasting motor during operation without speed feedback. Synchronicity between the drive and motor is coordinated so that the transition to the rotating motor is effected without jerk at the time of connection. ► See chapter "Flying restart circuit".
	3 For future use	
0x2838:003 (P203.03)	Start/stop configuration: Stop method (Start/stop cfg: Stop method)	Behaviour after the "Stop" command.
	0 Coasting	The motor becomes torqueless (coasts down to standstill)
	1 Standard ramp	The motor is brought to a standstill with deceleration time 1 (or deceleration time 2, if activated). – Deceleration time 1 can be set in 0x2918 (P221.00). – Deceleration time 2 can be set in 0x291A (P223.00). ► See chapter "Frequency limits and ramp time".
	2 Quick stop ramp	The motor is brought to a standstill with the deceleration time set for the "Quick stop" function. – Deceleration time for quick stop can be set in 0x291C (P225.00). – The "quick stop" function can also be activated manually, for instance via a digital input. ► See chapter "Quick stop".

#### 10.4.1 EXAMPLE 1: AUTOMATIC DC BRAKING WHEN THE MOTOR IS STARTED

In order that the DC braking is automatically active when the motor is started, the start method "DC braking [1]" must be set in 0x2838:001 (P203.01).

- The DC braking is carried out with the braking current set in 0x2B84:001 (P704.01).
- Only after the hold time 0x2B84:002 (P704.02) has elapsed, the motor is accelerated to the setpoint.

Parameter	Name	Setting for this example
0x2631:001 (P400.01)	Enable inverter	Digital input 1 [11]
0x2631:002 (P400.02)	Run	Digital input 2 [12]
0x2631:004 (P400.04)	Reset fault	Not connected [0]
0x2838:001 (P203.01)	Start method	DC braking [1]
0x2860:001 (P201.01)	Frequency control: Default setpoint source	Frequency preset 1 [11]
0x2911:001 (P450.01)	Frequency setpoint presets: Preset 1	40 Hz
0x2B84:001 (P704.01)	Current	50 %
0x2B84:002 (P704.02)	Automatic hold time	10 s

1585 GB 09 18

#### Input signals

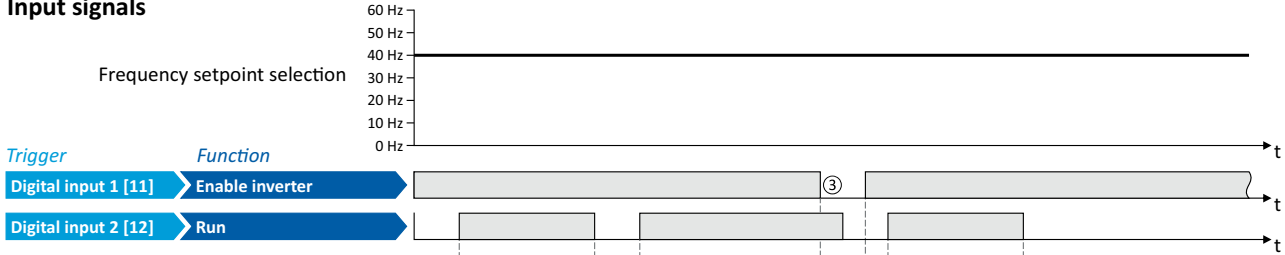

#### Output signals

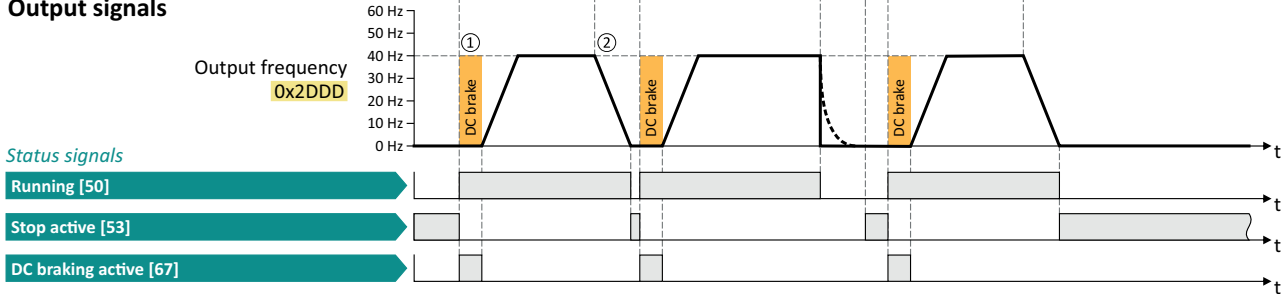

The status signals can be assigned to digital outputs. ► See chapter "Configuration of digital outputs".

- ① After the start command, the DC braking is active. Only after the hold time 0x2B84:002 (P704.02) has elapsed, the motor is accelerated to the setpoint.
- ② The motor is stopped with the stop method set in 0x2838:003 (P203.03). In the example: Stop with standard ramp.
- ③ If the variable speed drive is disabled, the motor coasts.

#### 10.4.2 EXAMPLE 2: AUTOMATIC DC BRAKING WHEN THE MOTOR IS STOPPED

In order that the DC braking is automatically active when the motor is stopped, the corresponding operating threshold must be set in 0x2B84:003 (P704.03).

- After a stop command, the motor is first decelerated as set. Only if the output frequency falls below the set operating threshold, the variable speed drive stops the deceleration and activate DC braking.
- DC braking is carried out with the braking current set in 0x2B84:001 (P704.01) for the hold time set in 0x2B84:002 (P704.02).
- The exact behaviour depends on the stop method set in 0x2838:003 (P203.03).

Stop method = "Standard ramp [1]"

Parameter	Name	Setting for this example
0x2631:001 (P400.01)	Enable inverter	Digital input 1 [11]
0x2631:002 (P400.02)	Run	Digital input 2 [12]
0x2631:004 (P400.04)	Reset fault	Not connected [0]
0x2838:003 (P203.03)	Stop method	Standard ramp [1]
0x2860:001 (P201.01)	Frequency control: Default setpoint source	Frequency preset 1 [11]
0x2911:001 (P450.01)	Frequency setpoint presets: Preset 1	40 Hz
0x2B84:001 (P704.01)	Current	50 %
0x2B84:002 (P704.02)	Automatic hold time	10 s
0x2B84:003 (P704.03)	Automatic operating threshold	15 Hz

#### Input signals

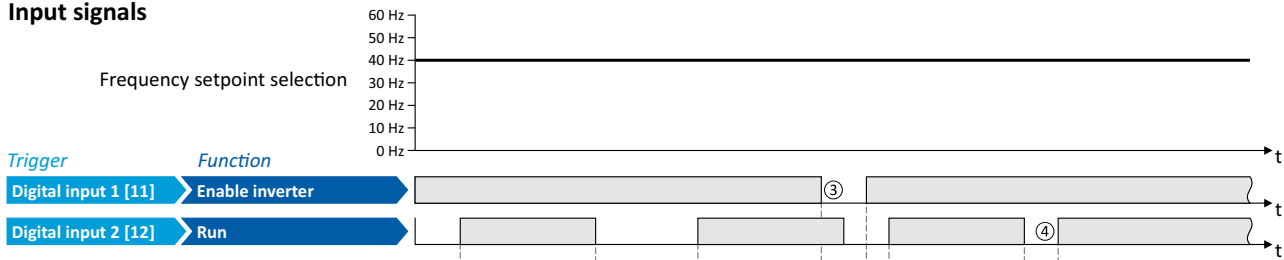

#### Output signals

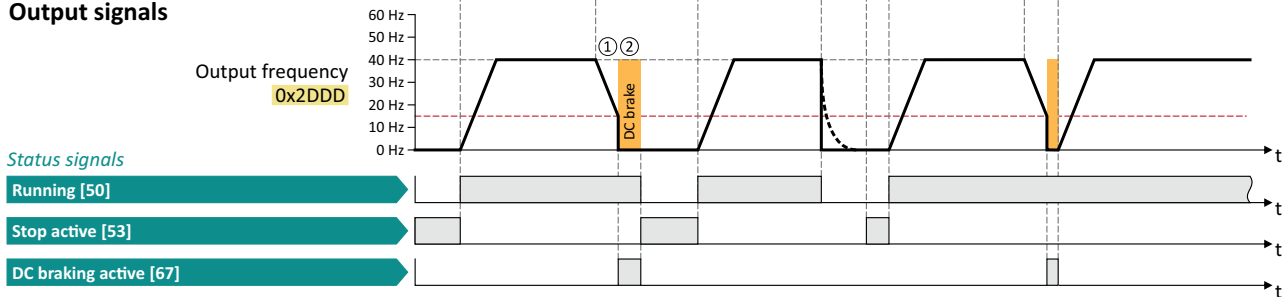

The status signals can be assigned to digital outputs. ► See chapter "Configuration of digital outputs".

- ① With the stop method "Standard ramp [1]", the motor is first decelerated normally until the value falls below the operating threshold set in 0x2B84:003 (P704.03).
- ② The DC braking becomes active for the hold time set in 0x2B84:002 (P704.02).
- ③ If the variable speed drive is disabled, the motor coasts. (DC braking is only possible if the variable speed drive is enabled.)
- ④ If there is a new start command within the hold time, the DC braking is cancelled. The motor is accelerated to the setpoint again.

Stop method = "Quick stop ramp [2]"

Same behaviour as with the stop method "Standard ramp [1]", except that the motor is decelerated with the quick stop ramp instead of the standard ramp.

Stop method = "Coasting [0]"

Parameter	Name	Setting for this example
0x2631:001 (P400.01)	Enable inverter	Digital input 1 [11]
0x2631:002 (P400.02)	Run	Digital input 2 [12]
0x2838:003 (P203.03)	Stop method	Coasting [0]
0x2860:001 (P201.01)	Frequency control: Default setpoint source	Frequency preset 1 [11]
0x2911:001 (P450.01)	Frequency setpoint presets: Preset 1	40 Hz
0x2B84:001 (P704.01)	Current	50 %
0x2B84:002 (P704.02)	Automatic hold time	10 s
0x2B84:003 (P704.03)	Automatic operating threshold	15 Hz

1585 GB 09 18

### Input signals

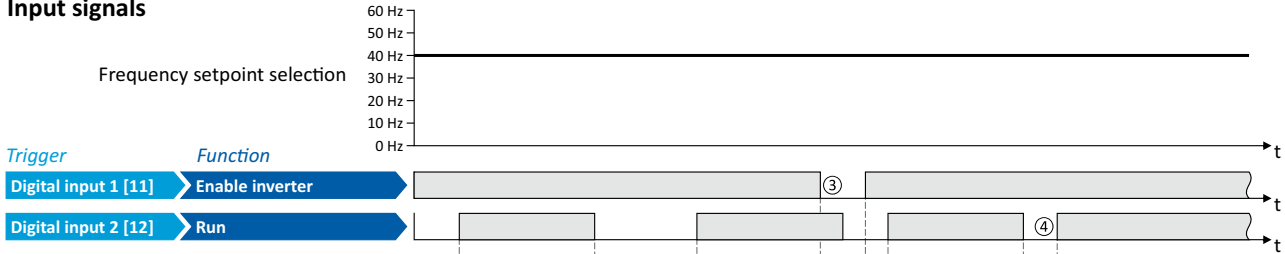

### Output signals

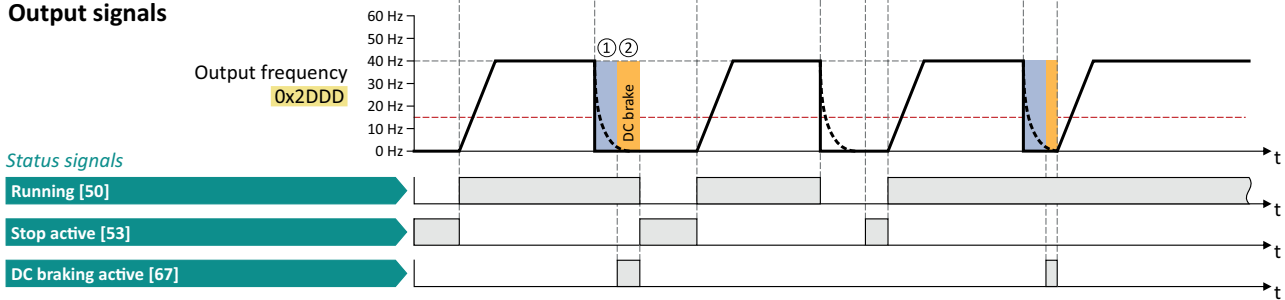

The status signals can be assigned to digital outputs. ► See chapter "Configuration of digital outputs".

- ① With the stop method "Coasting [0]", the motor first coasts for a specified time. This "demagnetising time" serves to reduce the induced voltage.
- ② The DC braking becomes active for the hold time set in 0x2B84:002 (P704.02).
- ③ If the variable speed drive is disabled, the motor coasts. (DC braking is only possible if the variable speed drive is enabled.)
- ④ If there is a new start command within the hold time, the DC braking is cancelled. The motor is accelerated to the setpoint again.

### 10.5 BRAKE ENERGY MANAGEMENT

When braking electrical motors, the kinetic energy of the drive train is fed back regeneratively to the DC bus. This energy causes a DC-bus voltage boost. If the energy fed back is too high, the variable speed drive reports an error.

Several different strategies can serve to avoid DC-bus overvoltage:

- Stopping the deceleration ramp function generator when the active voltage threshold for the brake operation is exceeded
- Use of the "Inverter motor brake" function
- Combination of the above named options.

#### Details

The voltage threshold for braking operation results on the basis of the rated mains voltage :

Rated mains voltage	Voltage thresholds for braking operation	
	Braking operation on	Braking operation off
230 V	DC 390 V	DC 380 V

The voltage threshold for braking operation can be reduced by 0 ... 100 V. The reduction required must be set in 0x2541:003 (P706.03). However, the reduction must be made to such an extent that the reduced voltage threshold is still above the normal stationary DC-bus voltage. The active voltage threshold for the braking operation is displayed in 0x2541:002 (P706.02).

If the DC-bus voltage exceeds the voltage threshold for braking operation, the braking method selected in 0x2541:001 (P706.01) is applied.

- Stopping the deceleration ramp function generator enables smoother deceleration with lower torque oscillation.
- The "Inverter motor brake" function allows for quick braking. For process-related reasons, torque oscillations may occur.

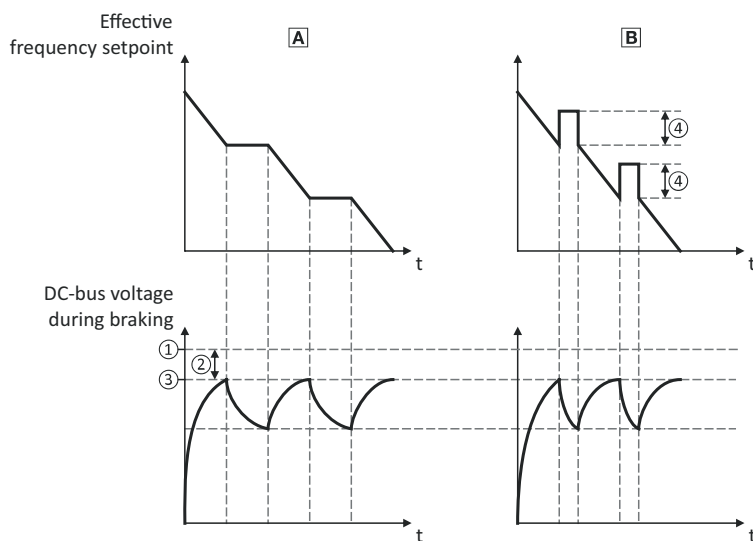

- ① Voltage threshold for braking operation
- ② Reduced threshold 0x2541:003 (P706.03)
- ③ Active threshold 0x2541:002 (P706.02)
- ④ Additional frequency 0x2541:004 (P706.04)

A See chapter "Stopping the deceleration ramp function generator"  
 B See chapter "Inverter motor brake"

Parameter	Name / value range / [default setting]	Info
0x2541:001 (P706.01)	Brake energy management: Operating mode (Brake management: Operating mode)	Selection of the braking method. – The braking method(s) selected is/are activated if the DC-bus voltage exceeds the voltage threshold for the braking operation shown in 0x2541:002 (P706.02).
	1 Ramp function generator stop (RFGS)	The deceleration ramp function generator is stopped. ► See chapter "Stopping the deceleration ramp function generator".
	3 Inverter motor brake (IMB) + RFGS	Braking with the "Inverter motor brake" braking method in connection with "Deceleration ramp function generator stop" is executed. ► See chapter "Inverter motor brake".
0x2541:002 (P706.02)	Brake energy management: Active threshold (Brake management: Active threshold) – Read only: x V	Display of the active voltage threshold for the braking operation. – The voltage threshold shown depends on the mains voltage selected in 0x2540:001 (P208.01) and the voltage value set in 0x2541:003 (P706.03). – The voltage threshold must be higher than the stationary DC voltage in the DC bus.
0x2541:003 (P706.03)	Brake energy management: Reduced threshold (Brake management: Red. threshold) 0 ... [0] ... 100 V	The voltage threshold for the braking operation is reduced by the voltage value set here.
0x2541:005 (P706.05)	Brake energy management: Deceleration override time (Brake management: Del. overr. time) 0.0 ... [2.0] ... 60.0 s	Maximum permissible time for the deceleration override by means of the braking method selected in 0x2541:001 (P706.01). – If the DC-bus voltage does not fall below the voltage threshold for braking operation shown in 0x2541:002 (P706.02) within this time the motor is decelerated further. – The time is only reset if the voltage threshold shown in 0x2541:002 (P706.02) is not reached.
0x2540:001 (P208.01)	Mains settings: Rated mains voltage (Mains settings: Mains voltage) – Setting can only be changed if the variable speed drive is inhibited.	Selection of the mains voltage for actuating the variable speed drive. Note. For VLA1 the only permissible setting is [0] 230Veff.
	0 230 Veff	
	1 400 Veff	
	2 480 Veff	
	3 120 Veff	

#### 10.5.1 STOPPING THE DECELERATION RAMP FUNCTION GENERATOR

The deceleration ramp function generator is stopped for a short time if the voltage threshold for braking operation is exceeded.

##### Details

When this braking method is selected, the maximum permissible time for the deceleration override has to be set in 0x2541:005 (P706.05).

- If the DC-bus voltage does not fall below the voltage threshold for braking operation shown in 0x2541:002 (P706.02) within this time, the motor is decelerated further.
- The time is only reset if the voltage threshold shown in 0x2541:002 (P706.02) is not reached.

### 10.5.2 INVERTER MOTOR BRAKE

With this braking method, which can be selected in 0x2541:001 (P706.01), the regenerative energy in the motor is converted as a result of dynamic acceleration/deceleration with down-ramping of the ramp function generator.

#### NOTICE

Too frequent braking may cause thermal overload of the motor.

- ▶ Avoid activating the "Inverter motor brake" function over a longer time!
- ▶ In applications with a high mass inertia and long braking time (> 2 s), use the "DC braking" function

#### Preconditions

- The "Inverter motor brake" braking method must not be used with vertical conveyors (hoists) or with active loads!
- The "inverter motor brake" braking method only works in operating mode 0x6060 (P301.00) = "MS: Velocity mode [-2]".
- When this braking method is used, the motor overload monitoring is not adapted. A too frequent use of the inverter motor brake may cause an incorrect operation of the motor overload monitoring.
  - ▶ See chapter "Motor overload monitoring ( $i^2 \cdot t$ )".

#### Details

During the deceleration process, the ramp function generator is stopped. The frequency set in 0x2541:004 (P706.04) is added to the frequency setpoint, taking the sign of the current actual frequency into consideration. Furthermore the ramp function generator is stopped in a state of overvoltage. If the DC-bus voltage falls below a defined DC-bus voltage potential, the additional frequency connected is reduced again and the ramp function generator is re-activated.

By the alternating acceleration and deceleration resulting from this circuit, the energy is converted thermally in the motor. For process-related reasons, torque oscillations may occur.

#### Setting instruction

Generally, the smallest value possible required by the application for being able to still traverse the load to be moved in a controlled fashion should be set as additional frequency. Greater mass inertia values require an increase in the rated motor frequency set. Increasing the rated motor frequency, however, causes greater torque oscillations. A possible consequence is the reduced service life of mechanical components. Furthermore an increase in the rated motor frequency also increases the energy converted into heat in the motor. A possible consequence is the reduced service life of the motor.

Parameter	Name / value range / [default setting]	Info
0x2541:004 (P706.04)	Brake energy management: Additional frequency (Brake management: Add.frequency) 0.0 ... [0.0] ... 10.0 Hz	Frequency deviation which is connected to the deceleration ramp in a pulsative fashion when the "Inverter motor brake" braking method is used.
0x2C01:005 (P320.05)	Motor parameters: Rated frequency (Motor parameters: Rated frequency) Device for 50-Hz mains: 1.0 ... [50.0] ... 1000.0 Hz Device for 60-Hz mains: 1.0 ... [60.0] ... 1000.0 Hz	General motor data. Carry out setting as specified by motor nameplate data.  Note! When you enter the motor nameplate data, take into account the phase connectin implemented for the motor (star or delta connection). Only enter the data applying to the connection type selected.
0x6060 (P301.00)	Modes of operation (Modes of op.) – Setting can only be changed if the variable speed drive is inhibited.	Selection of the operating mode.
	-2 MS: Velocity mode	Vendor specific velocity mode.
	-1 MS: Torque mode	Vendor specific torque mode. – Only possible in motor control type 0x2C00 (P300.00) = "Sensorless vector control (SLVC) [4]". ▶ See chapter "Torque control w/ freq. limit".
0	No mode change/no mode assigned	No operating mode (standstill).

### 10.6 LOAD LOSS DETECTION

This function serves to detect a load loss during operation and to then activate a specific function, for instance the switching of the relay.

#### Details

If, during operation, the current motor current falls below the threshold set in 0x4006:001 (P710.01) for at least the time set in 0x4006:002 (P710.02), the internal status signal "Load loss detected [83]" is set to TRUE:

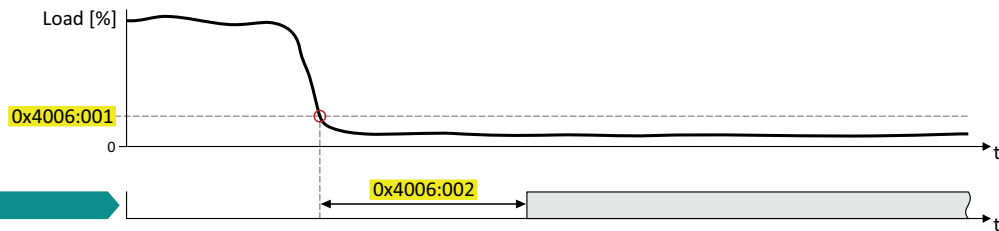

#### Status signal

Load loss detected [83]

- The threshold is set in percent with reference to the rated motor current "Motor rated current" 0x6075 (P323.00).
- The status signal "Load loss detected [83]" can be assigned, for instance, to a digital output or the relay via the flexible I/O configuration. ▶ See chapter "Configuration of digital outputs".
- The load loss detection is not active with active DC braking.

Parameter	Name / value range / [default setting]	Info
0x4006:001 (P710.01)	Load loss detection Threshold (Load loss detect: Threshold) 0.0 ... [0.0] ... 200.0 %	Threshold for load loss detection. – 100 % $\equiv$ rated motor current 0x6075 (P323.00)
0x4006:002 (P710.02)	Load loss detection: Delay time (Load loss detect: Delay time) 0.0 ... [0.0] ... 300.0 s	Tripping delay for load loss detection.
0x6075 (P323.00)	Motor rated current (Motor current) 0.001 ... [1.700]* ... 500.000 A *Default setting depending on the size. – Setting can only be changed if the variable speed drive is inhibited.	The rated motor current to be set here serves as a reference value for different parameters with a setting/display of a current value in percent. Example: – Motor rated current = 1.7 A – Max current 0x6073 (P324.00) = 200 % Motor rated current = 3.4 A
0x6078 (P103.00)	Current actual value (Current actual) – Read only: x.x %	Display of the present motor current. – 100 % $\equiv$ Motor rated current 0x6075 (P323.00)



## 10.8 FAVORITES

In order to gain quick access using VLBX SW software or the keypad, frequently used parameters of the variable speed drive can be defined as "Favorites".

- VLBX SW software provides quick access to the "Favorites" via the Favorites tab.
- On the keypad, the "Favorites" can be found in Group 0.

### 10.8.1 ACCESSING THE "FAVORITES" WITH THE KEYPAD

1585 GB 09 18

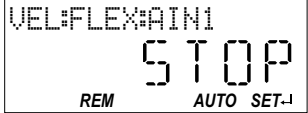
- 

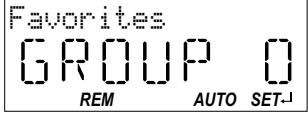
1. VEL:FLEX:AIN1  
STOP  
REM AUTO SET-I
- 

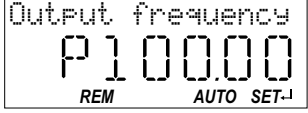
2. Favorites  
GROUP 0  
REM AUTO SET-I
- 

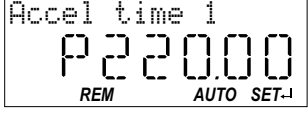
3. Output frequency  
P100.00  
REM AUTO SET-I
- 

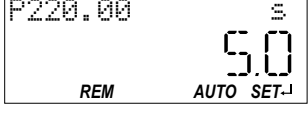
4. Accel time 1  
P220.00  
REM AUTO SET-I
- 

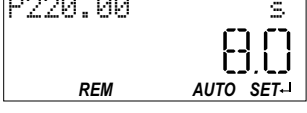
5. P220.00 5.0  
REM AUTO SET-I
- 

6. P220.00 8.0  
REM AUTO SET-I

1. Use the  $\leftarrow$  key in the operating mode to navigate to the parameterisation mode one level below.  
You are now in the group level. All parameters of the VLA1 are divided into different groups according to their function.  
Group 0 contains the "Favorites".  
Note: By using the  $\rightarrow$  key you can navigate one level upwards again anytime.
2. Use the  $\leftarrow$  key to navigate to one level below.  
You are now in the parameter level of the group selected.
3. Use the  $\uparrow$  and  $\downarrow$  navigation keys to select the desired parameter.
4. Use the  $\leftarrow$  key to navigate to one level below. You are now in the editing mode.
5. Set the desired value using the  $\uparrow$  and  $\downarrow$  navigation keys.
6. Use the  $\leftarrow$  key to accept the changed setting. The editing mode is exited.  
Note: By using the  $\rightarrow$  key you can exit the editing mode without accepting the new setting (abort).

## 10.8.2 FAVORITES PARAMETER LIST (DEFAULT SETTING)

In the default setting the most common parameters for the solution of typical applications are defined as "Favorites":

No.	Display code	Designation	Default setting	Setting range	Info
1	P100.00	Output frequency	x.x Hz	- (Read only)	0x2DDD (P100.00)
2	P103.00	Current actual	x.x %	- (Read only)	0x6078 (P103.00)
3	P106.00	Motor voltage	x VAC	- (Read only)	0x2D89 (P106.00)
4	P150.00	Error code	-	- (Read only)	0x603F (P150.00)
5	P200.00	Control select.	Flexible I/O [0]	Selection list	0x2824 (P200.00)
6	P201.01	Freq. setp. src.	Analog input 1 [2]	Selection list	0x2860:001 (P201.01)
7	P203.01	Start method	Normal [0]	Selection list	0x2838:001 (P203.01)
8	P203.03	Stop method	Standard ramp [1]	Selection list	0x2838:003 (P203.03)
9	P208.01	Mains voltage	230 Veff [0]	Selection list	0x2540:001 (P208.01)
10	P210.00	Min. frequency	0.0 Hz	0.0 ... 599.0 Hz	0x2915 (P210.00)
11	P211.00	Max. frequency	50.0 Hz*   60.0 Hz**	0.0 ... 599.0 Hz	0x2916 (P211.00)
12	P220.00	Accelerat.time 1	5.0 s	0.0 ... 3600.0 s	0x2917 (P220.00)
13	P221.00	Decelerat.time 1	5.0 s	0.0 ... 3600.0 s	0x2918 (P221.00)
14	P300.00	Motor ctrl mode	VFC open loop [6]	Selection list	0x2C00 (P300.00)
15	P302.00	V/f charac.shape	Linear [0]	Selection list	0x2B00 (P302.00)
16	P303.01	Base voltage	230 V	0 ... 5000 V	0x2B01:001 (P303.01)
17	P303.02	Base frequency	50 Hz*   60 Hz**	0 ... 1500 Hz	0x2B01:002 (P303.02)
18	P304.00	Limit. rotation	Both rot. direct [1]	Selection list	0x283A (P304.00)
19	P305.00	Switching freq.	0	Selection list	0x2939 (P305.00)
20	P308.01	Max.load.for 60s	150 %	30 ... 200 %	0x2D4B:001 (P308.01)
21	P316.01	Fixed V/f boost	2.5 %	0.0 ... 20.0 %	0x2B12:001 (P316.01)
22	P323.00	Motor current	1.700 A	0.001 ... 500.000 A	0x6075 (P323.00)
23	P324.00	Max current	200.0 %	0.0 ... 3000.0 %	0x6073 (P324.00)
24	P400.01	Enable inverter	TRUE [1]	Selection list	0x2631:001 (P400.01)
25	P400.02	Run	Digital input 1 [11]	Selection list	0x2631:002 (P400.02)
26	P400.03	Quick stop	Not connected [0]	Selection list	0x2631:003 (P400.03)
27	P400.04	Reset fault	Digital input 2 [12]	Selection list	0x2631:004 (P400.04)
28	P400.05	DC braking	Not connected [0]	Selection list	0x2631:005 (P400.05)
33	P400.13	Reverse rot.dir.	Digital input 3 [13]	Selection list	0x2631:013 (P400.13)
34	P400.18	Setp: Preset b0	Digital input 4 [14]	Selection list	0x2631:018 (P400.18)
35	P400.19	Setp: Preset b1	Digital input 5 [15]	Selection list	0x2631:019 (P400.19)
36	P400.20	Setp: Preset b2	Not connected [0]	Selection list	0x2631:020 (P400.20)
37	P420.01	Relay function	Rdy for operat. [51]	Selection list	0x2634:001 (P420.01)
38	P420.02	DO1 function	Release brake [115]	Selection list	0x2634:002 (P420.02)
39	P430.01	AI1 input range	0 ... 10 VDC [0]	Selection list	0x2636:001 (P430.01)
40	P430.02	AI1 freq @ min	0.0 Hz	-1000.0 ... 1000.0 Hz	0x2636:002 (P430.02)
41	P430.03	AI1 freq @ max	50.0 Hz*   60.0 Hz**	-1000.0 ... 1000.0 Hz	0x2636:003 (P430.03)
42	P440.01	AO1 outp. range	0 ... 10 VDC [1]	Selection list	0x2639:001 (P440.01)
43	P440.02	AO1 function	Outp. frequency [1]	Selection list	0x2639:002 (P440.02)
44	P440.03	AO1 min. signal	0	-2147483648 ... 2147483647	0x2639:003 (P440.03)
45	P440.04	AO1 max. signal	1000	-2147483648 ... 2147483647	0x2639:004 (P440.04)
46	P450.01	Freq. preset 1	20.0 Hz	0.0 ... 599.0 Hz	0x2911:001 (P450.01)
47	P450.02	Freq. preset 2	40.0 Hz	0.0 ... 599.0 Hz	0x2911:002 (P450.02)
48	P450.03	Freq. preset 3	50.0 Hz*   60.0 Hz**	0.0 ... 599.0 Hz	0x2911:003 (P450.03)
49	P450.04	Freq. preset 4	0.0 Hz	0.0 ... 599.0 Hz	0x2911:004 (P450.04)
50	-	-	-	-	not assigned

\* Device for 50-Hz mains \*\* Device for 60-Hz mains

### 10.8.3 CONFIGURING THE "FAVORITES"

The "Favorites" can be configured by the user.

#### Details

A maximum number of 50 parameters can be defined as "Favorites".

The easiest way to process the selection of the favorites is via the parameterisation dialog in the VLBX SW software.

1. Change to the "Parameter list" tab.
2. Select group 0 - Favorites.
3. Click the  button
4. Process favorites:

1585 GB 09 18

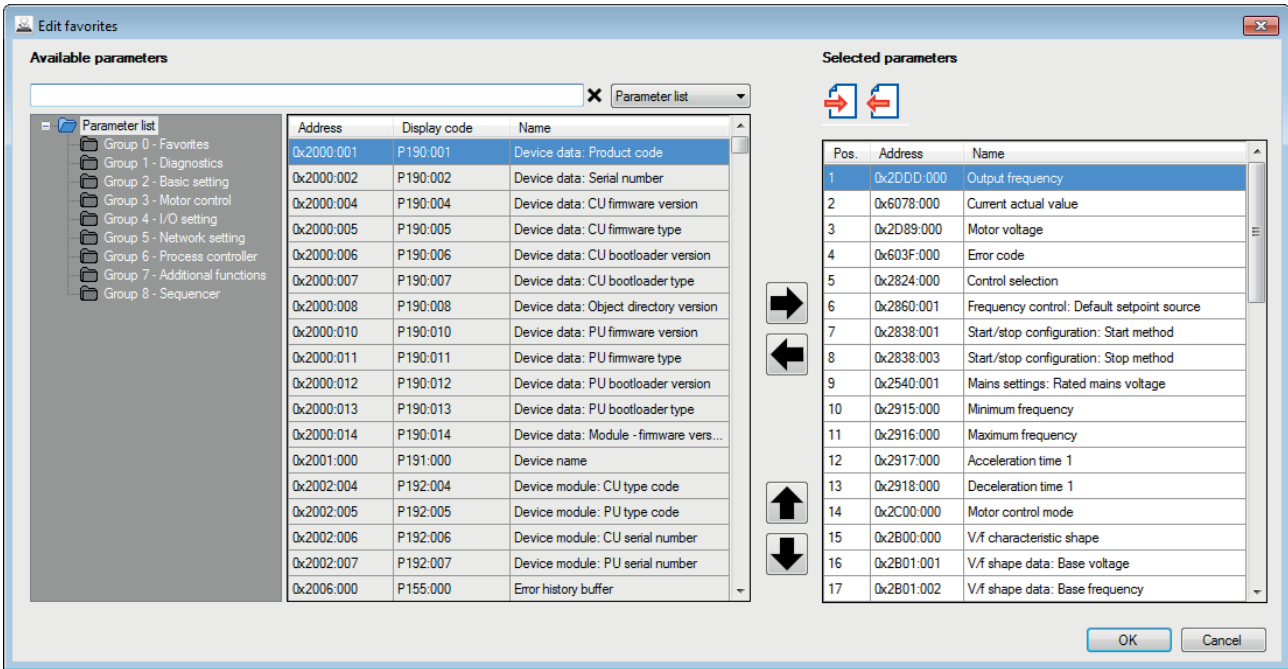

Default favorites can be changed with the keypad via the following parameters:

Parameter	Name / value range / [default setting]	Info
0x261C:001 (P740.01)	Favorites settings: Parameter 1 (Favorites sett.: Parameter 1) 0x00000000 ... [0x2DDD0000] ... 0xFFFFFFFF00	Definition of the "Favorites" parameters. – Format: 0xiiii00 (iiii = hexadecimal index, ss = hexadecimal subindex) – The lowest byte is always 0x00. – The keypad can be used to select the desired parameter from a list.
0x261C:002 (P740.02)	Favorites settings: Parameter 2 (Favorites sett.: Parameter 2) 0x00000000 ... [0x60780000] ... 0xFFFFFFFF00	
0x261C:003 (P740.03)	Favorites settings: Parameter 3 (Favorites sett.: Parameter 3) 0x00000000 ... [0x2D890000] ... 0xFFFFFFFF00	
0x261C:004 (P740.04)	Favorites settings: Parameter 4 (Favorites sett.: Parameter 4) 0x00000000 ... [0x603F0000] ... 0xFFFFFFFF00	
0x261C:005 (P740.05)	Favorites settings: Parameter 5 (Favorites sett.: Parameter 5) 0x00000000 ... [0x28240000] ... 0xFFFFFFFF00	
0x261C:006 (P740.06)	Favorites settings: Parameter 6 (Favorites sett.: Parameter 6) 0x00000000 ... [0x28600100] ... 0xFFFFFFFF00	
0x261C:007 (P740.07)	Favorites settings: Parameter 7 (Favorites sett.: Parameter 7) 0x00000000 ... [0x28380100] ... 0xFFFFFFFF00	
0x261C:008 (P740.08)	Favorites settings: Parameter 8 (Favorites sett.: Parameter 8) 0x00000000 ... [0x28380300] ... 0xFFFFFFFF00	
0x261C:009 (P740.09)	Favorites settings: Parameter 9 (Favorites sett.: Parameter 9) 0x00000000 ... [0x25400100] ... 0xFFFFFFFF00	
0x261C:010 (P740.10)	Favorites settings: Parameter 10 (Favorites sett.: Parameter 10) 0x00000000 ... [0x29150000] ... 0xFFFFFFFF00	
0x261C:011 (P740.11)	Favorites settings: Parameter 11 (Favorites sett.: Parameter 11) 0x00000000 ... [0x29160000] ... 0xFFFFFFFF00	
0x261C:012 (P740.12)	Favorites settings: Parameter 12 (Favorites sett.: Parameter 12) 0x00000000 ... [0x29170000] ... 0xFFFFFFFF00	
0x261C:013 (P740.13)	Favorites settings: Parameter 13 (Favorites sett.: Parameter 13) 0x00000000 ... [0x29180000] ... 0xFFFFFFFF00	

Parameter	Name / value range / [default setting]	Info
0x261C:014 (P740.14)	Favorites settings: Parameter 14 (Favorites sett.: Parameter 14) 0x00000000 ... [0x2C000000] ... 0xFFFFFFFF00	
0x261C:015 (P740.15)	Favorites settings: Parameter 15 (Favorites sett.: Parameter 15) 0x00000000 ... [0x2B000000] ... 0xFFFFFFFF00	
0x261C:016 (P740.16)	Favorites settings: Parameter 16 (Favorites sett.: Parameter 16) 0x00000000 ... [0x2B010100] ... 0xFFFFFFFF00	
0x261C:017 (P740.17)	Favorites settings: Parameter 17 (Favorites sett.: Parameter 17) 0x00000000 ... [0x2B010200] ... 0xFFFFFFFF00	
0x261C:018 (P740.18)	Favorites settings: Parameter 18 (Favorites sett.: Parameter 18) 0x00000000 ... [0x283A0000] ... 0xFFFFFFFF00	
0x261C:019 (P740.19)	Favorites settings: Parameter 19 (Favorites sett.: Parameter 19) 0x00000000 ... [0x29390000] ... 0xFFFFFFFF00	
0x261C:020 (P740.20)	Favorites settings: Parameter 20 (Favorites sett.: Parameter 20) 0x00000000 ... [0x2D4B0100] ... 0xFFFFFFFF00	
0x261C:021 (P740.21)	Favorites settings: Parameter 21 (Favorites sett.: Parameter 21) 0x00000000 ... [0x2B120100] ... 0xFFFFFFFF00	
0x261C:022 (P740.22)	Favorites settings: Parameter 22 (Favorites sett.: Parameter 22) 0x00000000 ... [0x60750000] ... 0xFFFFFFFF00	
0x261C:023 (P740.23)	Favorites settings: Parameter 23 (Favorites sett.: Parameter 23) 0x00000000 ... [0x60730000] ... 0xFFFFFFFF00	
0x261C:024 (P740.24)	Favorites settings: Parameter 24 (Favorites sett.: Parameter 24) 0x00000000 ... [0x26310100] ... 0xFFFFFFFF00	
0x261C:025 (P740.25)	Favorites settings: Parameter 25 (Favorites sett.: Parameter 25) 0x00000000 ... [0x26310200] ... 0xFFFFFFFF00	
0x261C:026 (P740.26)	Favorites settings: Parameter 26 (Favorites sett.: Parameter 26) 0x00000000 ... [0x26310300] ... 0xFFFFFFFF00	
0x261C:027 (P740.27)	Favorites settings: Parameter 27 (Favorites sett.: Parameter 27) 0x00000000 ... [0x26310400] ... 0xFFFFFFFF00	
0x261C:028 (P740.28)	Favorites settings: Parameter 28 (Favorites sett.: Parameter 28) 0x00000000 ... [0x26310500] ... 0xFFFFFFFF00	
0x261C:029 (P740.29)	Favorites settings: Parameter 29 (Favorites sett.: Parameter 29) 0x00000000 ... [0x26310600] ... 0xFFFFFFFF00	
0x261C:030 (P740.30)	Favorites settings: Parameter 30 (Favorites sett.: Parameter 30) 0x00000000 ... [0x26310700] ... 0xFFFFFFFF00	
0x261C:031 (P740.31)	Favorites settings: Parameter 31 (Favorites sett.: Parameter 31) 0x00000000 ... [0x26310800] ... 0xFFFFFFFF00	
0x261C:032 (P740.32)	Favorites settings: Parameter 32 (Favorites sett.: Parameter 32) 0x00000000 ... [0x26310900] ... 0xFFFFFFFF00	
0x261C:033 (P740.33)	Favorites settings: Parameter 33 (Favorites sett.: Parameter 33) 0x00000000 ... [0x26310D00] ... 0xFFFFFFFF00	
0x261C:034 (P740.34)	Favorites settings: Parameter 34 (Favorites sett.: Parameter 34) 0x00000000 ... [0x26311200] ... 0xFFFFFFFF00	
0x261C:035 (P740.35)	Favorites settings: Parameter 35 (Favorites sett.: Parameter 35) 0x00000000 ... [0x26311300] ... 0xFFFFFFFF00	
0x261C:036 (P740.36)	Favorites settings: Parameter 36 (Favorites sett.: Parameter 36) 0x00000000 ... [0x26311400] ... 0xFFFFFFFF00	
0x261C:037 (P740.37)	Favorites settings: Parameter 37 (Favorites sett.: Parameter 37) 0x00000000 ... [0x26340100] ... 0xFFFFFFFF00	
0x261C:038 (P740.38)	Favorites settings: Parameter 38 (Favorites sett.: Parameter 38) 0x00000000 ... [0x26340200] ... 0xFFFFFFFF00	
0x261C:039 (P740.39)	Favorites settings: Parameter 39 (Favorites sett.: Parameter 39) 0x00000000 ... [0x26360100] ... 0xFFFFFFFF00	

Parameter	Name / value range / [default setting]	Info
0x261C:040 (P740.40)	Favorites settings: Parameter 40 (Favorites sett.: Parameter 40) 0x00000000 ... [0x26360200] ... 0xFFFFFFFF00	
0x261C:041 (P740.41)	Favorites settings: Parameter 41 (Favorites sett.: Parameter 41) 0x00000000 ... [0x26360300] ... 0xFFFFFFFF00	
0x261C:042 (P740.42)	Favorites settings: Parameter 42 (Favorites sett.: Parameter 42) 0x00000000 ... [0x26390100] ... 0xFFFFFFFF00	
0x261C:043 (P740.43)	Favorites settings: Parameter 43 (Favorites sett.: Parameter 43) 0x00000000 ... [0x26390200] ... 0xFFFFFFFF00	
0x261C:044 (P740.44)	Favorites settings: Parameter 44 (Favorites sett.: Parameter 44) 0x00000000 ... [0x26390300] ... 0xFFFFFFFF00	
0x261C:045 (P740.45)	Favorites settings: Parameter 45 (Favorites sett.: Parameter 45) 0x00000000 ... [0x26390400] ... 0xFFFFFFFF00	
0x261C:046 (P740.46)	Favorites settings: Parameter 46 (Favorites sett.: Parameter 46) 0x00000000 ... [0x29110100] ... 0xFFFFFFFF00	
0x261C:047 (P740.47)	Favorites settings: Parameter 47 (Favorites sett.: Parameter 47) 0x00000000 ... [0x29110200] ... 0xFFFFFFFF00	
0x261C:048 (P740.48)	Favorites settings: Parameter 48 (Favorites sett.: Parameter 48) 0x00000000 ... [0x29110300] ... 0xFFFFFFFF00	
0x261C:049 (P740.49)	Favorites settings: Parameter 49 (Favorites sett.: Parameter 49) 0x00000000 ... [0x29110400] ... 0xFFFFFFFF00	
0x261C:050 (P740.50)	Favorites settings: Parameter 50 (Favorites sett.: Parameter 50) 0x00000000 ... [0x00000000] ... 0xFFFFFFFF00	

### 10.9 PARAMETER CHANGE-OVER

For up to 32 freely selectable parameters, this function provides a change-over between four sets with different parameter values.

#### DANGER!

Changed parameter settings are effective immediately.

The possible consequence is an unexpected response of the motor shaft while the variable speed drive is enabled.

- ▶ If possible, only carry out parameter changes while the variable speed drive is disabled.
- ▶ Certain device commands or settings which might cause a critical state of the drive behaviour can generally only be carried out when the variable speed drive is inhibited.

#### Details

The parameter list is compiled in the same way as that of the "Favorites" via configuration. VLBX SW provides a user-friendly parameterisation dialog for this purpose.

Change-over to another value set can optionally be effected via corresponding device commands and/or special functions/triggers:

- ▶ See chapter "Device commands for parameter change-over"
- ▶ See chapter "Functions for parameter change-over"

Parameter	Name / value range / [default setting]	Info
0x2022:011 (P700.11)	Device commands: Save parameter set 1 (Device commands: Save par. set 1) – For further possible settings, see parameter 0x2022:001 (P700.01).  <b>0 Off / ready</b>	1 = save value set 1 of the "Parameter change-over" function. – When the device command has been executed successfully, the value 0 is shown.
0x2022:012 (P700.12)	Device commands: Save parameter set 2 (Device commands: Save par. set 2) – For further possible settings, see parameter 0x2022:001 (P700.01).  <b>0 Off / ready</b>	1 = save value set 2 of the "Parameter change-over" function. – When the device command has been executed successfully, the value 0 is shown.
0x2022:013 (P700.13)	Device commands: Save parameter set 3 (Device commands: Save par. set 3) – For further possible settings, see parameter 0x2022:001 (P700.01).  <b>0 Off / ready</b>	1 = save value set 3 of the "Parameter change-over" function. – When the device command has been executed successfully, the value 0 is shown.
0x2022:014 (P700.14)	Device commands: Save parameter set 4 (Device commands: Save par. set 4) – For further possible settings, see parameter 0x2022:001 (P700.01).  <b>0 Off / ready</b>	
0x4041:001 ... 0x4041:032 (P750.01 ... 32)	Parameter change-over: Parameter 1 ... Parameter 32 (Param.set setup: Parameter 1 ... Parameter 32) 0x00000000 ... [0x00000000] ... 0xFFFFFFFF00	Definition of the parameter list for the "Parameter change-over" function. – Format: Oxiiii00 (iiii = hexadecimal index, ss = hexadecimal subindex) – The lowest byte is always 0x00.
0x4042:001 ... 0x4042:032 (P751.01 ... 32)	Parameter value set 1: Value of parameter 1 ... Value of parameter 32 (Par. value set 1: Set 1 - Value 1 ... Set 1 - Value 32) -2147483648 ... [0] ... 2147483647	Value set 1 for the parameter list defined in 0x4041:001 ... 0x4041:032 (P750.01 ... 32).

Parameter	Name / value range / [default setting]	Info
0x4043:001 ... 0x4043:032 (P752.01 ... 32)	Parameter value set 2: Value of parameter 1 ... Value of parameter 32 (Par. value set 2: Set 2 - Value 1 ... Set 2 - Value 32) -2147483648 ... [0] ... 2147483647	Value set 2 for the parameter list defined in 0x4041:001 ... 0x4041:032 (P750.01 ... 32).
0x4044:001 ... 0x4044:032 (P753.01 ... 32)	Parameter value set 3: Value of parameter 1 ... Value of parameter 32 (Par. value set 3: Set 3 - Value 1 ... Set 3 - Value 32) -2147483648 ... [0] ... 2147483647	Value set 3 for the parameter list defined in 0x4041:001 ... 0x4041:032 (P750.01 ... 32).
0x4045:001 ... 0x4045:032 (P754.01 ... 32)	Parameter value set 4: Value of parameter 1 ... Value of parameter 32 (Par. value set 4: Set 4 - Value 1 ... Set 4 - Value 32) -2147483648 ... [0] ... 2147483647	Value set 4 for the parameter list defined in 0x4041:001 ... 0x4041:032 (P750.01 ... 32).
0x4046 (P755.00)	Activation of parameter set (PSet activation)	Selection of the activation method for the parameter change-over. – If the selection is changed from "Via command... [0]/[1]" to "If the selection is changed...[2]/[3]" after switch-on, the parameter set selected via the functions "Select parameter set (bit 0)" and "Select parameter set (bit 1)" is activated immediately. In case of selection [2], however, this only takes place if the variable speed drive is disabled, the motor is stopped or an error is active
	0 Via command (disable required)	The parameter set selected via the functions "Select parameter set (bit 0)" and "Select parameter set (bit 1)" is activated if the trigger assigned to the "Load parameter set" function in 0x2631:040 (P400.40) provides a FALSE-TRUE edge AND the variable speed drive is inhibited, the motor is stopped or an error is active.
	1 Via command (immediately)	The parameter set selected via the functions "Select parameter set (bit 0)" and "Select parameter set (bit 1)" is immediately activated if the trigger assigned to the "Load parameter set" function in 0x2631:040 (P400.40) provides a FALSE-TRUE edge.
	2 If the selection is changed (disable required)	The parameter set selected via the functions "Select parameter set (bit 0)" and "Select parameter set (bit 1)" is activated if the state of these selection bits changes AND the variable speed drive is inhibited, the motor is stopped or an error is active.
	3 If the selection is changed (immediately)	The parameter set selected via the functions "Select parameter set (bit 0)" and "Select parameter set (bit 1)" is activated immediately if the state of these selection bits is changed.
0x4047:001 (P756.01)	Parameter change-over error message: Status (PSet error msg.: Status) – Read only	Error message for the "parameter change-over" function. In the event of an error, an error status is shown here, and in 0x4047:002 (P756.02) the number of the list entry in which the error has occurred is displayed (in connection with the value set selected). – If several errors occur at the same time, only the first incorrect list entry will be displayed. Hence, after elimination of the displayed error and repeated activation, more errors may be displayed. – The parameter list will always be processed from beginning to end, even if errors occur in the meantime.
	0 No fault	
	33803 Invalid data type	
	33804 Range violation	
	33806 Invalid index	
	33813 No element selected	
	33815 Writing impermissible	
	33816 Device not inhibited	
	33829 Invalid subindex	
	33837 Access impermissible	
	33860 Parameter not mappable	
	33865 No subindexes	
	33876 Parameter not changeable	
0x4047:002 (P756.02)	Parameter change-over error message: List entry (PSet error msg.: List entry) – Read only	Error message for the "Parameter set changeover" function. – In the event of an error, the number of the list entry for which the error displayed in 0x4047:001 (P756.01) has occurred is shown here.
0x2631:040 (P400.40)	Function list: Load parameter set (Function list: Load param.set) – Setting can only be changed if the variable speed drive is inhibited. – For further possible settings, see parameter 0x2631:001 (P400.01).	Assignment of a trigger for the "Load parameter set" function. Trigger = FALSE-TRUE edge: parameter change-over to the value set selected via "Select parameter set (bit 0)" and "Select parameter set (bit 1)". Trigger = FALSE: no action. Notes: – The activation method for the "Parameter change-over" function can be selected in 0x4046 (P755.00).
	<b>0 Not connected</b>	
0x2631:041 (P400.41)	Function list: Select parameter set (bit 0) (Function list: Sel. paramset b0) – Setting can only be changed if the variable speed drive is inhibited. – For further possible settings, see parameter 0x2631:001 (P400.01).	Assignment of a trigger for the "Select parameter set (bit 0)" function. Selection bit with the valency 20 for "Parameter change-over" function. Trigger = FALSE: selection bit = "0". Trigger = TRUE: selection bit = "1".
	<b>0 Not connected</b>	
0x2631:042 (P400.42)	Function list: Select parameter set (bit 1) (Function list: Sel. paramset b1) – Setting can only be changed if the variable speed drive is inhibited. – For further possible settings, see parameter 0x2631:001 (P400.01).	Assignment of a trigger for the "Select parameter set (bit 1)" function. Selection bit with the valency 21 for "Parameter change-over" function. Trigger = FALSE: selection bit = "0". Trigger = TRUE: selection bit = "1".
	<b>0 Not connected</b>	

### 10.9.1 EXAMPLE: SELECTIVE CONTROL OF SEVERAL MOTORS WITH ONE VARIABLE SPEED DRIVE

A typical application for the parameter change-over is an application/machine in which several axes must be triggered successively but a simultaneous operation of several motors is not required. In this case, one and the same variable speed drive can trigger the motors in succession. Advantages of this solution are the reduced amount of components (variable speed drives) and thus a reduced energy consumption.

Principle:

- The motor to be currently controlled is connected to the variable speed drive via motor contactors.
- (The contactor system can, for instance, be controlled via the digital outputs of the variable speed drive.)
- At the same time, the motor and control setting suitable for motor are activated in the variable speed drive by means of parameter change-over.
- See chapter "Function for parameter change-over".

1585 GB 09 18

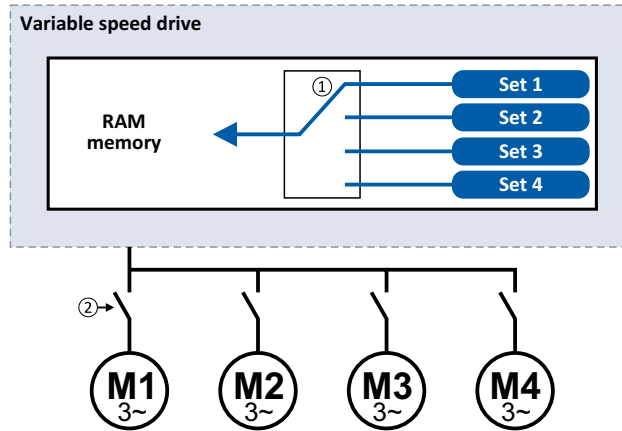

- ① Motor data change-over (via the "parameter change-over" function)
- ② Motor change-over (e.g. via motor contactors)

The following table lists all parameters that require different settings for the four motors:

#	Parameter	Name	Setting			
			M1	M2	M3	M4
1	0x2B00 (P302.00)	V/f characteristic shape	Linear [0]	Square-law [1]	Linear [0]	Linear [0]
2	0x2B01:002 (P303.02)	Base frequency	60 Hz	60 Hz	60 Hz	50 Hz
3	0x2D4B:001 (P308.01)	Maximum utilisation [60 s]	150 %	120 %	150 %	150 %
4	0x2B12:001 (P316.01)	Fixed boost	2.5 %	0.0 %	4.0 %	2.0 %
5	0x2C01:004 (P320.04)	Rated speed	1745	3450	1750	1450
6	0x2C01:005 (P320.05)	Rated frequency	60.0 Hz	60.0 Hz	60.0 Hz	50.0 Hz
7	0x2C01:006 (P320.06)	Rated power	0.75 kW	0.75 kW	0.75 kW	1.50 kW
8	0x2C01:007 (P320.07)	Rated voltage	230 V	230 V	230 V	230 V
9	0x6075 (P323.00)	Motor rated current	2,200 A	2,100 A	2,200 A	3,500 A
10	0x6073 (P324.00)	Max current	200.0 %	150.0 %	200.0 %	200.0 %

### 10.11 HOLDING BRAKE CONTROL

This function serves as a low-wear control of a holding brake. The holding is usually mounted to the motor as an option. The holding brake can be automatically released via the start command for the variable speed drive or manually via an external control signal, for instance, by a higher-level Controller. The interaction of higher-level Controller and holding brake is especially important for vertical applications. Horizontal applications need a less demanding holding brake control.

Preconditions

- Observe that the holding brake is an important element of the machine's safety concept as a whole. Therefore be sure to carry out commissioning of this system part with particular care!
- Holding brakes are not intended for braking during operation. The increased wear caused by braking during operation may destroy the holding brake prematurely!
- The holding brake control itself only outputs a digital trigger for releasing the holding brake. This trigger "Release holding brake [115]" must be assigned to a digital output or, in the simplest case, to the relay when then switches the brake supply.
  - See chapter "Configuration of digital outputs".
- If the holding brake is to be controlled via a digital output, the use of an additional relay or power contactor is required. The digital output is not suited for direct control of a holding brake.
- If, instead of an electrically releasing (self-holding) holding brake, an electrically holding (self-releasing) holding brake is to be controlled, a signal inversion for the digital output used or for the relay is to be set!
  - See chapter "Configuration of digital outputs".

Parameter	Name / value range / [default setting]	Info
0x2634:001 (P420.01)	Digital outputs function: Relay (Dig.out.function: Relay function) - For further possible settings see parameter 0x2634:001 (P420.01).	Assignment of a trigger to the relay. Trigger = FALSE: X9/NO-COM open and NC-COM closed. Trigger = TRUE: X9/NO-COM closed and NC-COM open. Notes: - An inversion set in 0x2635:001 (P421.01) is taken into consideration here.
<b>51</b>	<b>Ready for operation</b>	TRUE if variable speed drive is ready for operation (no error active, no STO active and DC-bus voltage ok). Otherwise FALSE.

### 10.11.1 BASIC SETTING

The following parameters must be set for the activation and basic setting of the holding brake control.

**i** When a power contactor is used, the response time and release time of the contactor are added to the brake application and release time. Both times must also be taken into consideration for parameterising the brake application time and brake opening time!

1585 GB 09 18

Parameter	Name / value range / [default setting]	Info
0x2820:001 (P712.01)	Holding brake control: Brake mode (Brake control: Brake mode)	Selecting how the "Release holding brake" command is to be triggered.
	0 Automatically (via device state)	"Automatic operation": The "Release holding brake" command is automatically carried out as a function of the device state and further conditions. <b>CAUTION!</b> Also in the automatic operation, a manual release of the holding brake is possible! For details see the following information for selection "Manually [1]".
	1 Manually	The "Release holding brake" command can also be initiated via the trigger assigned to the "Release holding brake" function in 0x2631:049 (P400.49) <b>CAUTION!</b> – The manually triggered "Release holding brake" command has a direct impact on the "Release holding brake [115]" trigger. Thus, the holding brake can be manually released if the power section is switched off! – The responsibility for a manual release of the holding brake has the external trigger source for the "Release holding brake" command!
	2 Off	The holding brake is deactivated.
0x2820:002 (P712.02)	Holding brake control: Brake closing time (Brake control: Closing time) 0 ... [100] ... 10000 ms	Application time (engagement time) of the holding brake. – Only effective in automatic operation.
0x2820:003 (P712.03)	Holding brake control: Brake opening time (Brake control: Opening time) 0 ... [100] ... 10000 ms	Release time (disengagement time) of the holding brake. – Only effective in automatic operation.
0x2820:015 (P712.15)	Holding brake control: Brake status (Brake control: Brake status) – Read only	Display of the holding brake status.
	0 Active	Holding brake is applied.
	1 Brake released	Holding brake is released.

For examples and details on more possible settings, see the following subchapter:

- "Automatic brake mode (automatic operation)
- Brake holding load
- Brake closing level
- Manual release of the holding brake.

### 10.11.2 "AUTOMATIC" BRAKE MODE (AUTOMATIC OPERATION)

In automatic operation the variable speed drive automatically released the holding brake when the motor is started. In the stopped state, the holding brake is closed.

**⚠ DANGER!**

Manual release of the holding brake.

Also in automatic operation a manual release of the holding brake is possible. The manually triggered "Release holding brake" command has a direct impact on the "Release holding brake [115]" trigger. Thus, the holding brake can be manually released if the power section is switched off.

- The responsibility for a manual release of the holding brake has the external trigger source for the "Release holding brake" command!

Preconditions

Automatic operation is only available if the operating mode "MS: Velocity mode [-2]" or "MS: Torque mode [-1]" is set in 0x6060 (P301.00).

Parameter	Name / value range / [default setting]	Info
0x6060 (P301.00)	Modes of operation (Modes of op.) – Setting can only be changed if the variable speed drive is inhibited.	Selection of the operating mode.
	-2 MS: Velocity mode	Vendor specific velocity mode.
	-1 MS: Torque mode	Vendor specific torque mode. – Only possible in motor control type 0x2C00 (P300.00) = "Sensorless vector control (SLVC) [4]". ▶ See chapter "Torque control w/ freq. limit".
	0 No mode change/no mode assigned	No operating mode (standstill).



General mode of operation

The following diagram demonstrates the general functioning of the automatic operation.

1585 GB 09 18

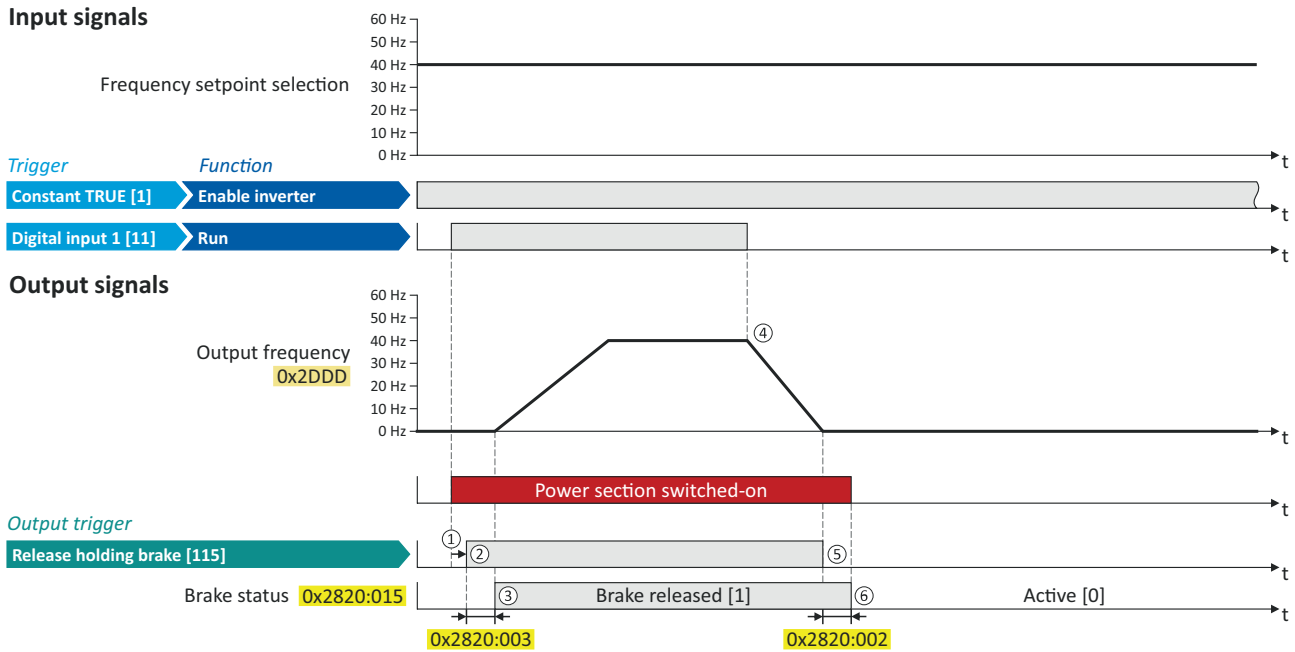

- ① If the variable speed drive is enabled and no error is active, the motor can be started with the "Run" function in forward rotating direction. The power section is switched on and the motor is magnetised first.
- ② The holding brake is released. For this purpose, the output trigger "Release holding brake [115]" is set to TRUE. This trigger must be assigned to a digital output or, in the simplest case, to the relay which then switches the brake supply.
- ③ After the release time 0x2820:003 (P712.03) has elapsed, the motor is accelerated to the setpoint. The brake status "Brake released [1]" is displayed in 0x2820:015 (P712.15).
- ④ If "Run" is set to FALSE, the motor is stopped with the stop method set in 0x2838:003 (P203.03). In the example: Stop with standard ramp.
- ⑤ Then the holding brake is closed again.
- ⑥ After the closing time 0x2820:002 (P712.02) has elapsed, the brake status "Active [0]" is displayed in 0x2820:015 (P712.15).

**i** If the power section is disabled, the holding brake is closed. Reasons for this can be an error or a fault.

### 10.11.3 BRAKE HOLDING LOAD

Depending on the application, a torque at the motor may be required at speed "0" of the motor shaft:

- In order to hold loads in vertical applications and prevent "sagging".
- In order to prevent a position loss in horizontal applications.

For this purpose, a brake holding load can be optionally generated via a ramp to reduce a vibration stimulation that may be caused by the brake holding load.

#### Preconditions

Ensure that the variable speed drive builds up a sufficient torque in the motor when releasing and applying the holding, in order to hold the load.

- For this purpose, a V/f voltage boost can be set for the V/f characteristic control. See chapter "V/f voltage boost".
- The parameters for the V/f voltage boost are automatically set when you carry out an automatic identification of the motor.

#### Details

Relevant parameters:

- 0x2820:008 (P712.08): Brake holding load
- 0x2820:013 (P712.13): Holding load ramp time

#### Setting notes:

- In case of applications with constant load, a constant value is suitable for the brake holding load.
- If the load constantly changes, an approximate value for the brake holding load has to be considered.
- Start with the setting "0 %" if you do not know the correct direction, otherwise with, for instance, "30 %". Afterwards change the setting upwards or downwards in 10-% steps.

Parameter	Name / value range / [default setting]	Info
0x2820:008 (P712.08)	Holding brake control: Brake holding load (Brake control: Holding load) -500.0 ... [0.0] ... 500.0 %	By setting a holding load, the load can be held against the force of gravity in case of vertical applications and a position loss can be prevented in case of horizontal applications. - The setting of "100 %" approximately corresponds to rated motor torque and slip frequency. <b>Note!</b> The torque for creating the holding load depends on the selected motor control type and its settings. Before using this function, make sure that you have set the motor control type correctly.
0x2820:013 (P712.13)	Holding brake control: Holding load ramp time (Brake control: HoldLoad ramp time) 0 ... [0] ... 100 ms	By setting a ramp time a vibration stimulation can be reduced that might be caused by the brake holding load 0x2820:008 (P712.08).

The following diagram demonstrates the general functioning in automatic operation.

### Input signals

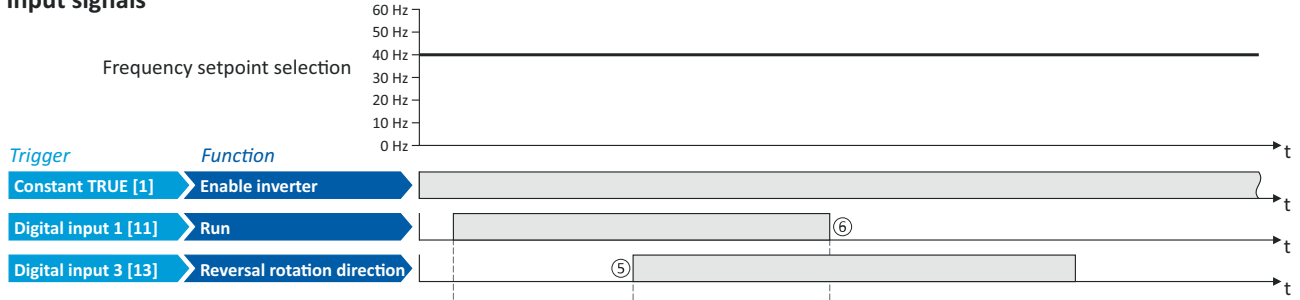

### Output signals

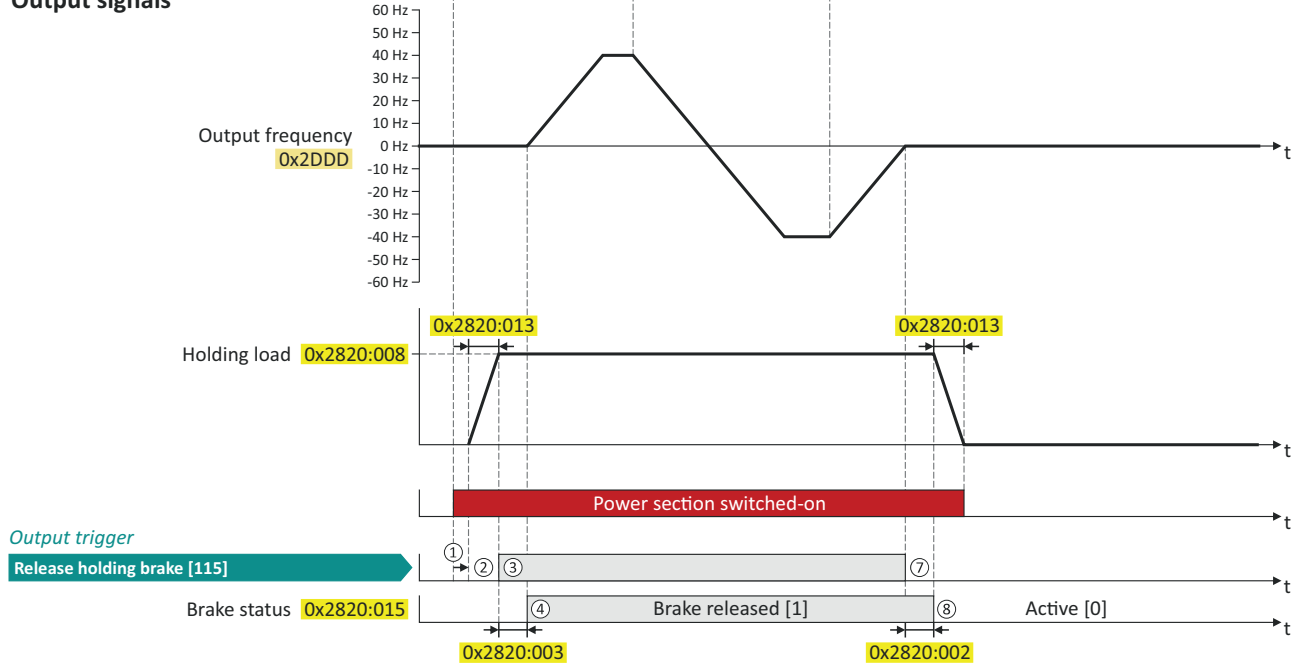

- ① If the variable speed drive is enabled and no error is active, the motor can be started with the "Run" function in forward rotating direction. The power section is switched on and the motor is magnetised first.
- ② The brake holding load set in 0x2820:008 (P712.08) is build up via the ramp set in 0x2820:013 (P712.13).
- ③ The holding brake is released. For this purpose, the output trigger "Release holding brake [115]" is set to TRUE. This trigger must be assigned to a digital output or, in the simplest case, to the relay which then switches the brake supply.
- ④ After the release time 0x2820:003 (P712.03) has elapsed, the motor is accelerated to the setpoint.  
The brake status "Brake released [1]" is displayed in 0x2820:015 (P712.15).
- ⑤ In case the direction of rotation reverses, the holding brake remains released.
- ⑥ If "Run" is set to FALSE, the motor is stopped with the stop method set in 0x2838:003 (P203.03). In the example: Stop with standard ramp.
- ⑦ Then the holding brake is closed again.
- ⑧ After the closing time 0x2820:002 (P712.02) has elapsed, the brake status "Active [0]" is displayed in 0x2820:015 (P712.15).  
The brake holding load is reduced again via the ramp.

#### 10.11.4 BRAKE CLOSING LEVEL

In some cases, a low speed does not make any sense from the application point of view. This includes applications with unfavorable load features, such as static friction. In such applications and depending on the type of control, a low speed may cause an unwanted behaviour. In order to prevent such an operating situation a closing threshold can be set. The power section will only be switched on and the holding brake is opened if the setpoint is higher than the closing threshold. In order to prevent the holding brake from being closed if the setpoint only shortly falls below the closing threshold during operation, a delay time can be set in addition.

#### Preconditions

If the holding brake is controlled manually via an external control signal: It must be ensured that the motor does not move while the motor control is deactivated by this function.

#### Details

The function is part of the holding brake control and does not have an independent functionality. Relevant parameters:

- 0x2820:007 (P712.07): Brake closing threshold
- 0x2820:012 (P712.12): Closing threshold delay

#### Setting notes:

- The function is active if the brake closing threshold is higher than 0 Hz.
- In order that the brake can work correctly, the brake closing threshold must be set to a value that is greater than or equals the minimum frequency 0x2915 (P210.00).
- The brake closing threshold has a permanent hysteresis of 1 Hz in order to prevent an unwanted change-over. Exception: If the brake closing threshold is set to 0 Hz, the hysteresis is also 0 Hz.
- If the brake closing threshold is set to 0 Hz, a start command is only required to release the holding brake during automatic operation.
- This function can be combined with the setting of a holding load.

Parameter	Name / value range / [default setting]	Info
0x2820:007 (P712.07)	Holding brake control: Brake closing threshold (Brake control: Closing thresh.) 0.0 ... [0.2] ... 599.0 Hz	Threshold for closing the holding brake. The power section will only be switched on and the holding brake will be opened if the setpoint is higher than the threshold set here. - In order that the brake can work correctly, the brake closing threshold must be set to a value that is greater than or equals the minimum frequency 0x2915 (P210.00). - The brake closing threshold has a permanent hysteresis of 1 Hz in order to prevent an unwanted change-over. Exception: If the brake closing threshold is set to 0 Hz, the hysteresis is also 0 Hz. - In case of a setting of "0 Hz", only a start command is required to release the holding break during automatic operation.
0x2820:012 (P712.12)	Holding brake control: Closing threshold delay (Brake control: ClosingThr delay) 0 ... [0] ... 10000 ms	By setting a deceleration a closing of the holding brake can be prevented if the frequency only temporarily falls below the brake closing threshold 0x2820:007 (P712.07).

#### General mode of operation

The following diagram demonstrates the general functioning in automatic operation.

#### Input signals

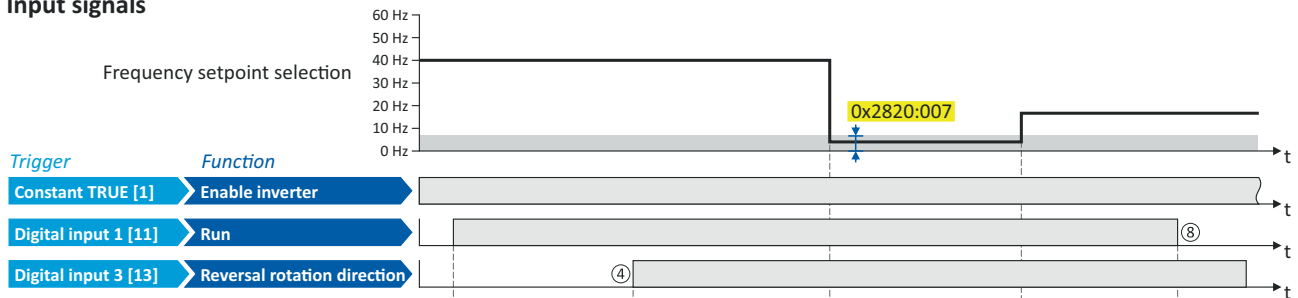

#### Output signals

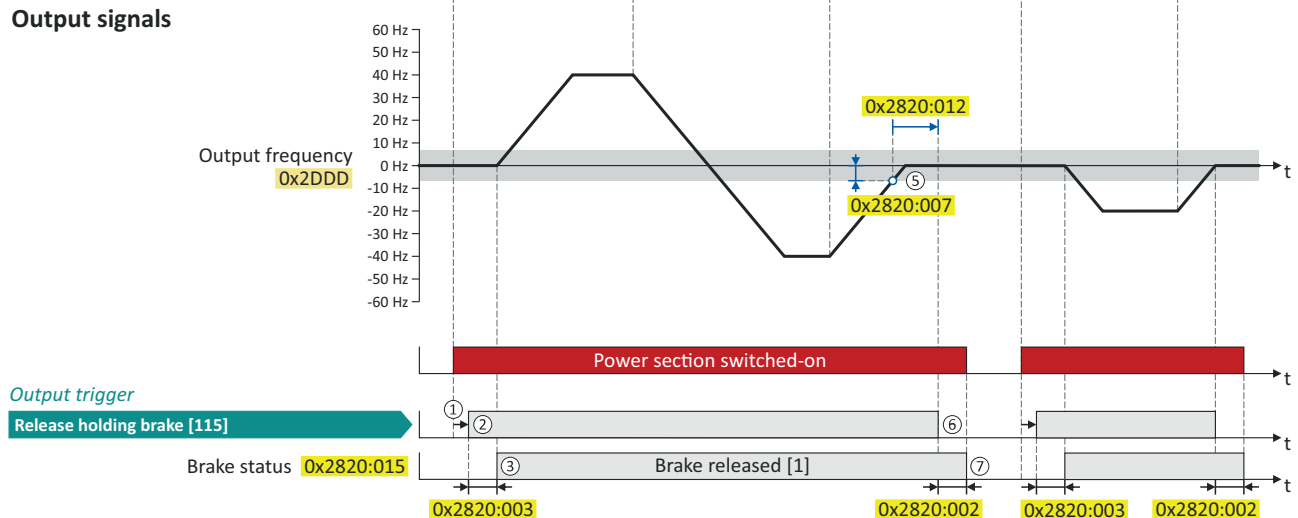

- ① If the variable speed drive is enabled and no error is active, the motor can be started with the "Run" function in forward rotating direction. The power section is switched on and the motor is magnetised first.
- ② The holding brake is released. For this purpose, the output trigger "Release holding brake [115]" is set to TRUE. This trigger must be assigned to a digital output or, in the simplest case, to the relay which then switches the brake supply.
- ③ After the release time 0x2820:003 (P712.03) has elapsed, the motor is accelerated to the setpoint. The brake status "Brake released [1]" is displayed in 0x2820:015 (P712.15).
- ④ If the direction of rotation reverses, the holding brake remains released (even if the closing threshold delay is running.)
- ⑤ If the setpoint selection and the internal setpoint for the motor control fall below the brake closing threshold set in 0x2820:007 (P712.07), the output frequency is ramped down to "0 Hz". At the same time the closing threshold delay set in 0x2820:012 (P712.12) starts to run.
- ⑥ If the values fall below the closing threshold longer than the closing threshold delay, the holding brake is closed again.
- ⑦ After the closing time 0x2820:002 (P712.02) has elapsed, the brake status "Active [0]" is displayed in 0x2820:015 (P712.15).
- ⑧ If "Run" is set to FALSE, the motor is stopped with the stop method set in 0x2838:003 (P203.03). In the example: Stop with standard ramp.

### 10.11.5 MANUAL RELEASE OF THE HOLDING BRAKE

A manual release of the holding brake is possible in the modes "Automatic[0]" and "Manual[1]" via the trigger assigned in 0x2631:049 (P400.49) of the "Release holding brake" function.

Parameter	Name / value range / [default setting]	Info
0x2631:049 (P400.49)	Function list: Release holding brake (Function list: Open brake) – Setting can only be changed if the variable speed drive is inhibited. – For further possible settings, see parameter 0x2631:001 (P400.01).	Assignment of a trigger for the "Release holding brake" function Trigger = TRUE: Release holding brake (immediately). Trigger = FALSE: no action. Notes: – Function is only executed if the brake mode 0x2820:001 (P712.01) is set to "Automatic [0]" or "Manual [1]". <b>CAUTION!</b> – The manually triggered "Release holding brake" command has a direct impact on the "Release holding brake [115]" trigger. Thus, the holding brake can be manually released if the power section is switched off! – The responsibility for a manual release of the holding brake has the external trigger source for the "Release holding brake" command!
	<b>0 Not connected</b>	

1585 GB 09 18

### 10.12 FLYING RESTART CIRCUIT

The flying restart function makes it possible to restart a coasting motor on the fly during operation without speed feedback. Synchronicity between the variable speed drive and the motor is coordinated so that the transition to the rotating drive is effected without jerk at the time of connection.

#### Preconditions

- Drive systems with speed feedback do not need a flying restart circuit because there is always a jerk-free synchronisation to the feedback speed.
- The flying restart circuit operates safely and reliably in case of drives with high centrifugal masses. If several motors with different centrifugal masses are connected to the variable speed drive, the flying restart circuit must not be used.
- The flying restart circuit serves to identify rotating field frequencies of up to maximally  $\pm 200$  Hz.

Required settings before the flying restart circuit is used:

1. The motor data must be set correctly. See chapter "Motor data".
2. The settings for the current controller and the flying restart controller must be adapted to the motor. The settings are made automatically if one of the following optimisation is carried out:
  - ▶ Automatic motor identification (energized)
  - ▶ Automatic motor calibration (non-energized)

#### Details

The variable speed drive determines synchronicity by identifying the synchronous rotating field frequency. The "search" starts in positive direction.

#### Duration

- The flying restart process is determined within approx. 0.5 ... 1.5 seconds.
- The duration is influenced by the start frequency 0x2BA1:002 (P718.02).

#### Setting the function:

1. As starting performance, set the selection "Flying restart circuit [2]" in 0x2838:001 (P203.01).
  - Thus, every variable speed drive enable causes a synchronisation to the rotating or standing drive.
  - After the variable speed drive has been enabled, the motor can temporarily start or reverse if drives with low friction and low mass inertia are used.
  - If the variable speed drive is operated with the default settings, no further settings are required for most applications.
2. If required, adapt the current 0x2BA1:001 (P718.01) and the start frequency 0x2BA1:002 (P718.02) for the flying restart circuit.
  - Setting notes can be found in the "Info" column for the respective parameter.

For diagnostic purposes, the frequency detected when the motor has been restarted on the fly is displayed in 0x2BA1:008 (P718.08).

Parameter	Name / value range / [default setting]	Info
0x2BA1:001 (P718.01)	Flying restart circuit: Current (Flying restart: Current) 0 ... [30] ... 100 %	The current set here is injected into the motor during the flying restart process for the identification of the rotating field frequency. – 100 % $\equiv$ Motor rated current 0x6075 (P323.00) – Reducing the current causes a reduction of the motor torque during the flying restart process. – A short-time starting action or reversing of the motor is prevented with low flying restart currents. – If the current is set too low, the rotating field frequency cannot be identified correctly. – If the current is increased, this improves the robustness of the flying restart circuit.
0x2BA1:002 (P718.02)	Flying restart circuit: Start frequency (Flying restart: Start frequency) -599.0 ... [20.0] ... 599.0 Hz	The frequency set here defines the starting point for the flying restart process. – The search starts in positive direction. – The default setting is adjusted to standard asynchronous motors. – In case of systems with a known search speed (e.g. torque-controlled drive systems that are to synchronise to a defined speed), the start frequency can be adapted for reducing the flying restart time.
0x2BA1:008 (P718.08)	Flying restart circuit: Flying restart frequency (Flying restart: Fl.res.frequency) – Read only: x.x Hz	Display of the found frequency at which the motor has been successfully restarted on the fly.

### 10.13 TIMEOUT FAULT REACTION

If an error occurs that does not immediately cause a switch-off, the "Fault reaction active" device status becomes initially active. The motor is brought to a standstill with quick stop ramp. The change to the device status "Fault" is only made after the quick stop (motor at standstill has been executed or after an adjustable timeout time has expired).

#### Details

In the device status "Fault reaction active"

- only the parameters of the variable speed drive can be changed that do not require a variable speed drive disable.
- a holding brake in brake mode 0x2820:001 (P712.01) = "Automatically (via device state)[0]" is triggered for closing.
- the motor control continues to be operable.

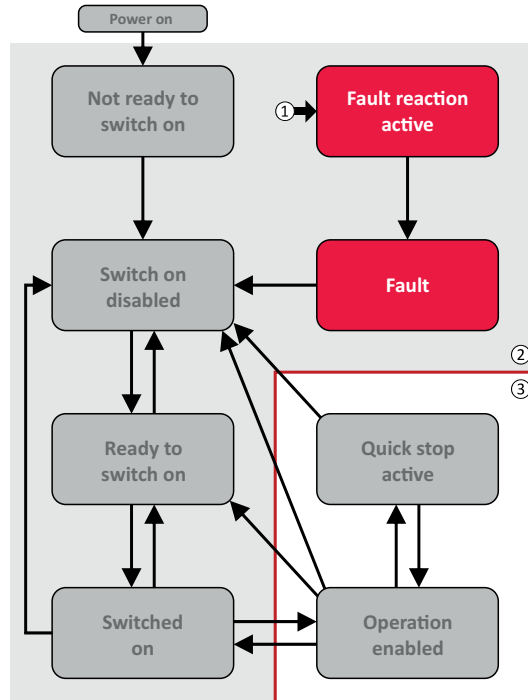

- ① From all states
- ② Power section inhibited (pulse inhibit)
- ③ Power section enabled

#### Diagnostic parameters:

- 0x282A:005 (P126.05) displays the current device status of the variable speed drive.

Parameter	Name / value range / [default setting]	Info
0x2826	Time-out for error response 0.0 ... [6.0] ... 100.0 s	This timer is started when a change-over to the "Fault reaction active" device status takes place. If the motor is still rotating after the time-out time has elapsed, a change-over to the "Fault" device status takes place. – In case of a serious error, an immediate change-over to the "Fault" device status takes place. <b>CAUTION!</b> Changing this parameter may cause a longer ramp time in the event of an error. This must be considered when changing this parameter.

### 10.14 AUTOMATIC RESTART

Configuration of the restart behaviour after a fault.

**i** The settings have no impact on errors and warnings of the variable speed drive.

Parameter	Name / value range / [default setting]	Info
0x2839:002 (P760.02)	Fault configuration: Restart delay (Fault config.: Restart delay) 0.0 ... [3.0] ... 1000.0 s	If a fault occurs, a restart is possible at the earliest after the time set here has elapsed.
0x2839:003 (P760.03)	Fault configuration: Number of restart attempts (Fault config.: Restart counter) 0 ... [5] ... 255	Number of restart attempts after a fault. – 255 = unlimited number of restart attempts.
0x2839:004 (P760.04)	Fault configuration: Trouble counter reset time (Fault config.: Tro.count r.time) 0.1 ... [40.0] ... 3600.0 s	Time of trouble-free operation after the expiry of which the fault counter is decreased by 1.
0x2839:005 (P760.05)	Fault configuration: Trouble counter (Fault config.: Trouble counter) – Read only	Display of the current fault counter content. – The counter content is increased by 1 after each restart attempt.

---

## 10.18 FIRMWARE DOWNLOAD

The device firmware is continuously improved by the manufacturer. New firmware versions contain error corrections, function extensions and simplify the handling.

### 10.18.1 FIRMWARE DOWNLOAD WITH SOFTWARE VLBX SW 02 (FIRMWARE LOADER)

The VLBX SW 02 is a PC software included in the installation package of the software VLBX SW which serves to update the firmware of the variable speed drive.

#### Preconditions

- For the firmware download, we recommend a direct USB connection to the device. For this purpose, the USB module and a USB 2.0 cable (A plug on Micro-B plug) are required. The voltage supply of the control electronics also takes place via the USB connection.
- The control electronics of the variable speed drive must be supplied with voltage via the USB connection.
- Voltage supply and communication must not be interrupted during the firmware download.

## 11 SEQUENCER

The "sequencer" function serves to transfer a programmed sequence of setpoints to the motor control. The switch-over to the next setpoint can be made time-controlled or even-controlled. Optionally the "sequencer" function can also trigger the digital and analog outputs.

**i** The sequencer only generates setpoints. However, the sequencer does not control the motor operation (does not output any start and stop commands).

Basics: Sequences, steps and segments

- As a total, 8 sequences can be configured (with the numbers 1 to 8).
- Each sequence consists of 16 configurable steps.
- Each step of a sequence can call a "segment".
- A segment contains, among other things preset setpoints (speed setpoint, PID control value, torque setpoint), a combined acceleration/deceleration for the speed setpoint and optionally a configuration for the digital and analog outputs.
- 8 different segments and one end segment can be configured.
- Alternatively to calling a single segment, a complete sequence (with a higher number) can also be called from one step. This serves to implement nested sequences or summarise several sequences to one sequence.

1585 GB 09 18

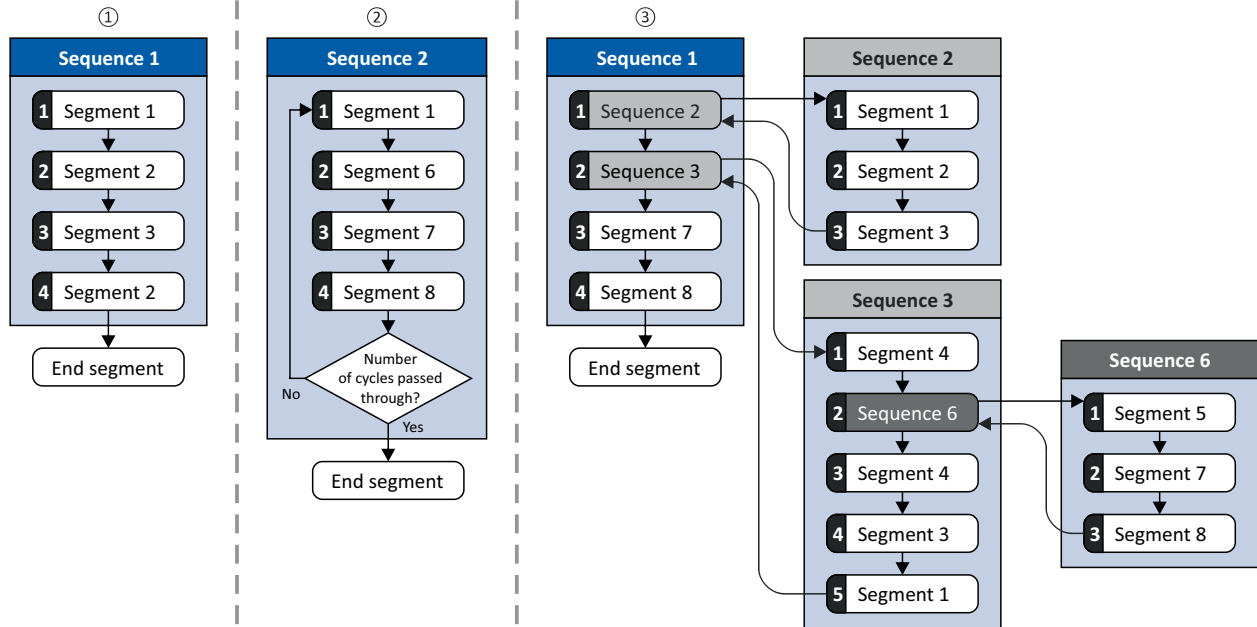

- ① Simple sequence with four steps.
- ② Simple sequence with four steps that are passed through several times (number of cycles > 1).  
For each sequence, the number of cycles can be set individually.
- ③ Nested sequence: Other (sub) sequences are called by one (main) sequence.

### Commissioning

For commissioning the sequencer, we recommend the following proceeding:

1. Configure segments (including end segment).  
Details: ► See chapter "Segment configuration".
2. Configure sequences:
  - a) Assign the segments to the single steps of a sequence.
  - b) Set the number of cycles for the respective sequence.  
Details: ► See chapter "Sequence configuration".
3. Make the basic setting of the sequencer:
  - a) Set the desired operating mode (time and/or step operation)
  - b) Optionally: Adapt end of sequence mode and start of sequence mode.  
Details: ► See chapter "Sequencer basic settings".
4. Configure the control of the sequencer:
  - a) Assign the functions for selecting a sequence to suitable triggers (e. g. digital inputs).
  - b) Assign the functions for controlling the sequencer (start, stop, cancel, ...) to suitable triggers.  
Details: ► See chapter "Sequencer control function".

### Control

The functions listed in the following table serve to control the sequencer. For details, see chapter "Sequencer control function".

Function	Info
Select sequence (bit 0) ... Select sequence (bit 3)	Bit coded selection of the sequence to be started.
Start sequence	The selected sequence is started. The start can take place edge or status-controlled depending on the configuration.
Next sequence step	Immediate jump to the next step irrespective of the time set for the segment.
Pause sequence	The sequencer stops in the current step. The expiration for the time set for the segment is stopped. The sequencer setpoint remains active.
Suspend sequence	There is a temporal return to the normal setpoint control. The sequence is then continued at the point where it was suspended.
Stop sequence	Direct jump to the end segment. The further execution depends on the selected end of sequence mode.
Abort sequence	Immediate return to the normal setpoint control. The end segment is not executed anymore.

## Diagnostics

For diagnosing the sequencer, the diagnostic parameters listed in chapter "Sequencer diagnostic" are available.

## Internal status signals

The sequencer provides different internal status signals (see the following table). These status signals can be assigned to the relay, the digital outputs or the status word.

► See chapter "Configuration of digital outputs".

Internal status signal	Info
"Sequencer controlled [100]"	The control is executed via the sequencer (according to the configuration of the digital outputs for the current segment).
"Sequence active [101]"	The sequence is running and is currently not suspended.
"Sequence suspended [102]"	The sequence is currently suspended.
"Sequence done [103]"	The sequence is completed (end segment was passed through).

1585 GB 09 18

## 11.1 SEGMENT CONFIGURATION

Each step of a sequence can call a "segment". A segment contains, among other things preset setpoints (speed setpoint, PID control value, torque setpoint), a combined acceleration/deceleration for the speed setpoint and optionally a configuration for the digital and analog outputs.

### Details

As a total, 8 segments and one end segment can be configured.

- The settings are only effective if a sequence is active and the respective segment is executed.
- Not all settings are relevant for all operating modes. If, for instance, the PID control is not used at all, no PID setpoint needs to be set for the segment.
- The following figure shows the segment settings relevant for the operating mode 0x6060 (P301.00) = "MS: Velocity mode [-2]".
- The table below contains a short overview of the possible settings for each segment.

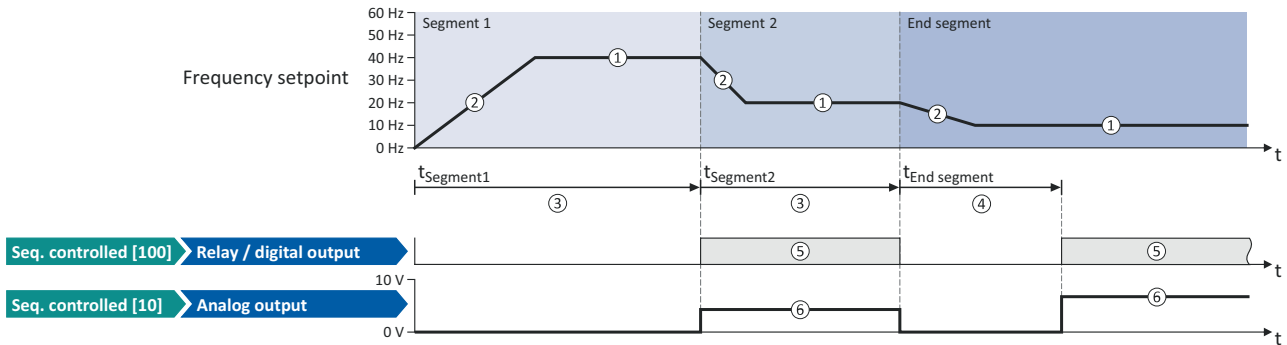

Setting		Info
Frequency setpoint	①	Only relevant for the operating mode 0x6060 (P301.00) = "MS: Velocity mode [-2]". Direction of rotation according to sign.
Acceleration/deceleration	②	Only relevant for operating mode 0x6060 (P301.00) = "MS: Velocity mode [-2]". The set time refers to the acceleration from standstill to the set maximum frequency. The deceleration is effected with the same ramp.
Time	③	Meaning for segment 1 ... 8: Runtime for the segment after the expiry of which it is switched over to the next step of the sequence. Only relevant for Sequencer mode 0x4025 (P800.00) = "Time operation [1]" or "Time & step operation [3]".
	④	Meaning for end segment: Delay time for activation the output states configured for the end segment.
Digital outputs	⑤	Optionally: Set digital outputs to a certain level for the execution time of the segment.
Analog outputs	⑥	Optionally: Set analog outputs to an adjustable voltage value for the execution time of the segment
PID setpoint		Only relevant if the PID control in 0x4020:001 (P600.01) is activated. ► See chapter "Configuring the process controller".
Torque setpoint		Only relevant for operating mode 0x6060 (P301.00) = "MS: Torque mode [-1]". ► See chapter "Torque control w/ freq. limit".

In the following, all parameters relevant for the segment configuration are given.

**i** If the sequencer is active, write access to all parameters are blocked that concern the active segment configuration!



Parameter	Name / value range / [default setting]	Info
0x4026:001 (P801.01)	Sequencer segment 1: Frequency setpoint (Segment 1: Frequency setp.) -599.0 ... [0.0] ... 599.0 Hz	Frequency setpoint for the segment. – Only relevant for operating mode 0x6060 (P301.00) = "MS: Velocity mode [-2]". – Direction of rotation according to sign.
0x4026:002 (P801.02)	Sequencer segment 1: Acceleration/deceleration (Segment 1: Accel./decel.) 0.0 ... [5.0] ... 3600.0 s	Acceleration/deceleration for the segment. – Only relevant for operating mode 0x6060 (P301.00) = "MS: Velocity mode [-2]". – The set time refers to the acceleration from standstill to the set maximum frequency. The deceleration is effected with the same ramp.
0x4026:003	Sequencer segment 1: Time (Segment 1: Time) 0.0 ... [0.0] ... 100000.0 s	Runtime for the segment after the expiry of which it is switched over to the next step of the sequence. – Only relevant for Sequencer mode 0x4025 (P800.00) = "Time operation [1]" or "Time & step operation [3]". – With the setting "0.0", the segment will be skipped.
0x4026:004 (P801.04)	Sequencer segment 1: Digital outputs (Segment 1: Digital outp.) 0 ... [0] ... 255	Optionally: Set digital outputs to the level set here for the execution time of the segment. <b>Note!</b> In order that the control of a digital output is executed by the sequencer, the following assignment must be made for the respective digital output – Relay: 0x2634:001 (P420.01) = "Sequencer controlled [100]" – Digital output 1: 0x2634:002 (P420.02) = "Sequencer controlled [100]"
	Bit 0 Relay	0 = X9/NO-COM open and NC-COM closed. 1 = X9/NO-COM closed and NC-COM open. An inversion set in 0x2635:001 (P421.01) is taken into consideration here.
	Bit 1 Digital output 1	0 = set digital output 1 to LOW level. 1 = set digital output 1 to HIGH level. An inversion set in 0x2635:002 (P421.02) is taken into consideration here.
0x4026:005 (P801.05)	Sequencer segment 1: Analog outputs (Segment 1: Analog outp.) 0.00 ... [0.00] ... 10.00 VDC	Optionally: Set analog output to the voltage value set here for the execution time of the segment. <b>Note!</b> In order that the control of the analog output is executed by the sequencer, the following assignment must be made for the analog output: – Analog output 1: 0x2639:002 (P440.02) = "Sequencer controlled [10]"
0x4026:006 (P801.06)	Sequencer segment 1: PID setpoint (Segment 1: PID setp.) -300.00 ... [0.00] ... 300.00 PID unit	PID control value for the segment. – Only relevant if the PID control in 0x4020:001 (P600.01) is activated.
0x4026:007 (P801.07)	Sequencer segment 1: Torque setpoint (Segment 1: Torque setp.) -400.0 ... [100.0] ... 400.0 %	Torque setpoint for the segment. – Only relevant for operating mode 0x6060 (P301.00) = "MS: Torque mode [-1]".
0x4027:001 (P802.01)	Sequencer segment 2: Frequency setpoint (Segment 2: Frequency setp.) -599.0 ... [0.0] ... 599.0 Hz	Frequency setpoint for the segment. – Only relevant for operating mode 0x6060 (P301.00) = "MS: Velocity mode [-2]". – Direction of rotation according to sign.
0x4027:002	Sequencer segment 2: Acceleration/deceleration (Segment 2: Accel./decel.) 0.0 ... [5.0] ... 3600.0 s	Acceleration/deceleration for the segment. – Only relevant for operating mode 0x6060 (P301.00) = "MS: Velocity mode [-2]". – The set time refers to the acceleration from standstill to the set maximum frequency. The deceleration is effected with the same ramp.
0x4027:003 (P802.03)	Sequencer segment 2: Time (Segment 2: Time) 0.0 ... [0.0] ... 100000.0 s	Runtime for the segment after the expiry of which it is switched over to the next step of the sequence. – Only relevant for Sequencer mode 0x4025 (P800.00) = "Time operation [1]" or "Time & step operation [3]". – With the setting "0.0", the segment will be skipped.
0x4027:004 (P802.04)	Sequencer segment 2: Digital outputs (Segment 2: Digital outp.) 0 ... [0] ... 255	Optionally: Set digital outputs to the level set here for the execution time of the segment. <b>Note!</b> In order that the control of a digital output is executed by the sequencer, the following assignment must be made for the respective digital output: – Relay: 0x2634:001 (P420.01) = "Sequencer controlled [100]" – Digital output 1: 0x2634:002 (P420.02) = "Sequencer controlled [100]"
	Bit 0 Relay	0 = X9/NO-COM open and NC-COM closed. 1 = X9/NO-COM closed and NC-COM open. An inversion set in 0x2635:001 (P421.01) is taken into consideration here.
	Bit 1 Digital output 1	0 = set digital output 1 to LOW level. 1 = set digital output 1 to HIGH level. An inversion set in 0x2635:002 (P421.02) is taken into consideration here.
0x4027:005 (P802.05)	Sequencer segment 2: Analog outputs (Segment 2: Analog outp.) 0.00 ... [0.00] ... 10.00 VDC	Optionally: Set analog output to the voltage value set here for the execution time of the segment. <b>Note!</b> In order that the control of the analog output is executed by the sequencer, the following assignment must be made for the analog output: – Analog output 1: 0x2639:002 (P440.02) = "Sequencer controlled [10]"
0x4027:006 (P802.06)	Sequencer segment 2: PID setpoint (Segment 2: PID setp.) -300.00 ... [0.00] ... 300.00 PID unit	PID control value for the segment. – Only relevant if the PID control in 0x4020:001 (P600.01) is activated.
0x4027:007 (P802.07)	Sequencer segment 2: Torque setpoint (Segment 2: Torque setp.) -400.0 ... [100.0] ... 400.0 %	Torque setpoint for the segment. – Only relevant for operating mode 0x6060 (P301.00) = "MS: Torque mode [-1]".
0x4028:001 (P803.01)	Sequencer segment 3: Frequency setpoint (Segment 3: Frequency setp.) -599.0 ... [0.0] ... 599.0 Hz	Frequency setpoint for the segment. – Only relevant for operating mode 0x6060 (P301.00) = "MS: Velocity mode [-2]". – Direction of rotation according to sign.
0x4028:002 (P803.02)	Sequencer segment 3: Acceleration/deceleration (Segment 3: Accel./decel.) 0.0 ... [5.0] ... 3600.0 s	Acceleration/deceleration for the segment. – Only relevant for operating mode 0x6060 (P301.00) = "MS: Velocity mode [-2]". – The set time refers to the acceleration from standstill to the set maximum frequency. The deceleration is effected with the same ram
0x4028:003 (P803.03)	Sequencer segment 3: Time (Segment 3: Time) 0.0 ... [0.0] ... 100000.0 s	Runtime for the segment after the expiry of which it is switched over to the next step of the sequence. – Only relevant for Sequencer mode 0x4025 (P800.00) = "Time operation [1]" or "Time & step operation [3]". – With the setting "0.0", the segment will be skipped.

Parameter	Name / value range / [default setting]	Info
0x4028:004 (P803.04)	Sequencer segment 3: Digital outputs (Segment 3: Digital outp.) 0 ... [0] ... 255	Optionally: Set digital outputs to the level set here for the execution time of the segment. Note! In order that the control of a digital output is executed by the sequencer, the following assignment must be made for the respective digital output: – Relay: 0x2634:001 (P420.01) = "Sequencer controlled [100]" – Digital output 1: 0x2634:002 (P420.02) = "Sequencer controlled [100]"
	Bit 0 Relay	0 = X9/NO-COM open and NC-COM closed. 1 = X9/NO-COM closed and NC-COM open. An inversion set in 0x2635:001 (P421.01) is taken into consideration here.
	Bit 1 Digital output 1	0 = set digital output 1 to LOW level. 1 = set digital output 1 to HIGH level. An inversion set in 0x2635:002 (P421.02) is taken into consideration here.
0x4028:005 (P803.05)	Sequencer segment 3: Analog outputs (Segment 3: Analog outp.) 0.00 ... [0.00] ... 10.00 VDC	Optionally: Set analog output to the voltage value set here for the execution time of the segment. Note! In order that the control of the analog output is executed by the sequencer, the following assignment must be made for the analog output: – Analog output 1: 0x2639:002 (P440.02) = "Sequencer controlled [10]"
0x4028:006 (P803.06)	Sequencer segment 3: PID setpoint (Segment 3: PID setp.) -300.00 ... [0.00] ... 300.00 PID unit	PID control value for the segment. – Only relevant if the PID control in 0x4020:001 (P600.01) is activated.
0x4028:007 (P803.07)	Sequencer segment 3: Torque setpoint (Segment 3: Torque setp.) -400.0 ... [100.0] ... 400.0 %	Torque setpoint for the segment. – Only relevant for operating mode 0x6060 (P301.00) = "MS: Torque mode [-1]".
0x4029:001 (P804.01)	Sequencer segment 4: Frequency setpoint (Segment 4: Frequency setp.) -599.0 ... [0.0] ... 599.0 Hz	Frequency setpoint for the segment. – Only relevant for operating mode 0x6060 (P301.00) = "MS: Velocity mode [-2]". – Direction of rotation according to sign.
0x4029:002 (P804.02)	Sequencer segment 4: Acceleration/deceleration (Segment 4: Accel./decel.) 0.0 ... [5.0] ... 3600.0 s	Acceleration/deceleration for the segment. – Only relevant for operating mode 0x6060 (P301.00) = "MS: Velocity mode [-2]". – The set time refers to the acceleration from standstill to the set maximum frequency. The deceleration is effected with the same ramp.
0x4029:003 (P804.03)	Sequencer segment 4: Time (Segment 4: Time) 0.0 ... [0.0] ... 100000.0 s	Runtime for the segment after the expiry of which it is switched over to the next step of the sequence. – Only relevant for Sequencer mode 0x4025 (P800.00) = "Time operation [1]" or "Time & step operation [3]". – With the setting "0.0", the segment will be skipped.
0x4029:004 (P804.04)	Sequencer segment 4: Digital outputs (Segment 4: Digital outp.) 0 ... [0] ... 255	Optionally: Set digital outputs to the level set here for the execution time of the segment. Note! In order that the control of a digital output is executed by the sequencer, the following assignment must be made for the respective digital output: – Relay: 0x2634:001 (P420.01) = "Sequencer controlled [100]" – Digital output 1: 0x2634:002 (P420.02) = "Sequencer controlled [100]"
	Bit 0 Relay	0 = X9/NO-COM open and NC-COM closed. 1 = X9/NO-COM closed and NC-COM open. An inversion set in 0x2635:001 (P421.01) is taken into consideration here.
	Bit 1 Digital output 1	0 = set digital output 1 to LOW level. 1 = set digital output 1 to HIGH level. An inversion set in 0x2635:002 (P421.02) is taken into consideration here.
0x4029:005 (P804.05)	Sequencer segment 4: Analog outputs (Segment 4: Analog outp.) 0.00 ... [0.00] ... 10.00 VDC	Optionally: Set analog output to the voltage value set here for the execution time of the segment. Note! In order that the control of the analog output is executed by the sequencer, the following assignment must be made for the analog output: – Analog output 1: 0x2639:002 (P440.02) = "Sequencer controlled [10]"
0x4029:006 (P804.06)	Sequencer segment 4: PID setpoint (Segment 4: PID setp.) -300.00 ... [0.00] ... 300.00 PID unit	PID control value for the segment. – Only relevant if the PID control in 0x4020:001 (P600.01) is activated.
0x4029:007 (P804.07)	Sequencer segment 4: Torque setpoint (Segment 4: Torque setp.) -400.0 ... [100.0] ... 400.0 %	Torque setpoint for the segment. – Only relevant for operating mode 0x6060 (P301.00) = "MS: Torque mode [-1]".
0x402A:001 (P805.01)	Sequencer segment 5: Frequency setpoint (Segment 5: Frequency setp.) -599.0 ... [0.0] ... 599.0 Hz	Frequency setpoint for the segment. – Only relevant for operating mode 0x6060 (P301.00) = "MS: Velocity mode [-2]". – Direction of rotation according to sign.
0x402A:002 (P805.02)	Sequencer segment 5: Acceleration/deceleration (Segment 5: Accel./decel.) 0.0 ... [5.0] ... 3600.0 s	Acceleration/deceleration for the segment. – Only relevant for operating mode 0x6060 (P301.00) = "MS: Velocity mode [-2]". – The set time refers to the acceleration from standstill to the set maximum frequency. The deceleration is effected with the same ramp.
0x402A:003 (P805.03)	Sequencer segment 5: Time (Segment 5: Time) 0.0 ... [0.0] ... 100000.0 s	Runtime for the segment after the expiry of which it is switched over to the next step of the sequence. – Only relevant for Sequencer mode 0x4025 (P800.00) = "Time operation [1]" or "Time & step operation [3]". – With the setting "0.0", the segment will be skipped.

Parameter	Name / value range / [default setting]	Info
0x402A:004 (P805.04)	Sequencer segment 5: Digital outputs (Segment 5: Digital outp.) 0 ... [0] ... 255	Optionally: Set digital outputs to the level set here for the execution time of the segment. Note! In order that the control of a digital output is executed by the sequencer, the following assignment must be made for the respective digital output: – Relay: 0x2634:001 (P420.01) = "Sequencer controlled [100]" – Digital output 1: 0x2634:002 (P420.02) = "Sequencer controlled [100]"
	Bit 0 Relay	0 = X9/NO-COM open and NC-COM closed. 1 = X9/NO-COM closed and NC-COM open. An inversion set in 0x2635:001 (P421.01) is taken into consideration here.
	Bit 1 Digital output 1	0 = set digital output 1 to LOW level. 1 = set digital output 1 to HIGH level. An inversion set in 0x2635:002 (P421.02) is taken into consideration here.
0x402A:005 (P805.05)	Sequencer segment 5: Analog outputs (Segment 5: Analog outp.) 0.00 ... [0.00] ... 10.00 VDC	Optionally: Set analog output to the voltage value set here for the execution time of the segment. Note! In order that the control of the analog output is executed by the sequencer, the following assignment must be made for the analog output: – Analog output 1: 0x2639:002 (P440.02) = "Sequencer controlled [10]"
0x402A:006 (P805.06)	Sequencer segment 5: PID setpoint (Segment 5: PID setp.) -300.00 ... [0.00] ... 300.00 PID unit	PID control value for the segment. – Only relevant if the PID control in 0x4020:001 (P600.01) is activated.
0x402A:007 (P805.07)	Sequencer segment 5: Torque setpoint (Segment 5: Torque setp.) -400.0 ... [100.0] ... 400.0 %	Torque setpoint for the segment. – Only relevant for operating mode 0x6060 (P301.00) = "MS: Torque mode [-1]".
0x402B:001 (P806.01)	Sequencer segment 6: Frequency setpoint (Segment 6: Frequency setp.) -599.0 ... [0.0] ... 599.0 Hz	Frequency setpoint for the segment. – Only relevant for operating mode 0x6060 (P301.00) = "MS: Velocity mode [-2]". – Direction of rotation according to sign.
0x402B:002 (P806.02)	Sequencer segment 6: Acceleration/deceleration (Segment 6: Accel./decel.) 0.0 ... [5.0] ... 3600.0 s	Acceleration/deceleration for the segment. – Only relevant for operating mode 0x6060 (P301.00) = "MS: Velocity mode [-2]". – The set time refers to the acceleration from standstill to the set maximum frequency. The deceleration is effected with the same ramp.
0x402B:003 (P806.03)	Sequencer segment 6: Time (Segment 6: Time) 0.0 ... [0.0] ... 100000.0 s	Runtime for the segment after the expiry of which it is switched over to the next step of the sequence. – Only relevant for Sequencer mode 0x4025 (P800.00) = "Time operation [1]" or "Time & step operation [3]". – With the setting "0.0", the segment will be skipped.
0x402B:004 (P806.04)	Sequencer segment 6: Digital outputs (Segment 6: Digital outp.) 0 ... [0] ... 255	Optionally: Set digital outputs to the level set here for the execution time of the segment. Note! In order that the control of a digital output is executed by the sequencer, the following assignment must be made for the respective digital output: – Relay: 0x2634:001 (P420.01) = "Sequencer controlled [100]" – Digital output 1: 0x2634:002 (P420.02) = "Sequencer controlled [100]"
	Bit 0 Relay	0 = X9/NO-COM open and NC-COM closed. 1 = X9/NO-COM closed and NC-COM open. An inversion set in 0x2635:001 (P421.01) is taken into consideration here.
	Bit 1 Digital output 1	0 = set digital output 1 to LOW level. 1 = set digital output 1 to HIGH level. An inversion set in 0x2635:002 (P421.02) is taken into consideration here.
0x402B:005 (P806.05)	Sequencer segment 6: Analog outputs (Segment 6: Analog outp.) 0.00 ... [0.00] ... 10.00 VDC	Optionally: Set analog output to the voltage value set here for the execution time of the segment. Note! In order that the control of the analog output is executed by the sequencer, the following assignment must be made for the analog output: – Analog output 1: 0x2639:002 (P440.02) = "Sequencer controlled [10]"
0x402B:006 (P806.06)	Sequencer segment 6: PID setpoint (Segment 6: PID setp.) -300.00 ... [0.00] ... 300.00 PID unit	PID control value for the segment. – Only relevant if the PID control in 0x4020:001 (P600.01) is activated.
0x402B:007 (P806.07)	Sequencer segment 6: Torque setpoint (Segment 6: Torque setp.) -400.0 ... [100.0] ... 400.0 %	Torque setpoint for the segment. – Only relevant for operating mode 0x6060 (P301.00) = "MS: Torque mode [-1]".
0x402C:001 (P807.01)	Sequencer segment 7: Frequency setpoint (Segment 7: Frequency setp.) -599.0 ... [0.0] ... 599.0 Hz	Frequency setpoint for the segment. – Only relevant for operating mode 0x6060 (P301.00) = "MS: Velocity mode [-2]". – Direction of rotation according to sign.
0x402C:002 (P807.02)	Sequencer segment 7: Acceleration/deceleration (Segment 7: Accel./decel.) 0.0 ... [5.0] ... 3600.0 s	Acceleration/deceleration for the segment. – Only relevant for operating mode 0x6060 (P301.00) = "MS: Velocity mode [-2]". – The set time refers to the acceleration from standstill to the set maximum frequency. The deceleration is effected with the same ramp
0x402C:003 (P807.03)	Sequencer segment 7: Time (Segment 7: Time) 0.0 ... [0.0] ... 100000.0 s	Runtime for the segment after the expiry of which it is switched over to the next step of the sequence. – Only relevant for Sequencer mode 0x4025 (P800.00) = "Time operation [1]" or "Time & step operation [3]". – With the setting "0.0", the segment will be skipped.

Parameter	Name / value range / [default setting]	Info
0x402C:004 (P807.04)	Sequencer segment 7: Digital outputs (Segment 7: Digital outp.) 0 ... [0] ... 255	Optionally: Set digital outputs to the level set here for the execution time of the segment. Note! In order that the control of a digital output is executed by the sequencer, the following assignment must be made for the respective digital output: – Relay: 0x2634:001 (P420.01) = "Sequencer controlled [100]" – Digital output 1: 0x2634:002 (P420.02) = "Sequencer controlled [100]"
	Bit 0 Relay	0 = X9/NO-COM open and NC-COM closed. 1 = X9/NO-COM closed and NC-COM open. An inversion set in 0x2635:001 (P421.01) is taken into consideration here.
	Bit 1 Digital output 1	0 = set digital output 1 to LOW level. 1 = set digital output 1 to HIGH level. An inversion set in 0x2635:002 (P421.02) is taken into consideration here.
0x402C:005 (P807.05)	Sequencer segment 7: Analog outputs (Segment 7: Analog outp.) 0.00 ... [0.00] ... 10.00 VDC	Optionally: Set analog output to the voltage value set here for the execution time of the segment. Note! In order that the control of the analog output is executed by the sequencer, the following assignment must be made for the analog output: – Analog output 1: 0x2639:002 (P440.02) = "Sequencer controlled [10]"
0x402C:006 (P807.06)	Sequencer segment 7: PID setpoint (Segment 7: PID setp.) -300.00 ... [0.00] ... 300.00 PID unit	PID control value for the segment. – Only relevant if the PID control in 0x4020:001 (P600.01) is activated.
0x402C:007 (P807.07)	Sequencer segment 7: Torque setpoint (Segment 7: Torque setp.) -400.0 ... [100.0] ... 400.0 %	Torque setpoint for the segment. – Only relevant for operating mode 0x6060 (P301.00) = "MS: Torque mode [-1]".
0x402D:001 (P808.01)	Sequencer segment 8: Frequency setpoint (Segment 8: Frequency setp.) -599.0 ... [0.0] ... 599.0 Hz	Frequency setpoint for the segment. – Only relevant for operating mode 0x6060 (P301.00) = "MS: Velocity mode [-2]". – Direction of rotation according to sign.
0x402D:002 (P808.02)	Sequencer segment 8: Acceleration/deceleration (Segment 8: Accel./decel.) 0.0 ... [5.0] ... 3600.0 s	Acceleration/deceleration for the segment. – Only relevant for operating mode 0x6060 (P301.00) = "MS: Velocity mode [-2]". – The set time refers to the acceleration from standstill to the set maximum frequency. The deceleration is effected with the same ramp.
0x402D:003 (P808.03)	Sequencer segment 8: Time (Segment 8: Time) 0.0 ... [0.0] ... 100000.0 s	Runtime for the segment after the expiry of which it is switched over to the next step of the sequence. – Only relevant for Sequencer mode 0x4025 (P800.00) = "Time operation [1]" or "Time & step operation [3]". – With the setting "0.0", the segment will be skipped.
0x402D:004 (P808.04)	Sequencer segment 8: Digital outputs (Segment 8: Digital outp.) 0 ... [0] ... 255	Optionally: Set digital outputs to the level set here for the execution time of the segment. Note! In order that the control of a digital output is executed by the sequencer, the following assignment must be made for the respective digital output: – Relay: 0x2634:001 (P420.01) = "Sequencer controlled [100]" – Digital output 1: 0x2634:002 (P420.02) = "Sequencer controlled [100]"
	Bit 0 Relay	0 = X9/NO-COM open and NC-COM closed. 1 = X9/NO-COM closed and NC-COM open. An inversion set in 0x2635:001 (P421.01) is taken into consideration here.
	Bit 1 Digital output 1	0 = set digital output 1 to LOW level. 1 = set digital output 1 to HIGH level. An inversion set in 0x2635:002 (P421.02) is taken into consideration here.
0x402D:005 (P808.05)	Sequencer segment 8: Analog outputs (Segment 8: Analog outp.) 0.00 ... [0.00] ... 10.00 VDC	Optionally: Set analog output to the voltage value set here for the execution time of the segment. Note! In order that the control of the analog output is executed by the sequencer, the following assignment must be made for the analog output: – Analog output 1: 0x2639:002 (P440.02) = "Sequencer controlled [10]"
0x402D:006 (P808.06)	Sequencer segment 8: PID setpoint (Segment 8: PID setp.) -300.00 ... [0.00] ... 300.00 PID unit	PID control value for the segment. – Only relevant if the PID control in 0x4020:001 (P600.01) is activated.
0x402D:007 (P808.07)	Sequencer segment 8: Torque setpoint (Segment 8: Torque setp.) -400.0 ... [100.0] ... 400.0 %	Torque setpoint for the segment. – Only relevant for operating mode 0x6060 (P301.00) = "MS: Torque mode [-1]".
0x402E:001 (P822.01)	End segment: Frequency setpoint (End segment: Frequency setp.) -599.0 ... [0.0] ... 599.0 Hz	Frequency setpoint after the sequence has been completed, i. e., after the steps configured for the sequence have been passed through with the set numbers of cycles. – Only relevant for the operating mode 0x6060 (P301.00) = "MS: Velocity mode [-2]" and if end of sequence mode 0x402F (P824.00) = "Keep running [0]". – Direction of rotation according to sign.
0x402E:002 (P822.02)	End segment: Acceleration/deceleration (End segment: Accel./decel.) 0.0 ... [5.0] ... 3600.0 s	If end of sequence mode = "continuous operation" (default setting): Acceleration/deceleration for reaching the frequency setpoint set for the end segment after the sequence has been processed. If end of sequence mode = "Stop" or "Stop and abort": Deceleration for reaching standstill after the sequence has been processed. – Only relevant for operating mode 0x6060 (P301.00) = "MS: Velocity mode [-2]". – The set time refers to the acceleration from standstill to the set maximum frequency. The deceleration is effected with the same ramp.

Parameter	Name / value range / [default setting]	Info
0x402E:003 (P822.03)	End segment: Time (End segment: Time) 0.0 ... [0.0] ... 100000.0 s	Delay time for activating the output states configured for the end segment. – This parameter has a different meaning than the time setting for the segments 1 ... 8! – The set deceleration time starts when the end segment is started to be processed. After the deceleration time has elapsed: – The digital output is set to the level set in 0x402E:004 (P822.04) (if configured accordingly). – The analog output is set to the voltage value set in 0x402E:005 (P822.05) (if configured accordingly).
0x402E:004 (P822.04)	End segment: Digital outputs (End segment: Digital outp.) 0 ... [0] ... 255	Optionally: Set digital outputs to the levels set here after the time set for the end segment.
	Bit 0 Relay	0 = X9/NO-COM open and NC-COM closed. 1 = X9/NO-COM closed and NC-COM open. An inversion set in 0x2635:001 (P421.01) is taken into consideration here.
	Bit 1 Digital output 1	0 = set digital output 1 to LOW level. 1 = set digital output 1 to HIGH level. An inversion set in 0x2635:002 (P421.02) is taken into consideration here.
0x402E:005 ) (P822.05)	End segment: Analog outputs (End segment: Analog outp.) 0.00 ... [0.00] ... 10.00 VDC	Optionally: Set analog output to the voltage value set here after the time set for the end segment. Note! In order that the control of the analog output is executed by the sequencer, the following assignment must be made for the analog output: – Analog output 1: 0x2639:002 (P440.02) = "Sequencer controlled [10]"
0x402E:006 (P822.06)	End segment: PID setpoint (End segment: PID setp.) -300.00 ... [0.00] ... 300.00 PID unit	PID control value after the sequence has been completed, i. e., after the steps configured for the sequence have been passed through with the set numbers of cycles. – Only relevant if PID control is activated in 0x4020:001 (P600.01) and end of sequence mode 0x402F (P824.00) = "Keep running [0]".
0x402E:007 (P822.07)	End segment: Torque setpoint (End segment: Torque setp.) -400.0 ... [100.0] ... 400.0 %	Torque setpoint after the sequence has been completed, i. e., after the steps configured for the sequence have been passed through with the set numbers of cycles. – Only relevant for the operating mode 0x6060 (P301.00) = "MS: Torqu mode [-1]" and if end of sequence mode 0x402F (P824.00) = "Keep running [0]".

## 11.2 SEQUENCE CONFIGURATION

As a total, 8 sequences can be configured (with the numbers 1 to 8). Each sequence consists of 16 configurable steps. Each step of a sequence can call a segment or a complete sequence (with a higher number).

### Details

The following example illustrates the configuration based on a nested sequence:

- The sequence 1 is the main sequence which calls further (sub) sequences.
- The main sequence is passed through four times. Afterwards in the preset "continuous operation" end of sequence mode, the setpoint set for the end segment is continuously transmitted to the motor control until the sequence is aborted.

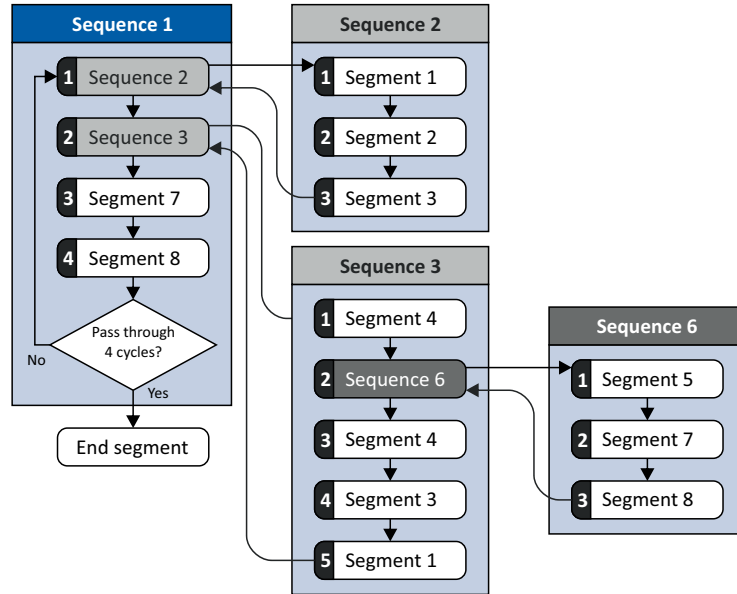

Resulting segment order												
1	2	3	4	5	7	8	4	3	1	7	8	End segment
4 cycles												

### Required parameter setting:

	Sequence 1	Sequence 2
Step 1	0x4030:001 (P830.01) = "Sequence 2 [-2]"	0x4032:001 (P835.01) = "Segment 1 [1]"
Step 2	0x4030:002 (P830.02) = "Sequence 3 [-3]"	0x4032:002 (P835.02) = "Segment 2 [2]"
Step 3	0x4030:003 (P830.03) = "Segment 7 [7]"	0x4032:003 (P835.03) = "Segment 3 [3]"
Step 4	0x4030:004 (P830.04) = "Segment 8 [8]"	0x4032:004 (P835.04) = "Skip step [0]"
Step 5	0x4030:005 (P830.05) = "Skip step [0]"	...
Step ...	...	...
Step 16	0x4030:016 (P830.16) = "Skip step [0]"	0x4032:016 (P835.16) = "Skip step [0]"
Number of cycles	0x4031 (P831.00) = 4	0x4033 (P836.00) = 1

	Sequence 3	Sequence 6
Step 1	0x4034:001 (P840.01) = "Segment 4 [4]"	0x403A:001 (P855.01) = "Segment 5 [5]"
Step 2	0x4034:002 (P840.02) = "Sequence 6 [-6]"	0x403A:002 (P855.02) = "Segment 7 [7]"
Step 3	0x4034:003 (P840.03) = "Segment 4 [4]"	0x403A:003 (P855.03) = "Segment 8 [8]"
Step 4	0x4034:004 (P840.04) = "Segment 3 [3]"	0x403A:004 (P855.04) = "Skip step [0]"
Step 5	0x4034:005 (P840.05) = "Segment 1 [1]"	...
Step 6	0x4034:006 (P840.06) = "Skip step [0]"	...
Step ...	...	...
Step 16	0x4034:016 (P840.16) = "Skip step [0]"	0x403A:016 (P855.16) = "Skip step [0]"
Number of cycles	0x4035 (P841.00) = 1	0x403B (P856.00) = 1

In the following, all parameters relevant for the sequence configuration are given.

**I** If the sequencer is active, write accessed to all parameters are blocked that concern the active sequence configuration!

1585 GB 09 18

Parameter	Name / value range / [default setting]	Info
0x4030:001 ... 0x4030:016 (P830.01 ... 16)	Sequence 1: Step 1 ... Step 16 (Sequence 1: Step 1 ... Step 16)	Configuration of the steps 1 ... 16 for sequence 1. – Alternatively to calling a single segment, a complete sequence (with a higher number) can also be called from one step. This, for instance, serves to configure a main sequence from which several subsequences are called successively. – With the setting "0", the respective step is skipped.
	-8 Sequence 8	
	-7 Sequence 7	
	-6 Sequence 6	
	-5 Sequence 5	
	-4 Sequence 4	
	-3 Sequence 3	
	-2 Sequence 2	
	<b>0 Skip step</b>	
	1 Segment 1	
	2 Segment 2	
	3 Segment 3	
	4 Segment 4	
	5 Segment 5	
	6 Segment 6	
7 Segment 7		
8 Segment 8		
0x4031 (P831.00)	Number of cycles sequence 1 (Cycl. sequence 1) 1 ... [1] ... 65535	Definition of how often the sequence 1 is to be passed through. – 1 = one pass, 2 = two passes, ... – 65535 = infinite number of cycles.
0x4032:001 ... 0x4032:016 (P835.01 ... 16)	Sequence 2: Step 1 ... Step 16 (Sequence 2: Step 1 ... Step 16)	Configuration of the steps 1 ... 16 for sequence 2. – Alternatively to calling a single segment, a complete sequence (with a higher number) can also be called from one step. This, for instance, serves to configure a main sequence from which several subsequences are called successively. – With the setting "0", the respective step is skipped.
	-8 Sequence 8	
	-7 Sequence 7	
	-6 Sequence 6	
	-5 Sequence 5	
	-4 Sequence 4	
	-3 Sequence 3	
	<b>0 Skip step</b>	
	1 Segment 1	
	2 Segment 2	
	3 Segment 3	
	4 Segment 4	
	5 Segment 5	
	6 Segment 6	
	7 Segment 7	
8 Segment 8		
0x4033 (P836.00)	Number of cycles sequence 2 (Cycl. sequence 2) 1 ... [1] ... 65535	Definition of how often the sequence 2 is to be passed through. – 1 = one pass, 2 = two passes, ... – 65535 = infinite number of cycles.
0x4034:001 ... 0x4034:016 (P840.01 ... 16)	Sequence 3: Step 1 ... Step 16 (Sequence 3: Step 1 ... Step 16)	Configuration of the steps 1 ... 16 for sequence 3. – Alternatively to calling a single segment, a complete sequence (with a higher number) can also be called from one step. This, for instance, serves to configure a main sequence from which several subsequences are called successively. – With the setting "0", the respective step is skipped.
	-8 Sequence 8	
	-7 Sequence 7	
	-6 Sequence 6	
	-5 Sequence 5	
	-4 Sequence 4	
	<b>0 Skip step</b>	
	1 Segment 1	
	2 Segment 2	
	3 Segment 3	
	4 Segment 4	
	5 Segment 5	
	6 Segment 6	
	7 Segment 7	
	8 Segment 8	
0x4035 (P841.00)	Number of cycles sequence 3 (Cycl. sequence 3) 1 ... [1] ... 65535	Definition of how often the sequence 3 is to be passed through. – 1 = one pass, 2 = two passes, ... – 65535 = infinite number of cycles.

Parameter	Name / value range / [default setting]	Info
0x4036:001 ... 0x4036:016 (P845.01 ... 16)	Sequence 4: Step 1 ... Step 16 (Sequence 4: Step 1 ... Step 16)	Configuration of the steps 1 ... 16 for sequence 4. – Alternatively to calling a single segment, a complete sequence (with a higher number) can also be called from one step. This, for instance, serves to configure a main sequence from which several subsequences are called successively. – With the setting "0", the respective step is skipped.
	-8   Sequence 8	
	-7   Sequence 7	
	-6   Sequence 6	
	-5   Sequence 5	
	<b>0</b>   <b>Skip step</b>	
	1   Segment 1	
	2   Segment 2	
	3   Segment 3	
	4   Segment 4	
	5   Segment 5	
	6   Segment 6	
7   Segment 7		
8   Segment 8		
0x4037 (P846.00)	Number of cycles sequence 4 (Cycl. sequence 4) 1 ... [1] ... 65535	Definition of how often the sequence 4 is to be passed through. – 1 = one pass, 2 = two passes, ... – 65535 = infinite number of cycles.
0x4038:001 ... 0x4038:016 (P850.01 ... 16)	Sequence 5: Step 1 ... Step 16 (Sequence 5: Step 1 ... Step 16)	Configuration of the steps 1 ... 16 for sequence 5. – Alternatively to calling a single segment, a complete sequence (with a higher number) can also be called from one step. This, for instance, serves to configure a main sequence from which several subsequences are called successively. – With the setting "0", the respective step is skipped.
	-8   Sequence 8	
	-7   Sequence 7	
	-6   Sequence 6	
	<b>0</b>   <b>Skip step</b>	
	1   Segment 1	
	2   Segment 2	
	3   Segment 3	
	4   Segment 4	
	5   Segment 5	
	6   Segment 6	
	7   Segment 7	
8   Segment 8		
0x4039 (P851.00)	Number of cycles sequence 5 (Cycl. sequence 5) 1 ... [1] ... 65535	Definition of how often the sequence 5 is to be passed through. – 1 = one pass, 2 = two passes, ... – 65535 = infinite number of cycles.
0x403A:001 ... 0x403A:016 (P855.01 ... 16)	Sequence 6: Step 1 ... Step 16 (Sequence 6: Step 1 ... Step 16)	Configuration of the steps 1 ... 16 for sequence 6. – Alternatively to calling a single segment, a complete sequence (with a higher number) can also be called from one step. This, for instance, serves to configure a main sequence from which several subsequences are called successively. – With the setting "0", the respective step is skipped.
	-8   Sequence 8	
	-7   Sequence 7	
	<b>0</b>   <b>Skip step</b>	
	1   Segment 1	
	2   Segment 2	
	3   Segment 3	
	4   Segment 4	
	5   Segment 5	
	6   Segment 6	
	7   Segment 7	
	8   Segment 8	
0x403B (P856.00)	Number of cycles sequence 6 (Cycl. sequence 6) 1 ... [1] ... 65535	Definition of how often the sequence 6 is to be passed through. – 1 = one pass, 2 = two passes, ... – 65535 = infinite number of cycles.
0x403C:001 ... 0x403C:016 (P860.01 ... 16)	Sequence 7: Step 1 ... Step 16 (Sequence 7: Step 1 ... Step 16)	Configuration of the steps 1 ... 16 for sequence 7. – Alternatively to calling a single segment, a complete sequence (with a higher number) can also be called from one step. This, for instance, serves to configure a main sequence from which several subsequences are called successively. – With the setting "0", the respective step is skipped.
	-8   Sequence 8	
	<b>0</b>   <b>Skip step</b>	
	1   Segment 1	
	2   Segment 2	
	3   Segment 3	
	4   Segment 4	
	5   Segment 5	
	6   Segment 6	
	7   Segment 7	
	8   Segment 8	
	0x403D (P861.00)	



Parameter	Name / value range / [default setting]	Info
0x403E:001 ... 0x403E:016 (P865.01 ... 16)	Sequence 8: Step 1 ... Step 16 (Sequence 8: Step 1 ... Step 16)	Configuration of the steps 1 ... 16 for sequence 8. – With the setting "0", the respective step is skipped.
	0 Skip step	
	1 Segment 1	
	2 Segment 2	
	3 Segment 3	
	4 Segment 4	
	5 Segment 5	
	6 Segment 6	
	7 Segment 7	
	8 Segment 8	
0x403F (P866.00)	Number of cycles sequence 8 (Cycl. sequence 8) 1 ... [1] ... 65535	Definition of how often the sequence 8 is to be passed through. – 65535 = infinite number of cycles.

### 11.3 SEQUENCER BASIC SETTINGS

In the presetting, the sequencer is disabled. In order to enable the sequencer, the desired sequencer mode (time and/or step operation) must be set. Moreover, different end of sequence modes and start of sequences modes are available.

#### Details

Sequencer mode 0x4025 (P800.00)

- The sequencer can be operated in time and/or step operation.
- The following diagram demonstrates the different sequencer modes:

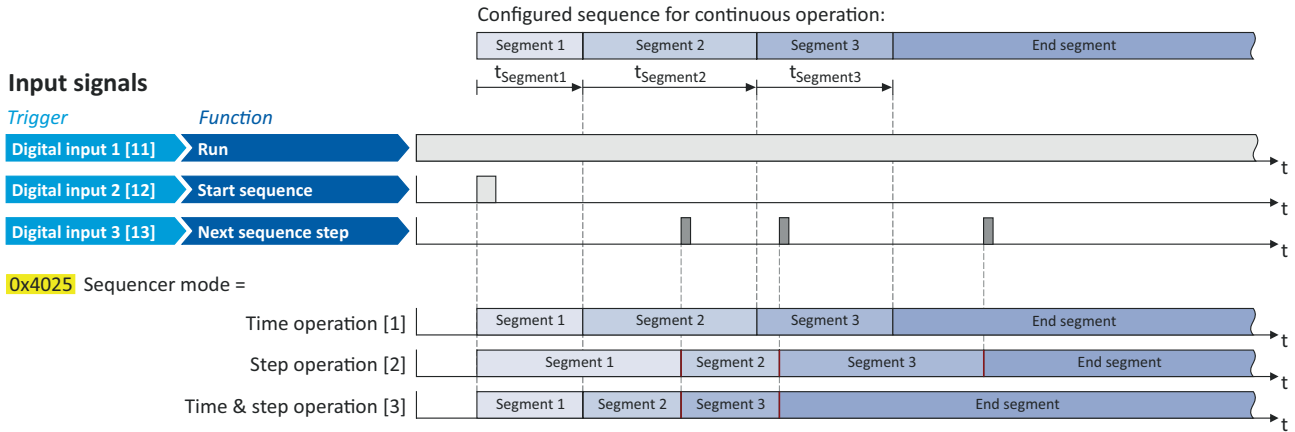

#### End of sequence mode 0x402F (P824.00)

- The end of sequence mode defines the action after the end of the sequence.
- In the default setting "Keep running [0]", the setpoint set for the end segment is continuously transmitted to the motor control until the sequence is aborted.
- The following diagram demonstrates the different end of sequence modes:

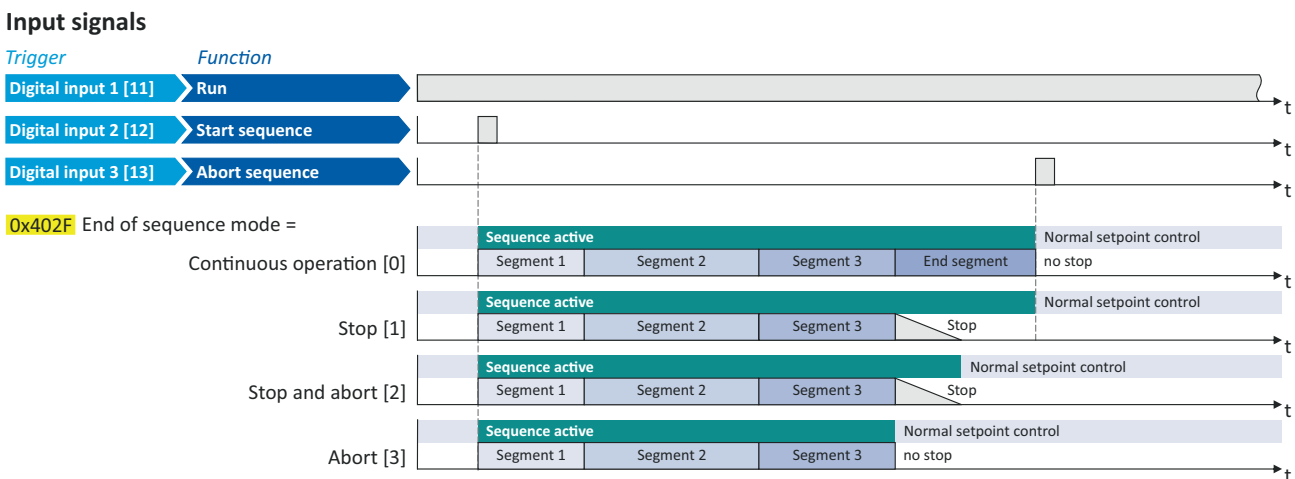

Start of sequence mode 0x4040 (P820.00)

- The start of sequence mode defines the action after the motor is stopped and restarted or after the motor has been restarted after an error occurred.
- In the default setting "Restart sequencer [0]", the currently selected sequence is restarted.
- The following diagram demonstrates the different start of sequence modes:

Configured sequence for continuous operation:



**Input signals**

Trigger Function

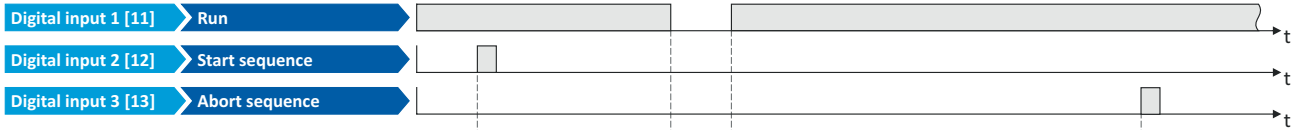

**0x4040** Start of sequence mode =

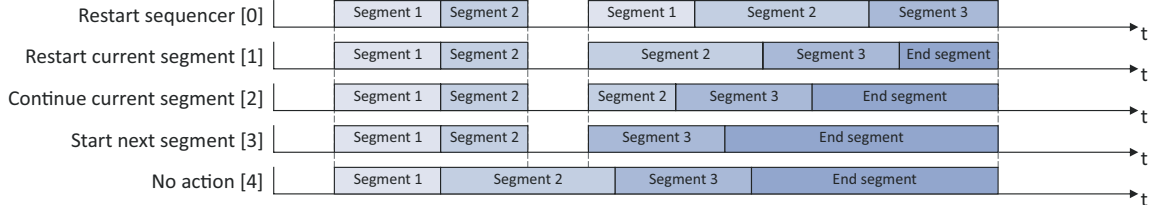

Parameter	Name / value range / [default setting]	Info
0x4025 (P800.00)	Sequencer mode (Sequencer mode)	Selection of the sequencer mode.
	<b>0 Disabled</b>	
	1 Time operation	The switch-over to the next step of the sequence is made after the time set for the current segment has elapsed.
	2 Step operation	The switch-over to the next step of the sequence is made via the trigger assigned in 0x2631:032 (P400.32) to the "Next sequence step" function.
0x402F (P824.00)	End of sequence mode (End of seq. mode)	Selection of the action after the sequence has been completed, i. e., after the steps configured for the sequence have been passed through with the set numbers of cycles.
	<b>0 Keep running</b>	The setpoint set for the end segment is continuously transmitted to the motor control until the sequence is aborted.
	1 Stop	The motor is stopped with the stop method set in 0x2838:003 (P203.03). The setpoint is continued to be controlled by the sequencer. In order to return to the normal setpoint control, the sequence must be aborted. <b>Note!</b> After returning to the normal setpoint control, a start command is required to restart the motor.
	2 Stop and abort	The motor is stopped with the stop method set in 0x2838:003 (P203.03). After standstill is reached, it is automatically returned to the normal setpoint control. <b>Note!</b> After returning to the normal setpoint control, a start command is required to restart the motor.
0x4040 (P820.00)	Start of sequence mode (StartOfSeq. mode)	Selection of the action after the motor has been stopped and restarted or after the motor has been restarted after an error occurred.
	<b>0 Restart sequencer</b>	The currently selected sequence is restarted.
	1 Restart current segment	The current segment of the selected sequence is restarted.
	2 Continue current segment	The current segment of the selected sequence is continued (just like after a break).
	3 Start next segment	The next segment of the selected sequence is started.
4 No action	For debugging purposes: The sequence is continued to be processed (including output states) even if the motor is stopped.	

## 12 FLEXIBLE I/O CONFIGURATION

Use parameter 0x2631 (P400xx) to individually adapt the variable speed drive control to the respective application. This is basically effected by assigning digital signal sources ("triggers") to function of the variable speed drive.

### NOTICE

A digital signal source can be assigned to several functions.

Possible consequence: unforeseeable behaviour of the drive in case of incorrect assignment.

- Carry out assignment of a digital signal source to several functions with greater care.

### Details

- Each subcode of 0x2631 (P400) is permanently assigned to a specific function.
- Functions are for example "Enable inverter", "Activate quick stop" or "Start forward (CW)".
- For a function, exactly one (digital) trigger can be set:



- Possible triggers to be selected are for example the digital input and internal status signals of the variable speed drive.
- A list of all triggers available can be found in the description for the parameter 0x2631:001 (P400.01).
- If the trigger condition is met, the corresponding function is executed. More details with regard to the respective trigger conditions can be gathered from the functional description in the following subchapters.

Example: changing the function assignment of a digital input

Task for this example:

1. The preset assignment of the digital input 3 for "Reverse rotational direction" function is to be cancelled.
2. Instead, the digital input 3 is to be assigned to the "Activate DC braking" function. For this purpose, the following two settings are required:

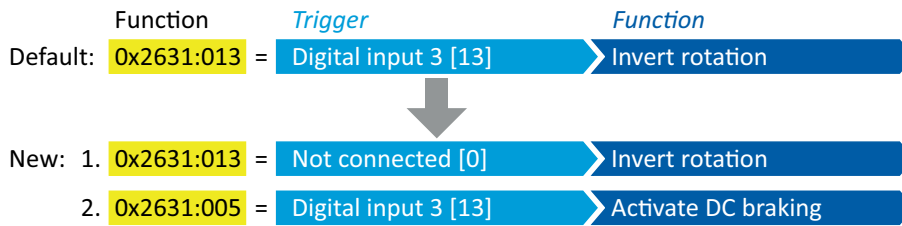

### 12.1 CONTROL SOURCE CHANGE-OVER

The term "control sources" in this connection refers to the digital signal sources from which the variable speed drive receives its start, stop, and reversal commands.

Possible control sources are:

- Digital inputs
- Keypad

### Details

First, select in 0x2824 (P200.00) whether the start of the motor is to be configured flexibly (default setting) or exclusively via the keypad. See chapter "Control source selection".

If "Flexible I/O configuration" is set, a change-over from one control source to another can be effected during operation via the functions listed in the following table. The variable speed drive not only supports such a change-over via its digital inputs, but also as a function of internal variable speed drive states.

Activate keypad control 0x2631:012 (P400.12)	Active control source
FALSE / Not connected	Flexible I/O configuration (default setting) – The motor is controlled via the digital inputs. – For preconfigured assignment of the digital inputs, see chapter "Function assignment of the inputs and outputs". – For description of the basic functions for controlling the motor, see chapter "Start / stop motor".
TRUE	Keypad – Starting the motor is only possible via the  keypad key. – Exception: Jog operation; see chapter "Start / stop motor". ► Example 1: Change-over from terminal control to keypad control.



- i** The "Enable inverter" 0x2631:001 (P400.01) function must be set to TRUE to start the motor. Either via digital input or by default setting "Constant TRUE [1]". If the function is set to FALSE, the variable speed drive is disabled. The motor becomes torqueless (coasts).  
In case of an activated keypad, the "Run" 0x2631:002(P400.02) function must be additionally set to TRUE to start the motor. Either via digital input or by the "Constant TRUE [1]" setting.

Notes:



- In case of an activated keypad control, the following functions are still active:
  - 0x2631:001 (P400.01): Enable inverter
  - 0x2631:002 (P400.02): Run
  - 0x2631:003 (P400.03): Activate quick stop
  - 0x2631:004 (P400.04): Reset fault
  - 0x2631:005 (P400.05): Activate DC braking
  - 0x2631:010 (P400.10): Jog forward (CW)
  - 0x2631:011 (P400.11): Jog reverse (CCW)
  - 0x2631:012 (P400.12): Activate keypad control
- Diagnostic parameters:
  - 0x282A:001 (P126.01): Cause of disable
  - 0x282A:002 (P126.02): Cause of quick stop
  - 0x282A:003 (P126.03): Cause of stop
  - 0x282B:001 (P125.01): Active control source

For description of the basic functions for controlling the motor, see chapter "Start / stop motor".

Parameter	Name / value range / [default setting]	Info
0x2631:012 (P400.12)	Function list: Activate keypad control (Function list: Keypad control) - For further possible settings, see parameter 0x2631:001 (P400.01).	Assignment of a trigger for the "Activate keypad control" function. Trigger = TRUE: activate keypad as control source. Trigger = FALSE: no action/ deactivate keypad as control source again.
	<b>0 Not connected</b>	

Parameter	Name / value range / [default setting]	Info
0x2824 (P200.00)	Control selection (Control select.)	Selection of the type of variable speed drive control.
	0 Flexible I/O configuration	This selection enables a flexible assignment of the start, stop, and rotating direction commands with digital signal sources. - Digital signal sources can be digital inputs and keypad. - The I/O configuration is made via the parameters 0x2631:xx (P400.xx).
	1 Keypad	This selection enables the motor to be started exclusively via the start key of the keypad. Other signal sources for starting the motor are ignored.  Start motor  Stop motor Note! - The functions "Enable inverter" 0x2631:001 (P400.01) and "Run" 0x2631:002 (P400.02) must be set to TRUE to start the motor. - If jog operation is active the motor cannot be stopped via  the keypad key.

### 12.1.1 EXAMPLE 1: CHANGE-OVER FROM TERMINAL CONTROL TO KEYPAD CONTROL

- The control is executed primarily via the I/O terminals: Switch S1 serves to start and stop the motor.
- Switch S2 serves to optionally change over to local keypad control. In case of activated keypad control, the motor can only be started via the  keypad key. However, the condition is that switch S1 is closed.
- If switch S1 is opened again or the  keypad key is pressed, the motor is stopped (irrespective of the active control source).

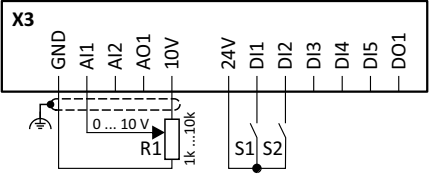
Connection plan	Function
	Potentiometer R1
	Frequency setpoint selection
	Switch S1
	Run
	Switch S2
	Activate keypad control

Parameter	Name	Setting for this example
0x2631:001 (P400.01)	Enable inverter	Constant TRUE [1]
0x2631:002 (P400.02)	Run	Digital input 1 [11]
0x2631:004 (P400.04)	Reset fault	Not connected [0]
0x2631:012 (P400.12)	Activate keypad control	Digital input 2 [12]
0x2824 (P200.00)	Control selection	Flexible I/O configuration [0]

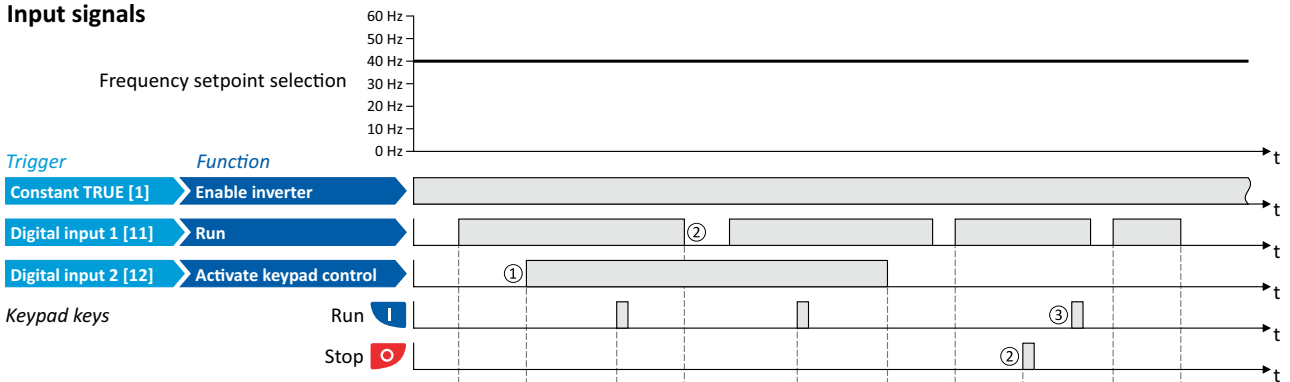

#### Input signals

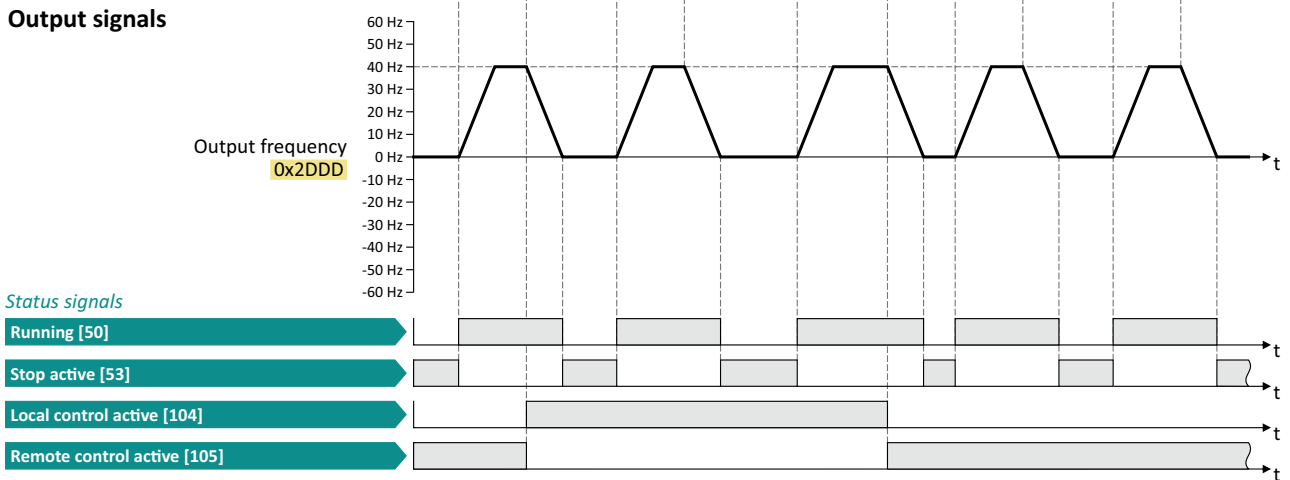

#### Output signals



The status signals can be assigned to digital outputs. ▶ See chapter "Configuration of digital outputs".

- ① When changing over to another control source, the motor is first stopped with the stop method set in 0x2838:003 (P203.03).
- ② The motor will also be stopped if the "Run" function is deactivated or  keypad key is pressed (irrespective of the active control the source).
- ③ After stopping with the  keypad key and before a renewed start command from another control source, the  key on the keypad must be pressed to cancel the keypad stop again ("KSTOP").

## 12.2 START / STOP MOTOR

Configuration of the triggers for the basic functions for controlling the motor.

### Details

The following table contains a short overview of the basic functions. For more details see the following parameter descriptions.



Function	Info
Enable inverter 0x2631:001 (P400.01)	Enable/disable operation. – The function must be set to TRUE to start the motor. Either via digital input or by default setting "Constant TRUE [1]". – If the function is set to FALSE, the variable speed drive is disabled. The motor becomes torqueless (coasts). ▶ See Example 4: Enable inverter.
Run 0x2631:002 (P400.02)	TRUE: Let motor rotate forward (CW). FALSE: Stop motor. ▶ See Example 1: Start/stop (1 signal) and reversal.
Activate quick stop 0x2631:003 (P400.03)	Bring motor to a standstill in best time ▶ See Example 2: Quick stop.
Jog forward (CW) 0x2631:010 (P400.10)	Jog operation: Let the motor rotate in a status-controlled way with setpoint preset.
Jog reverse (CCW) 0x2631:011 (P400.11)	<b>CAUTION!</b> The jog operation has a higher priority than the "Run" function all other start commands and the keypad key  . – If jog operation is active, the motor cannot be stopped with the previously mentioned functions! – However, jog operation can be interrupted by the "Quick stop" function. – Jog operation can always be activated, even in case of keypad control. ▶ See Example 3: Jog forward/Jog reverse.
Reverse rotational direction 0x2631:013 (P400.13)	Invert frequency setpoint. – Function can be used in combination with all start commands. ▶ See Example 1: Start/stop (1 signal) and reversal.

### Assignment guidelines

The error message "Trigger/function connected incorrectly" (error code 25216 | 0x6280) is output if one of the following assignment guidelines is not observed:

- If the "flexible I/O configuration" is active as control source, the "Enable inverter" function or the "Run" function must be connected to a digital input in order that the motor can be stopped again any time!
- In case of keypad control, the two functions "Enable inverter" and "Run" can also be set to "Constant TRUE [1]" to start the motor.

Parameter	Name / value range / [default setting]	Info
0x2631:001 (P400.01)	Function list: Enable inverter (Function list: Enable inverter) – Setting can only be changed if the variable speed drive is inhibited.	Assignment of a trigger for the "Enable inverter" function. Trigger = TRUE: The inverter is enabled (unless there is another cause for inverter disable). Trigger = FALSE: The variable speed drive is disabled. Notes: – This function must be set to TRUE to start the motor. Either via an assigned digital input or by default setting "Constant TRUE [1]". – Changing to the inhibited state causes an immediate stop of the motor, regardless of the stop method set in 0x2838:003 (P203.03). The motor becomes torqueless and coasts down as a function of the mass inertia of the machine. – The cause(s) that are active for the disabled state are shown in 0x282A:001 (P126.01).
0	Not connected	No trigger assigned (trigger is constantly FALSE).
1	Constant TRUE	Trigger is constantly TRUE.
11	Digital input 1	State of X3/DI1, taking an inversion set in 0x2632:001 (P411.01) into consideration.
12	Digital input 2	State of X3/DI2, taking an inversion set in 0x2632:002 (P411.02) into consideration.
13	Digital input 3	State of X3/DI3, taking an inversion set in 0x2632:003 (P411.03) into consideration.
14	Digital input 4	State of X3/DI4, taking an inversion set in 0x2632:004 (P411.04) into consideration.
15	Digital input 5	State of X3/DI5, taking an inversion set in 0x2632:005 (P411.05) into consideration.
50	Running	TRUE if inverter and start are enabled and output frequency > 0.2 Hz. Otherwise FALSE.
51	Ready for operation	TRUE if variable speed drive is ready for operation (no error active and DC-bus voltage ok). Otherwise FALSE.
53	Stop active	TRUE if variable speed drive is enabled and motor is not started and output frequency = 0.
54	Quick stop active	TRUE if quick stop is active. Otherwise FALSE.
58	Device warning active	TRUE if warning is active. Otherwise FALSE. – A warning has no impact on the operating status of the drive. – A warning is reset automatically if the cause has been eliminated.
59	Device fault active	TRUE if a fault is active. Otherwise FALSE. – In the event of a fault, the motor is brought to a standstill with the quick stop ramp. The variable speed drive is then disabled. – Exception: In case of a serious fault, the variable speed drive is disabled immediately. The motor becomes torqueless (coasts). – The error state will be left automaticall if the error condition is not active anymore. – The restart behaviour after trouble can be configured ▶ See chapter "Automatic restart".
60	Heatsink temperature warning active	TRUE if current heatsink temperature > warning threshold for temperature monitoring. Otherwise FALSE. – Display of the current heatsink temperature in 0x2D84:001 (P117.01). – Setting of the warning threshold in 0x2D84:002.
69	Rotational direction reversed	TRUE if output frequency is negative. Otherwise FALSE.
70	Frequency threshold exceeded	TRUE if current output frequency > frequency threshold. Otherwise FALSE. – Display of the current output frequency in 0x2DDD (P100.00). – Setting Frequency threshold in 0x4005 (P412.00). ▶ See "Frequency threshold for "Frequency threshold exceeded" trigger"
71	Actual speed = 0	TRUE if current output frequency = 0 Hz (± 0.01 Hz), irrespective of the operating mode. Otherwise FALSE. – Display of the current output frequency in 0x2DDD (P100.00).
78	Current limit reached	TRUE if current motor current ≥ maximum current. Otherwise FALSE. – Display of the present motor current in 0x2D88 (P104.00). – Setting for the maximum current in 0x6073 (P324.00).
79	Torque limit reached	TRUE if torque limit has been reached or exceeded. Otherwise FALSE. – Setting "Positive torque limit" in 0x60E0. – Setting "Negative torque limit" in 0x60E1.
81	Error of analog input 1 active	TRUE if the monitoring of the input signal at the analog input 1 has responded. Otherwise FALSE. This trigger is set as a function of the following settings: – Monitoring threshold 0x2636:008 (P430.08) – Monitoring condition 0x2636:009 (P430.09) The setting of the Error response in 0x2636:010 (P430.10) has no effect on this trigger. ▶ See chapter "Analog input 1".
82	Error of analog input 2 active	TRUE if the monitoring of the input signal at the analog input 2 has responded. Otherwise FALSE. This trigger is set as a function of the following settings: – Monitoring threshold 0x2637:008 (P431.08) – Monitoring condition 0x2637:009 (P431.09) The setting of the Error response in 0x2637:010 (P431.10) has no effect on this trigger. ▶ See chapter "Analog input 2".
83	Load loss detected	TRUE if actual motor current < threshold for load loss detection after delay time of the load loss detection has elapsed. Otherwise FALSE. – Display of the present motor current in 0x6078 (P103.00). – Setting Threshold in 0x4006:001 (P710.01). – Setting Deceleration 0x4006:002 (P710.02). ▶ Load loss detection
102	Sequence suspended	Status signal of the "sequencer" function: TRUE if the sequence is currently suspended. ▶ See chapter "Sequencer".
103	Sequence done	Status signal of the "sequencer" function: TRUE if the sequence is completed (final segment has been passed through). ▶ See chapter "Sequencer".
104	Local control active	TRUE if local keypad control ("LOC") active. Otherwise FALSE.
105	Remote control active	TRUE if remote control ("REM") via terminals, etc. active. Otherwise FALSE.
106	Manual setpoint selection active	TRUE if manual setpoint selection ("MAN") via keypad active. Otherwise FALSE. – Selection of the trigger for the "Activate keypad setpoint" function in 0x2631:016 (P400.16).
107	Automatic setpoint selection active	TRUE if automatic setpoint selection ("AUTO") via terminals, etc. active. Otherwise FALSE.

Parameter	Name / value range / [default setting]	Info
0x2631:002 (P400.02)	Function list: Run (Function list: Run) – Setting can only be changed if the variable speed drive is inhibited. – For further possible settings see parameter 0x2631:001 (P400.01).	Assignment of a trigger for the "Run" function.  <b>Function 1: Start / stop motor (default setting)</b> Function 1 is active if no further start commands have been connected to triggers and no keypad control is active. Trigger = TRUE: Let motor rotate forward (CW). Trigger = FALSE: Stop motor.  Notes to function 1: – If "Enable inverter" 0x2631:001 (P400.01) is set = "Constant TRUE [1]", the only permissible trigger for this function is a digital input in order that the motor can be stopped again any time. – The stop method can be selected in 0x2838:003 (P203.03). – The function also serves to realise an automatic start after switch- on. ► See chapter "Starting performance".  <b>Function 2: Start enable/stop motor</b> Function 2 is active if further start commands have been connected to triggers or keypad control is active. Trigger = TRUE: Start commands of the active control source are enabled. Trigger = FALSE: Stop motor.  Notes to function 2: – If no separate start enable is required for the application the trigger "Constant TRUE [1]" must be set. – The stop method can be selected in 0x2838:003 (P203.03). Assignment of a trigger for the "Run" function. Trigger = FALSE-TRUE edge: Drive is started in forward rotating direction (CW) if the following conditions are fulfilled: – Controller is enabled and no error or quick stop are active. – No other start command is configured Trigger = TRUE-FALSE edge: drive is stopped again.
	<b>11</b> Digital input 1	
0x2631:003 (P400.03)	Function list: Activate quick stop (Function list: Quick stop) – Setting can only be changed if the variable speed drive is inhibited. – For further possible settings, see parameter 0x2631:001 (P400.01).	Assignment of a trigger for the "Activate quick stop" function. Trigger = TRUE: Activate quick stop. Trigger = FALSE: Deactivate quick stop.  Notes: – The "Quick stop" function brings the motor to a standstill within the deceleration time set in 0x291C (P225.00).
	<b>0</b> Not connected	
0x2631:010 (P400.10)	Function list: Jog forward (CW) (Function list: Jog forward) – Setting can only be changed if the variable speed drive is inhibited. – For further possible settings see parameter 0x2631:001 (P400.01).	Assignment of a trigger for the "Jog forward (CW)" function. Trigger = TRUE: Let motor rotate forward with preset 5. Trigger = FALSE: Stop motor.  <b>CAUTION!</b> The jog operation has a higher priority than the "Run" function all other start commands and the keypad key  . – If jog operation is active the motor cannot be stopped with the previously mentioned functions! – However, jog operation can be interrupted by the "Quick stop" function.  Notes: – The preset value 5 can be set in 0x2911:005 (P450.05). – The stop method can be selected in 0x2838:003 (P203.03). – If "Jog forward (CW)" and "Jog reverse (CCW)" are activated at the same time, the motor is stopped using the stop method and jog operation must be triggered again. – Jog operation cannot be started automatically. The "Start at power- up" option in 0x2838:002 (P203.02) does not apply to jog operation.
	<b>0</b> Not connected	
0x2631:011 (P400.11)	Function list: Jog reverse (CCW) (Function list: Jog reverse) – Setting can only be changed if the variable speed drive is inhibited. – For further possible settings, see parameter 0x2631:001 (P400.01).	Assignment of a trigger for the "Jog reverse (CCW)" function. Trigger = TRUE: Let motor rotate backward with preset 6. Trigger = FALSE: Stop motor.  <b>CAUTION!</b> The jog operation has a higher priority than the "Run" function all other start commands and the keypad key  . – If jog operation is active the motor cannot be stopped with the previously mentioned functions! – However, jog operation can be interrupted by the "Quick stop" function.  Notes: – The preset value 6 can be set in 0x2911:006 (P450.06). – The stop method can be selected in 0x2838:003 (P203.03). – If "Jog forward (CW)" and "Jog reverse (CCW)" are activated at the same time, the motor is stopped using the stop method and jog operation must be triggered again. – Jog operation cannot be started automatically. The "Start at power- up" option in 0x2838:002 (P203.02) does not apply to jog operation.
	<b>0</b> Not connected	
0x2631:013 (P400.13)	Function list: Reverse rotational direction (Function list: Reverse rot.dir.) – Setting can only be changed if the variable speed drive is inhibited. – For further possible settings, see parameter 0x2631:001 (P400.01).	Assignment of a trigger for the "Reverse rotational direction" function. Trigger = TRUE: the setpoint specified is inverted (i. e. the sign is inverted). Trigger = FALSE: no action / deactivate function again.
	<b>13</b> Digital input 3	



### 12.2.1 EXAMPLE 1: START/STOP (1 SIGNAL) AND REVERSAL

This example shows a simple control option via two switches which should be sufficient for many applications:

- Switch S1 starts the motor in forward direction of rotation. Switch S1 in the initial position stops the motor again.

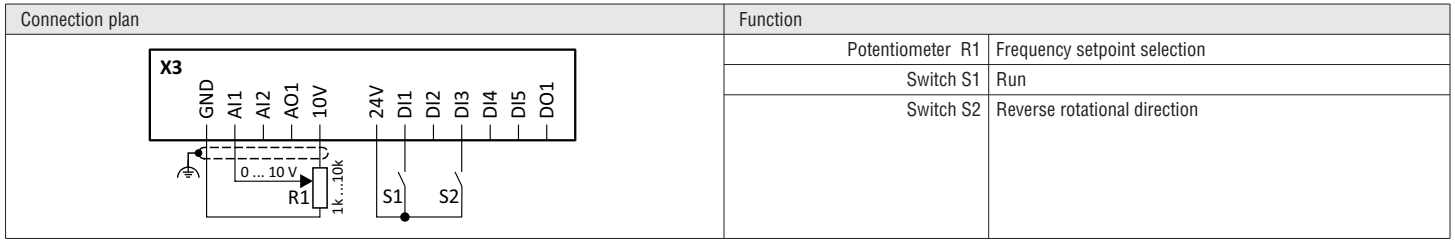

Parameter	Name	Setting for this example (corresponds to default setting)
0x2631:001 (P400.01)	Enable inverter	Constant TRUE [1]
0x2631:002 (P400.02)	Run	Digital input 1 [11]
0x2631:013 (P400.13)	Reverse rotational direction	Digital input 3 [13]

#### Input signals

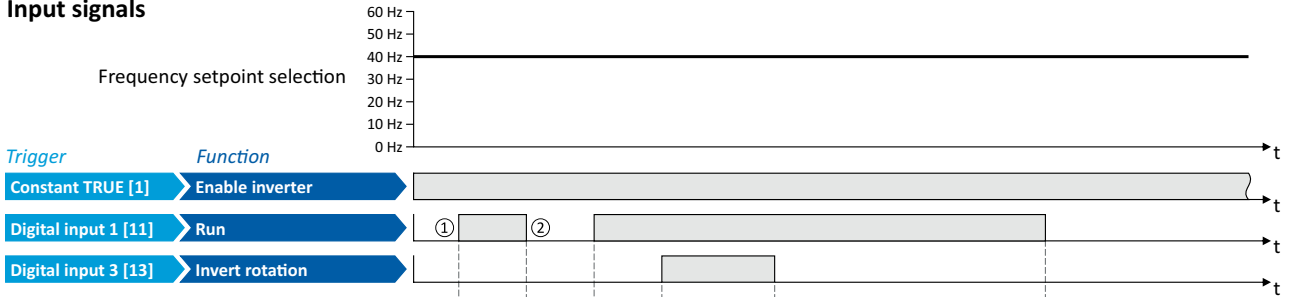

#### Output signals

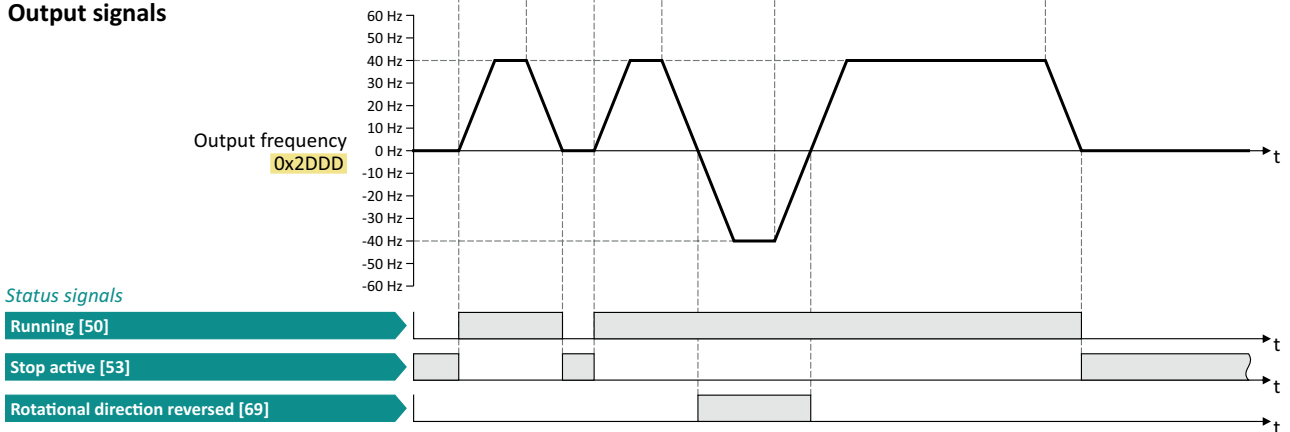

The status signals can be assigned to digital outputs. ▶ See chapter "Configuration of digital outputs".

- ① If the variable speed drive is enabled and no error is active, the motor can be started with the "Run" function in forward rotating direction.
- ② If "Run" is set to FALSE, the motor is stopped with the stop method set in 0x2838:003 (P203.03). In the example: Stop with standard ramp.

### 12.2.4 EXAMPLE 2: QUICK STOP

This example illustrates the "quick stop" function. If quick stop is activated the motor is brought to a standstill within the deceleration time set in 0x291C (P225.00).

- Switch S1 starts the motor in forward direction of rotation. Switch S1 in the initial position stops the motor again.
- Switch S2 activates the "quick stop" function.

**i** Cancelling the quick stop causes a restart of the motor if "Run" is still active (switch S1 closed)!

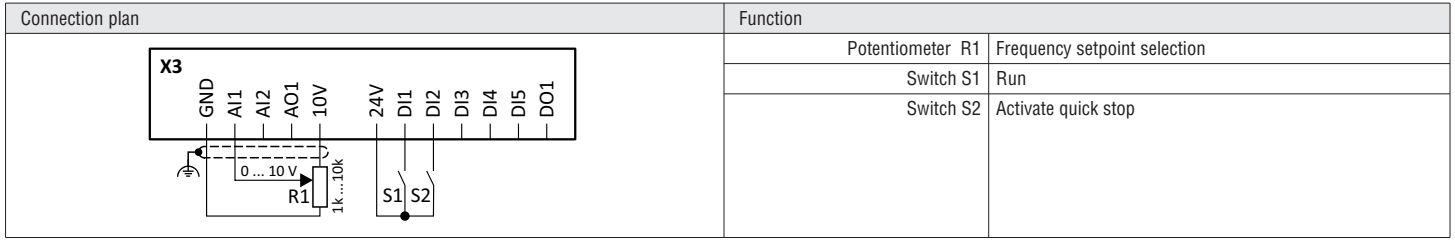

Parameter	Name	Setting for this example
0x2631:001 (P400.01)	Enable inverter	Constant TRUE [1]
0x2631:002 (P400.02)	Run	Digital input 1 [11]
0x2631:003 (P400.03)	Activate quick stop	Digital input 2 [12]
0x2631:004 (P400.04)	Reset fault	Not connected [0]
0x2917 (P220.00)	Acceleration time 1	3.0 s
0x2918 (P221.00)	Deceleration time 1	3.0 s
0x291C (P225.00)	Quick stop deceleration time	1.0 s

#### Input signals

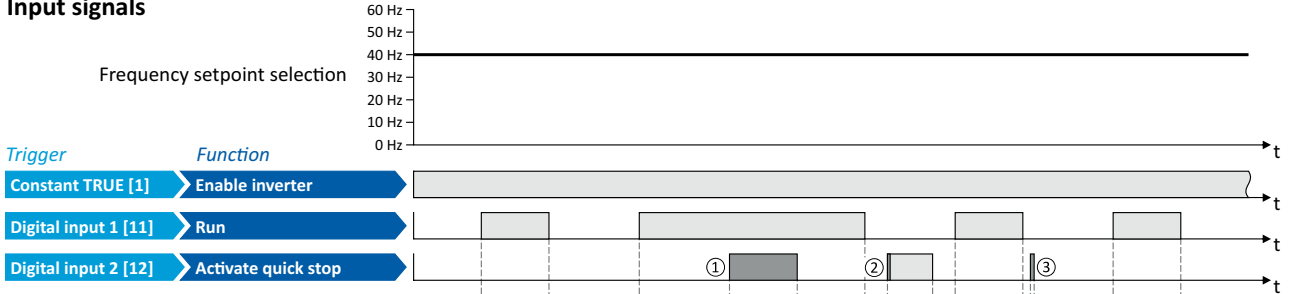

#### Output signals

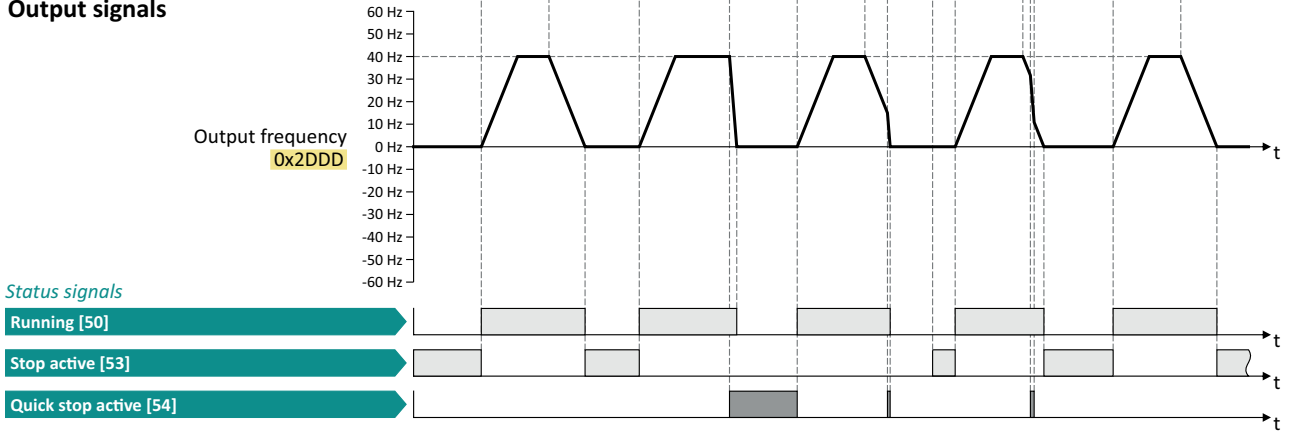

The status signals can be assigned to digital outputs. ▶ See chapter "Configuration of digital outputs".

- ① If quick stop is activated, the motor is decelerated to the frequency setpoint 0 Hz within a short period of time. The "Quick stop active[54]" status is set as long as quick stop is activated. The "Stop active [53]" status is not set.
- ② An active stop command is interrupted by a quick stop.
- ③ If quick stop is cancelled again before standstill is reached, stopping is continued with the stop method set in 0x2838:003 (P203.03). In the example: Stop with standard ramp.

### 12.2.5 EXAMPLE 3: JOG FORWARD/JOE REVERSE

This example illustrates the functions "Jog forward (CW)" and "Jog reverse (CCW)" for Jog operation.

- Switch S1 starts the motor in forward direction of rotation. Switch S1 in the initial position stops the motor again.
- Button S2 starts the motor in forward direction of rotation with frequency preset 5.
- Button S3 starts the motor in backward direction of rotation with frequency preset 6.
- The motor rotates in jog operation as long as the respective button is pressed. If both buttons are pressed at the same time, the motor is stopped.

#### NOTICE

The jog operation has a higher priority than the "Run" function, all other start commands and the keypad key .

If jog operation is active, the motor cannot be stopped with the previously mentioned functions.

- ▶ The jog operation is stopped by cancelling the functions "Jog forward (CW)"/"Jog reverse (CCW)".
- ▶ The jog operation can be interrupted with the "Activate quick stop" 0x2631:(P400.03) function.

1585 GB 09 18

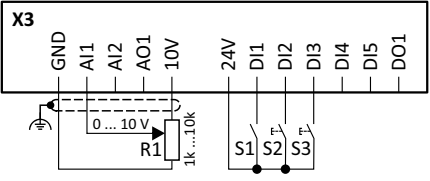
Connection plan	Function
	Potentiometer R1
	Frequency setpoint selection
	Switch S1
	Button S3

Parameter	Name	Setting for this example
0x2631:001 (P400.01)	Enable inverter	Constant TRUE [1]
0x2631:002 (P400.02)	Run	Digital input 1 [11]
0x2631:004 (P400.04)	Reset fault	Not connected [0]
0x2631:010 (P400.10)	Jog forward (CW)	Digital input 2 [12]
0x2631:011 (P400.11)	Jog reverse (CCW)	Digital input 3 [13]
0x2631:013 (P400.13)	Reverse rotational direction	Not connected [0]
0x2911:005 (P450.05)	Frequency setpoint presets: Preset 5	15 Hz (is used for jog forward)
0x2911:006 (P450.06)	Frequency setpoint presets: Preset 6	10 Hz (is used for jog reverse)

#### Input signals

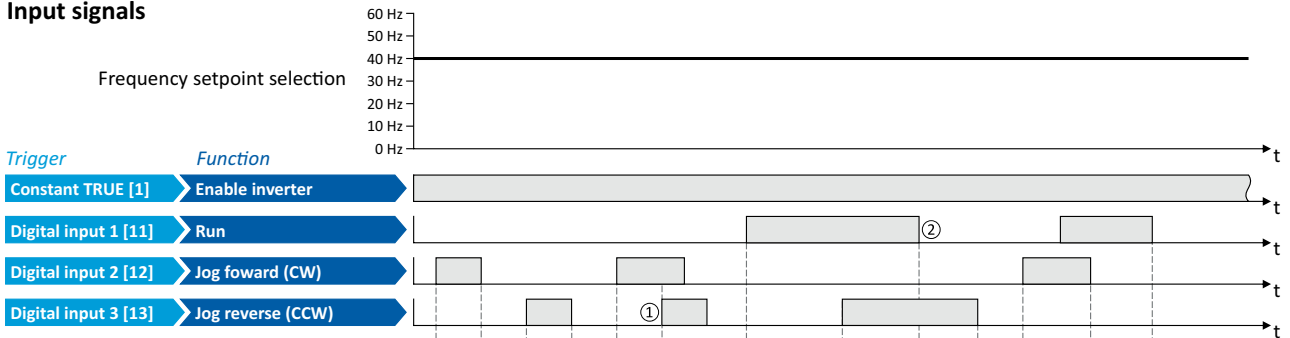

#### Output signals

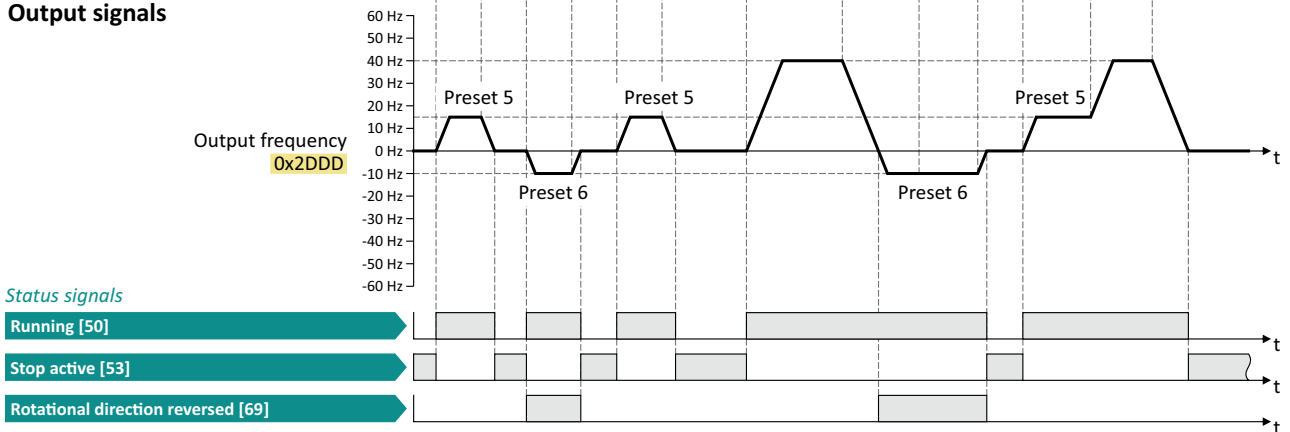

The status signals can be assigned to digital outputs. ▶ See chapter "Configuration of digital outputs".

- ① If "Jog forward (CW)" and "Jog reverse (CCW)" are activated at the same time, the motor is stopped with the stop method set in 0x2838:003 (P203.03) and the jog operation must be triggered again.
- ② The jog operation cannot be terminated with the "Run" function but only by cancelling the jog command.

### 12.2.6 EXAMPLE 4: ENABLE INVERTER

This example shows how to use the "Enable inverter" function for a separate enable input.

- In idle state of switch S1 (normally-closed contact), "Enable inverter" is already available.
- Switch S2 starts the motor in forward rotating direction (if switch S1 is closed). Switch S2 in initial position stops the motor again.
- Switch S1 disables the variable speed drive. The motor becomes torqueless (coasts).

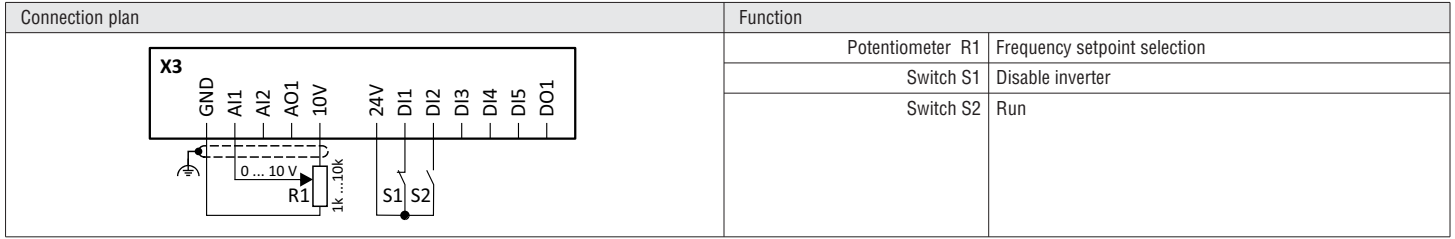

Parameter	Name	Setting for this example
0x2631:001 (P400.01)	Enable inverter	Digital input 1 [11]
0x2631:002 (P400.02)	Run	Digital input 2 [12]
0x2631:004 (P400.04)	Reset fault	Not connected [0]

#### Input signals

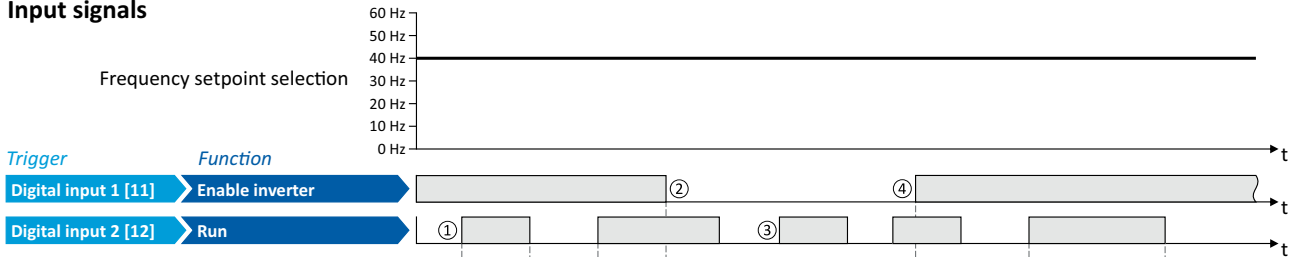

#### Output signals

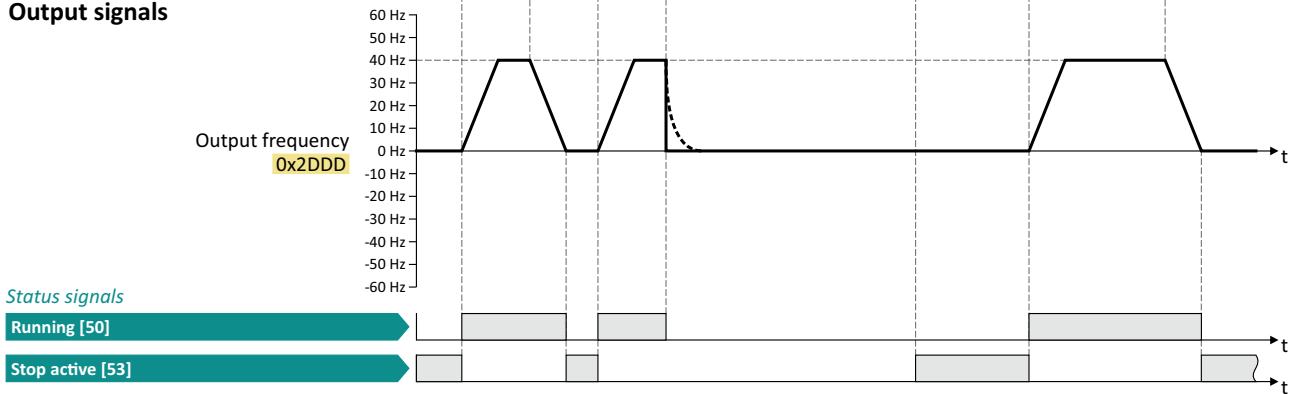

The status signals can be assigned to digital outputs. ▶ See chapter "Configuration of digital outputs".

- ① If the variable speed drive is enabled and no error is active, the motor can be started with the "Run" function in forward rotating direction.
- ② If "Enable inverter" is set to FALSE, the variable speed drive is disabled. The motor becomes torqueless and coasts to standstill as a function of the mass inertia of the machine.
- ③ Without "Enable inverter", the motor cannot be started.
- ④ In the default setting, the motor does not start if the "Run" function is set to TRUE during "Enable inverter". After "Enable inverter", must be retriggered to start the motor.
  - ▶ See chapter "Starting performance".

### 12.3 SETPOINT CHANGE-OVER

The variable speed drive receives its setpoint from the selected standard setpoint source. Corresponding functions make it possible to change over to other setpoint sources during operation.

Possible setpoint sources are:

- Analog inputs
- Keypad
- Parameterisable setpoints (presets)
- "Motor potentiometer" function
- "Sequencer" function.

#### Details

For applications only requiring one setpoint it is sufficient to define the standard setpoint source in the following parameters:

- 0x2860:001 (P201.01): Frequency control: Default setpoint source
- 0x2860:002 (P201.02): PID control: Default setpoint source
- 0x2860:003 (P201.03): Torque control: Default setpoint source

For a setpoint change-over during operation, the following functions must be configured.

For details and examples see the following subchapters.

Function	Info
Activate AI1 setpoint 0x2631:014 (P400.14)	Activate analog input 1 / analog input 2 as setpoint source. ▶ See chapter "Analog input setpoint source".
Activate AI2 setpoint 0x2631:015 (P400.15)	
Activate keypad setpoint 0x2631:016 (P400.16)	Activate keypad as setpoint source. - The keypad setpoint can be changed in the operating mode via the navigation keys ↑ and ↓ keypad key. ▶ See chapter "Keypad setpoint source".
Activate preset (bit 0) 0x2631:018 (P400.18)	Activate parameterisable setpoints (presets) as setpoint source. - 15 frequency setpoints and 8 PID setpoints can be set as presets. - A preset can be selected binary-coded via the four functions "Activate preset (bit 0)" ... "Activate preset (bit 3)". ▶ See chapter "Setpoint source of preset setpoints".
Activate preset (bit 1) 0x2631:019 (P400.19)	
Activate preset (bit 2) 0x2631:020 (P400.20)	
Activate preset (bit 3) 0x2631:021 (P400.21)	
Activate MOP setpoint 0x2631:025 (P400.25)	The "Motor potentiometer" function can be used as an alternative setpoint control that is controlled via two functions "MOP setpoint up" and "MOP setpoint down". ▶ See chapter "Motor potentiometer" setpoint source (MOP).
Activate segment setpoint (bit 0) 0x2631:026 (P400.26)	Activate parameterisable segment setpoints as setpoint source. The four functions "Activate segment setpoint (bit 0)" ... "Activate segment setpoint (bit 3)" enable a setpoint change-over to a segment setpoint parameterised for the "sequencer" function during normal operation. ▶ See chapter "Setpoint source segment setpoints".
Activate segment setpoint (bit 1) 0x2631:027 (P400.27)	
Activate segment setpoint (bit 2) 0x2631:028 (P400.28)	
Activate segment setpoint (bit 3) 0x2631:029 (P400.29)	

The following signal flow shows the internal setpoint logics:

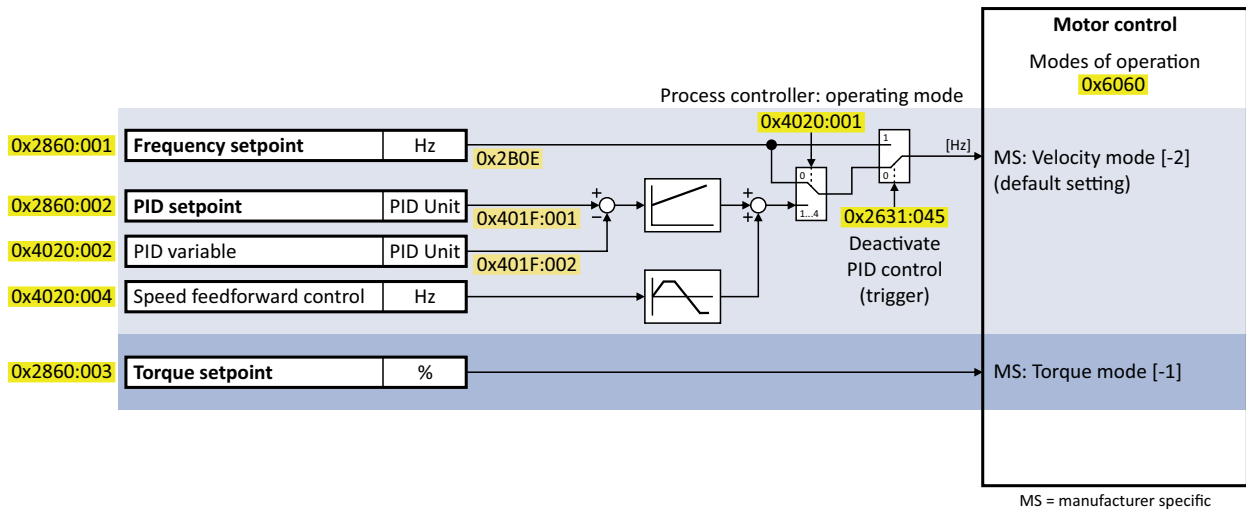

#### Notes:

- The setpoint used by the motor control depends on the operating mode selected in 0x6060 (P301.00):
  - "MS: Velocity mode [-2]": The active frequency setpoint is used. In addition, the PID control can be activated in 0x4020:001 (P600.01).
    - ▶ Configuring the process controller.
  - "MS: Torque mode [-1]": The active torque setpoint is used.
    - ▶ See chapter "Torque control w/ freq. limit".
- As only one setpoint source can be active at a time priorities are assigned to the frequency PID and torque setpoint sources. For details see the following subchapter "Priority of the setpoint sources"

#### Diagnostic parameters:

- 0x282B:002 (P125.02): Active setpoint source.

### 12.3.1 PRIORITY OF THE SETPOINT SOURCES

Since only one setpoint source can be active at a time the following priorities apply:

Flexible I/O configuration or keypad control active
<p>Prio 1: Functions for setpoint change-over The priority of the functions results from the assigned triggers (in the order of the selection list):</p> <ol style="list-style-type: none"> <li>1. Constant TRUE [1]</li> <li>2. Digital input 1 [11]</li> <li>3. Digital input 2 [12]</li> <li>4. Digital input 3 [13]</li> <li>5. ...</li> </ol> <p>Prio 2: Set standard setpoint source</p> <ul style="list-style-type: none"> <li>– 0x2860:001 (P201.01): Frequency control: Default setpoint source</li> <li>– 0x2860:002 (P201.02): PID control: Default setpoint source</li> </ul> <p>► See chapter "Selection of setpoint source".</p>

1585 GB 09 18

Parameter	Name	Setting for this example
0x2631:014 (P400.14)	Activate AI1 setpoint	Digital input 5 [15]
0x2631:016 (P400.16)	Activate keypad setpoint	Digital input 4 [14]

Digital input 4	Digital input 5	Active setpoint source
FALSE	FALSE	Standard setpoint source set in 0x2860:001 (P201.01)
FALSE	TRUE	Analog input 1
TRUE	FALSE	keypad
TRUE	TRUE	Keypad (since "Digital input 4" trigger is higher in the selection list than "Digital input 5" trigger)

### 12.3.2 ANALOG INPUT SETPOINT SOURCE

The following functions are used to select analog input 1 or analog input 2 as setpoint source.

#### Preconditions

A setpoint change-over to the respective analog input is only effected if no setpoint source with a higher priority has been selected.

► See chapter "Priority of the setpoint sources".

Parameter	Name / value range / [default setting]	Info
0x2631:014 (P400.14)	<p>Function list: Activat AI1 setpoint (Function list: Setp: AI1)</p> <p>– For further possible settings, see parameter 0x2631:001 (P400.01).</p> <p><b>0</b>   <b>Not connected</b></p>	<p>Assignment of a trigger for the "Activate AI1 setpoint" function. Trigger = TRUE: analog input 1 is used as setpoint source (if the trigger assigned has the highest setpoint priority). Trigger = FALSE: no action / deactivate function again.</p> <p>► See chapter "Analog input 1".</p>

Parameter	Name / value range / [default setting]	Info
0x2631:015 (P400.15)	Function list: Activate AI2 setpoint (Function list: Setp: AI2) – For further possible settings, see parameter 0x2631:001 (P400.01).	Assignment of a trigger for the "Activate AI2 setpoint" function. Trigger = TRUE: analog input 1 is used as setpoint source (if the trigger assigned has the highest setpoint priority). Trigger = FALSE: no action / deactivate function again. ► See chapter "Analog input 2".
	<b>0</b>   Not connected	

1585 GB 09 18

- Example for operating mode
- The keypad is set as standard setpoint source.
  - Switch S1 starts the motor in forward direction of rotation. Switch S1 in the initial position stops the motor again.
  - Switch S2 switches the direction of rotation
  - Switch S3 activates analog input 1 as setpoint source.
  - Switch S4 activates analog input 2 as setpoint source.

**i** If S3 and S4 are operated at the same time, the analog input 1 is active as setpoint source since the digital input 3 assigned to this function has a higher priority than the digital input 4.

Connection plan	Function
	Potentiometer R1   Frequency setpoint selection via AI1
	Potentiometer R2   Frequency setpoint selection via AI2
	Switch S1   Run
	Switch S2   Reverse rotational direction
	Switch S3   Activate AI1 setpoint
	Switch S4   Activate AI2 setpoint

Parameter	Name	Setting for this example
0x2631:001 (P400.01)	Enable inverter	Constant TRUE [1]
0x2631:002 (P400.02)	Run	Digital input 1 [11]
0x2631:004 (P400.04)	Reset fault	Not connected [0]
0x2631:013 (P400.13)	Reverse rotational direction	Digital input 2 [12]
0x2631:014 (P400.14)	Activate AI1 setpoint	Digital input 3 [13]
0x2631:015 (P400.15)	Activate AI2 setpoint	Digital input 4 [14]
0x2631:018 (P400.18)	Activate preset (bit 0)	Not connected [0]
0x2824 (P200.00)	Control selection	Flexible I/O configuration [0]
0x2838:003 (P203.03)	Stop method	Standard ramp [1]
0x2860:001 (P201.01)	Frequency control: Default setpoint source	Keypad [1]

**Input signals**

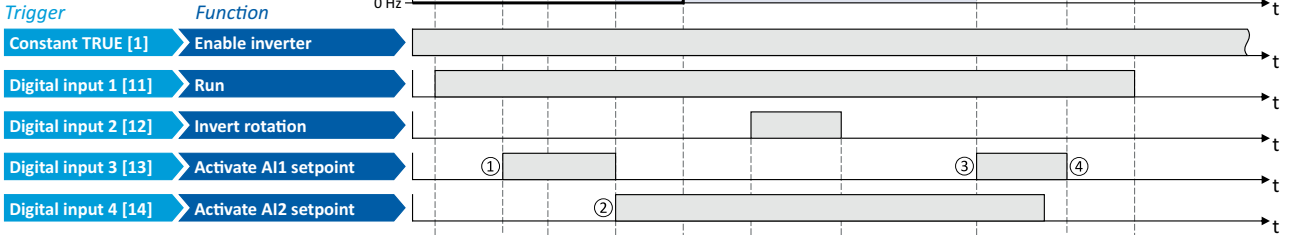
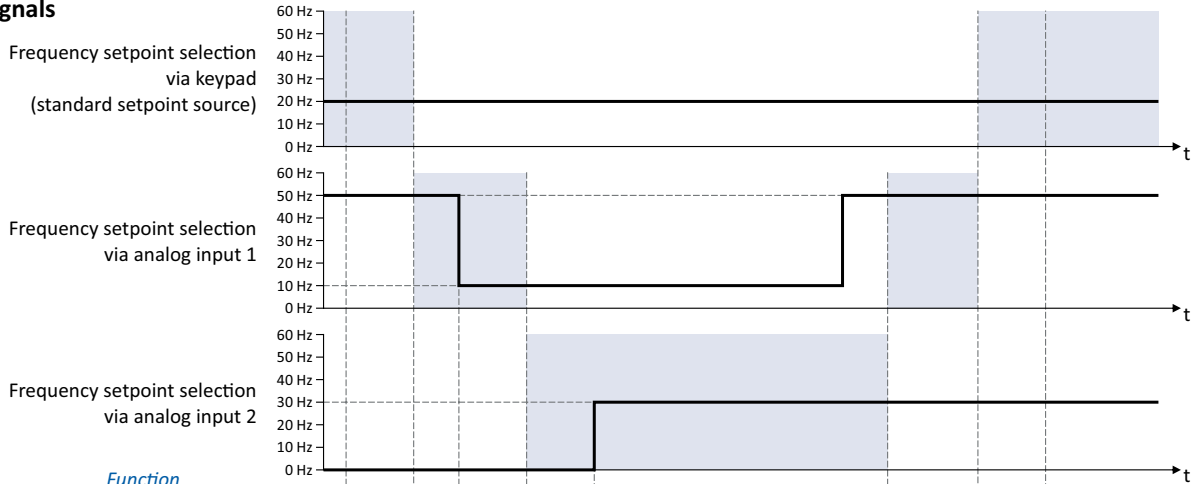

**Output signals**

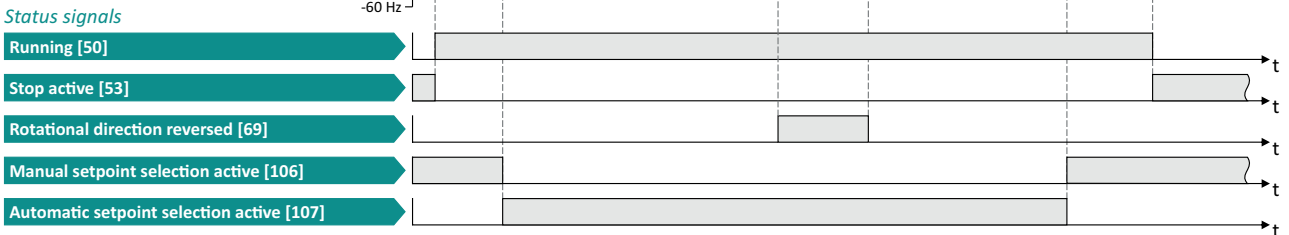
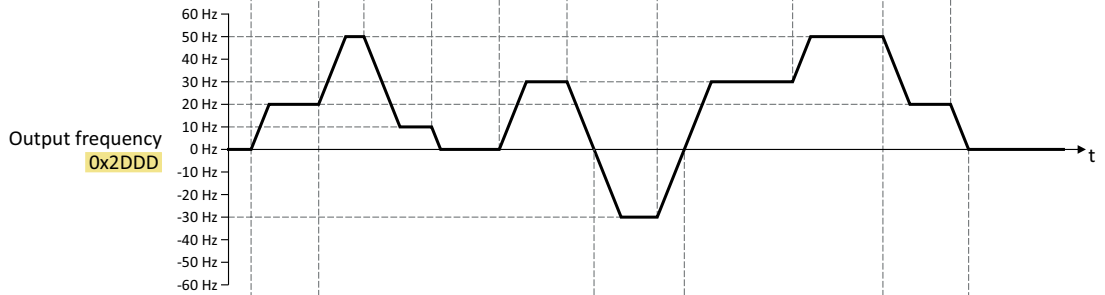

The status signals can be assigned to digital outputs. ▶ See chapter "Configuration of digital outputs".

- ① Change-over from keypad setpoint (standard setpoint source) to AI1 setpoint.
- ② Change-over from AI1 setpoint to AI2 setpoint.
- ③ Change-over from AI2 setpoint to AI1 setpoint since the digital input 3 has a higher priority than the digital input 4.
- ④ Change-over to keypad setpoint (standard setpoint source).



### 12.3.3 KEYPAD SETPOINT SOURCE

The following function is used to select the keypad as setpoint source.

#### Preconditions

A setpoint change-over to the keypad is only effected if no setpoint source with a higher priority has been selected. ► See chapter "Priority of the setpoint sources".

Parameter	Name / value range / [default setting]	Info
0x2631:016 (P400.16)	Function list: Activate keypad setpoint (Function list: Setp: Keypad) – For further possible settings, see parameter 0x2631:001 (P400.01). <b>0</b> Not connected	Assignment of a trigger for the "Activate keypad setpoint" function Trigger = TRUE: the keypad is used as setpoint source (if the trigger assigned has the highest setpoint priority). Trigger = FALSE: no action / deactivate function again. Notes: – The default keypad setpoint can be changed in keypad operation mode via the arrow keys of the keypad.

1585 GB 09 18

#### Keypad setpoint default setting

For the manual setpoint selection via keypad the following default settings are used:

- 0x2601:001 (P202.01): Keypad setpoints: Frequency setpoint
- 0x2601:002 (P202.02): Keypad setpoints: Process controller setpoint

The increment for keypad setpoints can be adapted in 0x2862 (P701.00) by pressing a keypad arrow key once.

#### Example for operating mode

- The analog input 1 is set as standard setpoint source.
- Switch S1 starts the motor in forward direction of rotation. Switch S1 in the initial position stops the motor again.
- Switch S2 switches the direction of rotation.
- Switch S3 activates the keypad as setpoint source. The keypad setpoint can be changed in the operating mode via the navigation keys ↑ and ↓ keypad keys.

Connection plan	Function
	Potentiometer R1
	Frequency setpoint selection
	Switch S1
	Run
Switch S2	Reverse rotational direction
Switch S3	Activate keypad setpoint

Parameter	Name	Setting for this example
0x2601:001 (P202.01)	Keypad setpoints: Frequency setpoint	20.0 Hz
0x2631:001 (P400.01)	Enable inverter	Constant TRUE [1]
0x2631:002 (P400.02)	Run	Digital input 1 [11]
0x2631:004 (P400.04)	Reset fault	Not connected [0]
0x2631:013 (P400.13)	Reverse rotational direction	Digital input 2 [12]
0x2631:016 (P400.16)	Activate keypad setpoint	Digital input 3 [13]
0x2824 (P200.00)	Control selection	Flexible I/O configuration [0]
0x2838:003 (P203.03)	Stop method	Standard ramp [1]
0x2860:001 (P201.01)	Frequency control: Default setpoint source	Analog input 1 [2]

### Input signals

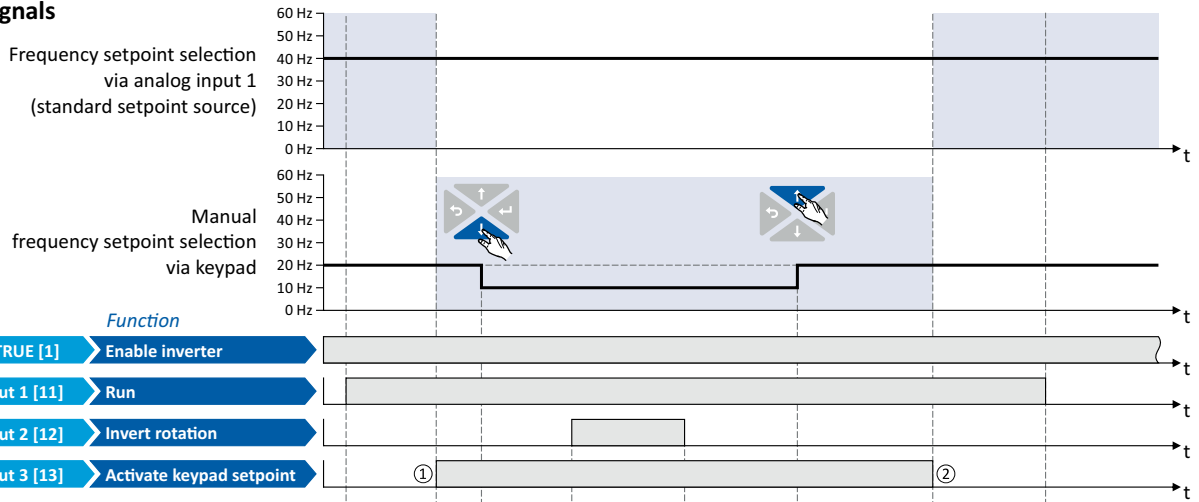

### Output signals

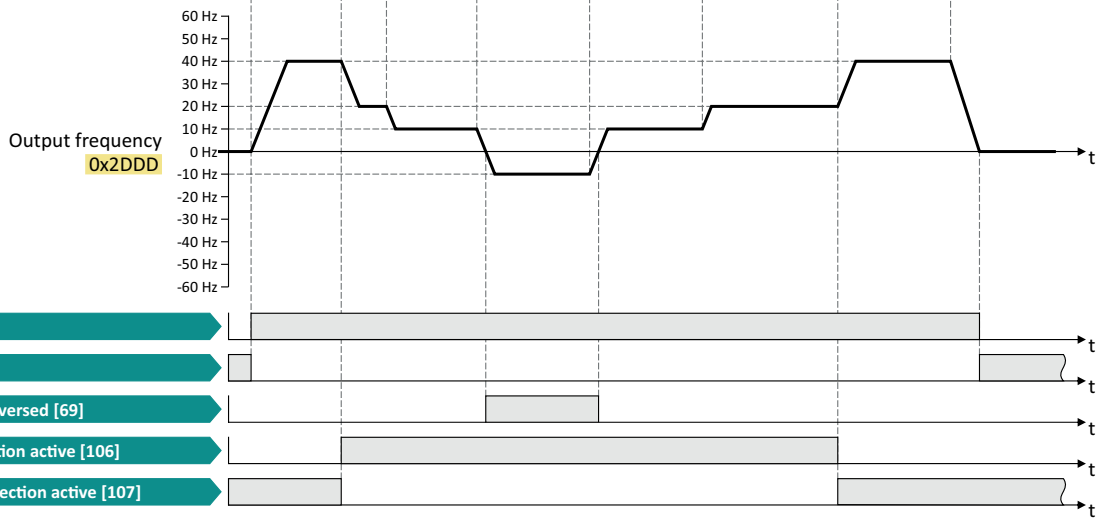

The status signals can be assigned to digital outputs. ▶ See chapter "Configuration of digital outputs".

- ① Change-over from analog input 1 (standard setpoint source) to keypad setpoint.
- ② Change-over from keypad setpoint back to analog input 1 (standard setpoint source).

### 12.3.5 SETPOINT SOURCE OF PRESET SETPOINTS

The four functions "Activate preset (bit 0)" ... "Activate preset (bit 3)" enable change-over of the setpoint to a parameterisable setpoint (preset value).

#### Preconditions

A setpoint change-over to the respective preset is only effected if no setpoint source with a higher priority has been selected. See chapter "Priority of the setpoint sources".

#### Details

A preset is selected in a binary-coded fashion via the triggers assigned to the four functions "Activate preset (bit 0)" ... "Activate preset (bit 3)" in compliance with the following truth table:

1585 GB 09 18

Activate preset				Selection			
Bit 3 0x2631:021 (P400.21)	Bit 2 0x2631:020 (P400.20)	Bit 1 0x2631:019 (P400.19)	Bit 0 0x2631:018 (P400.18)	Preset	Frequency setpoint	PID setpoint	Torque setpoint
FALSE	FALSE	FALSE	FALSE	No preset selected			
FALSE	FALSE	FALSE	TRUE	Preset 1	0x2911:001 (P450.01)	0x4022:001 (P451.01)	0x2912:001 (P452.01)
FALSE	FALSE	TRUE	FALSE	Preset 2	0x2911:002 (P450.02)	0x4022:002 (P451.02)	0x2912:002 (P452.02)
FALSE	FALSE	TRUE	TRUE	Preset 3	0x2911:003 (P450.03)	0x4022:003 (P451.03)	0x2912:003 (P452.03)
FALSE	TRUE	FALSE	FALSE	Preset 4	0x2911:004 (P450.04)	0x4022:004 (P451.04)	0x2912:004 (P452.04)
FALSE	TRUE	FALSE	TRUE	Preset 5	0x2911:005 (P450.05)	0x4022:005 (P451.05)	0x2912:005 (P452.05)
FALSE	TRUE	TRUE	FALSE	Preset 6	0x2911:006 (P450.06)	0x4022:006 (P451.06)	0x2912:006 (P452.06)
FALSE	TRUE	TRUE	TRUE	Preset 7	0x2911:007 (P450.07)	0x4022:007 (P451.07)	0x2912:007 (P452.07)
TRUE	FALSE	FALSE	FALSE	Preset 8	0x2911:008 (P450.08)	0x4022:008 (P451.08)	0x2912:008 (P452.08)
...				...	...		
TRUE	TRUE	TRUE	TRUE	Preset 15	0x2911:015 (P450.15)		

#### Notes:

- The frequency setpoint preset 5 is also used for the "Jog forward (CW)" 0x2631:010 (P400.10) function.
- The frequency setpoint preset 6 is also used for the "Jog reverse (CCW)" 0x2631:011 (P400.11) function.

Parameter	Name / value range / [default setting]	Info
0x2631:018 (P400.18)	Function list: Activate preset (bit 0) (Function list: Setp: Preset b0) – For further possible settings, see parameter 0x2631:001 (P400.01).	Assignment of a trigger for the "Activate preset (bit 0)" function. Selection bit with the valency 20 for the bit-coded selection and activation of a parameterised setpoint (preset value). Trigger = FALSE: selection bit = "0". Trigger = TRUE: selection bit = "1".
	<b>14</b> Digital input 4	
0x2631:019 (P400.19)	Function list: Activate preset (bit 1) (Function list: Setp: Preset b1) – For further possible settings, see parameter 0x2631:001 (P400.01).	Assignment of a trigger for the "Activate preset (bit 1)" function. Selection bit with the valency 21 for the bit-coded selection and activation of a parameterised setpoint (preset value). Trigger = FALSE: selection bit = "0". Trigger = TRUE: selection bit = "1".
	<b>15</b> Digital input 5	
0x2631:020 (P400.20)	Function list: Activate preset (bit 2) (Function list: Setp: Preset b2) – For further possible settings, see parameter 0x2631:001 (P400.01).	Assignment of a trigger for the "Activate preset (bit 2)" function. Selection bit with the valency 22 for the bit-coded selection and activation of a parameterised setpoint (preset value). Trigger = FALSE: selection bit = "0". Trigger = TRUE: selection bit = "1".
	<b>0</b> Not connected	
0x2631:021 (P400.21)	Function list: Activate preset (bit 3) (Function list: Setp: Preset b3) – For further possible settings, see parameter 0x2631:001 (P400.01).	Assignment of a trigger for the "Activate preset (bit 3)" function. Selection bit with the valency 23 for the bit-coded selection and activation of a parameterised setpoint (preset value). Trigger = FALSE: selection bit = "0". Trigger = TRUE: selection bit = "1".
	<b>0</b> Not connected	

Parameter	Name / value range / [default setting]	Info
0x2911:001 (P450.01)	Frequency setpoint presets: Preset 1 (Freq. presets: Freq. preset 1) 0.0 ... [20.0] ... 599.0 Hz	Parameterisable frequency setpoints (presets) for operating mode "MS: Velocity mode".
0x2911:002 (P450.02)	Frequency setpoint presets: Preset 2 (Freq. presets: Freq. preset 2) 0.0 ... [40.0] ... 599.0 Hz	
0x2911:003 (P450.03)	Frequency setpoint presets: Preset 3 (Freq. presets: Freq. preset 3) Device for 50-Hz mains: 0.0 ... [50.0] ... 599.0 Hz Device for 60-Hz mains: 0.0 ... [60.0] ... 599.0 Hz	
0x2911:004 (P450.04)	Frequency setpoint presets: Preset 4 (Freq. presets: Freq. preset 4) 0.0 ... [0.0] ... 599.0 Hz	
0x2911:005 (P450.05)	Frequency setpoint presets: Preset 5 (Freq. presets: Freq. preset 5) 0.0 ... [0.0] ... 599.0 Hz	
0x2911:006 (P450.06)	Frequency setpoint presets: Preset 6 (Freq. presets: Freq. preset 6) 0.0 ... [0.0] ... 599.0 Hz	
0x2911:007 (P450.07)	Frequency setpoint presets: Preset 7 (Freq. presets: Freq. preset 7) 0.0 ... [0.0] ... 599.0 Hz	
0x2911:008 (P450.08)	Frequency setpoint presets: Preset 8 (Freq. presets: Freq. preset 8) 0.0 ... [0.0] ... 599.0 Hz	
0x2911:009 (P450.09)	Frequency setpoint presets: Preset 9 (Freq. presets: Freq. preset 9) 0.0 ... [0.0] ... 599.0 Hz	
0x2911:010 (P450.10)	Frequency setpoint presets: Preset 10 (Freq. presets: Freq. preset 10) 0.0 ... [0.0] ... 599.0 Hz	
0x2911:011 (P450.11)	Frequency setpoint presets: Preset 11 (Freq. presets: Freq. preset 11) 0.0 ... [0.0] ... 599.0 Hz	
0x2911:012 (P450.12)	Frequency setpoint presets: Preset 12 (Freq. presets: Freq. preset 12) 0.0 ... [0.0] ... 599.0 Hz	
0x2911:013 (P450.13)	Frequency setpoint presets: Preset 13 (Freq. presets: Freq. preset 13) 0.0 ... [0.0] ... 599.0 Hz	
0x2911:014 (P450.14)	Frequency setpoint presets: Preset 14 (Freq. presets: Freq. preset 14) 0.0 ... [0.0] ... 599.0 Hz	
0x2911:015 (P450.15)	Frequency setpoint presets: Preset 15 (Freq. presets: Freq. preset 15) 0.0 ... [0.0] ... 599.0 Hz	

Parameter	Name / value range / [default setting]	Info
0x4022:001 (P451.01)	PID setpoint presets: Preset 1 (PID presets: PID preset 1) -300.00 ... [0.00] ... 300.00 PID unit	Parameterisable process controller setpoints (presets) for PID control.
0x4022:002 (P451.02)	PID setpoint presets: Preset 2 (PID presets: PID preset 2) -300.00 ... [0.00] ... 300.00 PID unit	
0x4022:003 (P451.03)	PID setpoint presets: Preset 3 (PID presets: PID preset 3) -300.00 ... [0.00] ... 300.00 PID unit	
0x4022:004 (P451.04)	PID setpoint presets: Preset 4 (PID presets: PID preset 4) -300.00 ... [0.00] ... 300.00 PID unit	
0x4022:005 (P451.05)	PID setpoint presets: Preset 5 (PID presets: PID preset 5) -300.00 ... [0.00] ... 300.00 PID unit	
0x4022:006 (P451.06)	PID setpoint presets: Preset 6 (PID presets: PID preset 6) -300.00 ... [0.00] ... 300.00 PID unit	
0x4022:007 (P451.07)	PID setpoint presets: Preset 7 (PID presets: PID preset 7) -300.00 ... [0.00] ... 300.00 PID unit	
0x4022:008 (P451.08)	PID setpoint presets: Preset 8 (PID presets: PID preset 8) -300.00 ... [0.00] ... 300.00 PID unit	

Example for operating mode

- The keypad is set as standard setpoint source.
- Switch S1 starts the motor in forward direction of rotation. Switch S1 in the initial position stops the motor again.
- The switches S2 ... S4 serve to switch over to the presets 1 ... 7 (see the following table).

Connection plan		Function				
		Switch S1		Run		
		Switch S2 ... S4		Preset selection		
		<b>S2</b>	<b>S3</b>	<b>S4</b>		
		Off	Off	Off	Keypad setpoint	
		On	Off	Off	Preset value 1	
		Off	On	Off	Preset value 2	
		On	On	Off	Preset value 3	
		Off	Off	On	Preset value 4	
		On	Off	On	Preset 5	
		Off	On	On	Preset 6	
On	On	On	Preset value 7			

Parameter	Name	Setting for this example
0x2631:001 (P400.01)	Enable inverter	Constant TRUE [1]
0x2631:002 (P400.02)	Run	Digital input 1 [11]
0x2631:004 (P400.04)	Reset fault	Not connected [0]
0x2631:013 (P400.13)	Reverse rotational direction	Not connected [0]
0x2631:018 (P400.18)	Activate preset (bit 0)	Digital input 2 [12]
0x2631:019 (P400.19)	Activate preset (bit 1)	Digital input 3 [13]
0x2631:020 (P400.20)	Activate preset (bit 2)	Digital input 4 [14]
0x2824 (P200.00)	Control selection	Flexible I/O configuration [0]
0x2838:003 (P203.03)	Stop method	Standard ramp [1]
0x2860:001 (P201.01)	Frequency control: Default setpoint source	Keypad [1]
0x2911:001 (P450.01)	Frequency setpoint presets: Preset 1	10 Hz
0x2911:002 (P450.02)	Frequency setpoint presets: Preset 2	15 Hz
0x2911:003 (P450.03)	Frequency setpoint presets: Preset 3	20 Hz
0x2911:004 (P450.04)	Frequency setpoint presets: Preset 4	25 Hz
0x2911:005 (P450.05)	Frequency setpoint presets: Preset 5	30 Hz
0x2911:006 (P450.06)	Frequency setpoint presets: Preset 6	35 Hz
0x2911:007 (P450.07)	Frequency setpoint presets: Preset 7	40 Hz

**i** If the frequency presets 8 ... 15 are required as well, the digital input 5 must be additionally assigned to the "Activate preset (bit 3)" function and the terminal DI5 must be interconnected accordingly.

**Input signals**

Frequency setpoint selection  
via keypad  
(standard setpoint source)

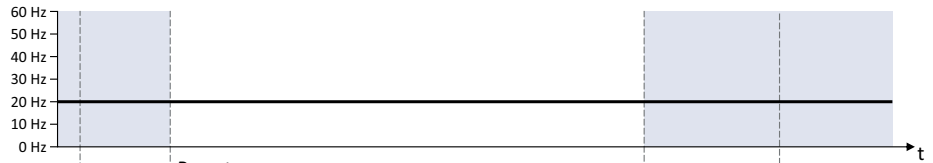

**Presets**

0x2911:1	0x2911:2	0x2911:3	0x2911:4	0x2911:5	0x2911:6	0x2911:7
10 Hz	15 Hz	20 Hz	25 Hz	30 Hz	35 Hz	40 Hz

*Trigger*

*Function*

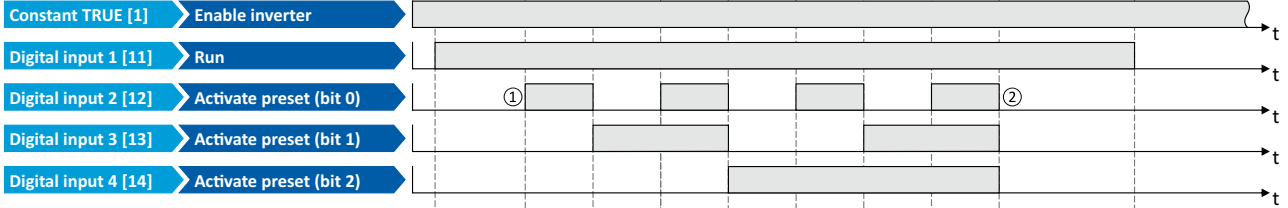

**Output signals**

Output frequency  
**0x2DDD**

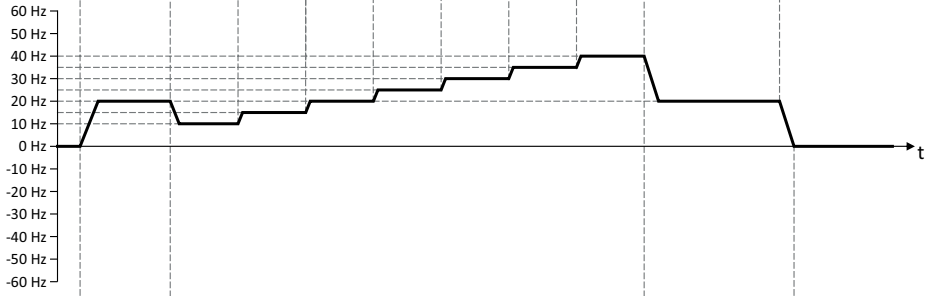

*Status signals*

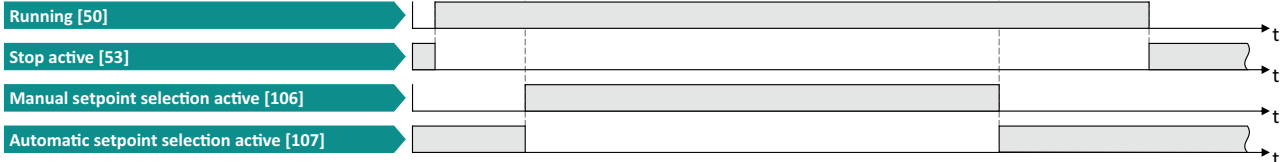

The status signals can be assigned to digital outputs. ▶ See chapter "Configuration of digital outputs".

- ① Change-over from keypad setpoint (standard setpoint source) to presets (first preset 1 is selected).
- ② Change-over back to keypad setpoint since no preset is selected anymore (digital inputs 2 ... 4 = FALSE).

### 12.3.6 MOTOR POTENTIOMETER SETPOINT SOURCE (MOP)

The "Motor potentiometer" function can be used as an alternative setpoint control that is controlled via two functions: "MOP setpoint up" and "MOP setpoint down".

– The "Activate MOP setpoint" function enables a setpoint change-over to the motor potentiometer.

– The motor potentiometer can also be defined as standard setpoint source.

► See chapter "Selection of setpoint source".

#### Preconditions

A setpoint change-over to the motor potentiometer is only effected if:

– no setpoint source with a higher priority has been selected.

► See chapter "Priority of the setpoint sources".

– no jog operation is active ("Jog forward (CW)" and "Jog reverse (CCW)" functions)

#### Details

If the motor potentiometer is active as setpoint source, the setpoint generated by this function ("MOP value") can be changed according to the truth table via the triggers assigned to the two "MOP setpoint up" and "MOP setpoint down" functions.

MOP setpoint up 0x2631:023 (P400.23)	MOP setpoint down 0x2631:024 (P400.24)	Response of the function
FALSE	FALSE	Last MOP value is maintained.
TRUE	FALSE	MOP value is increased to a maximum of the upper limit value for the respective operating mode with acceleration time 2. (The motor follows the setpoint change with acceleration time 1.)
FALSE	TRUE	MOP value is increased to a maximum of the lower limit value for the respective operating mode with deceleration time 2. (The motor follows the setpoint change with deceleration time 1.)
TRUE	TRUE	Last MOP value is maintained.

The starting performance can be selected in 0x4003 (P413.00). In the default setting, the last MOP value is used as initial value. The last MOP value is still available after switching off and on again the mains voltage. As an alternative, an adjustable initial value or the minimum value can be used for starting.

Parameter	Name / value range / [default setting]	Info
0x2631:023 (P400.23)	Function list: MOP setpoint up (Function list: MOP up) – For further possible settings, see parameter 0x2631:001 (P400.01).	Assignment of a trigger for the "MOP setpoint up" function. Trigger = TRUE: setpoint generated by the "Motor potentiometer" function ("MOP value") is maximally increased to the upper range limit with acceleration time 2. Trigger = FALSE: last MOP value is maintained.  Notes: – If the "MOP setpoint up" and "MOP setpoint down" functions are active at the same time the last MOP value is maintained. – Acceleration time 2 can be set in 0x2919 (P222.00).
	<b>0</b> Not connected	
0x2631:024 (P400.24)	Function list: MOP setpoint down (Function list: MOP down) – For further possible settings, see parameter 0x2631:001 (P400.01).	Assignment of a trigger for the "MOP setpoint down" function. Trigger = TRUE: setpoint generated by the "Motor potentiometer" function ("MOP value") is maximally decreased to the lower range limit with deceleration time 2. Trigger = FALSE: last MOP value is maintained  Notes: – If the "MOP setpoint up" and "MOP setpoint down" functions are active at the same time, the last MOP value is maintained. – Deceleration time 2 can be set in 0x291A (P223.00).
	<b>0</b> Not connected	
0x2631:025 (P400.25)	Function list: Activate MOP setpoint (Function list: Setp: MOP) – For further possible settings, see paramete 0x2631:001 (P400.01).	Assignment of a trigger for the "Activate MOP setpoint" function. Trigger = TRUE: the "Motor potentiometer" function is used as setpoint source (if the trigger assigned has the highest setpoint priority). Trigger = FALSE: no action / deactivate function again.
	<b>0</b> Not connected	

Parameter	Name / value range / [default setting]	Info
0x4003 (P413.00)	MOP starting mode (MOP startmode)	Selection of the initial value which is used after activation of the function.
	<b>0 Last value</b>	The last MOP value is used as initial value. It is still provided after the mains voltage has been switched off and on again.
	<b>1 Starting value</b>	The starting value of the corresponding operating mode is used as initial value: – 0x4004:001 (P414.01) for the operating mode "MS: Velocity mode" – 0x4004:002 (P414.02) for PID control – 0x4004:003 (P414.03) for the operating mode "MS: Torque mode"
	<b>2 Minimum value</b>	The minimum value of the corresponding operating mode is used as initial value: – 0x2915 (P210.00) for the operating mode "MS: Velocity mode" – 0x404E:001 (P605.01) for PID control
0x4004:001 (P414.01)	MOP starting values: Frequency (MOP start value: Frequency) 0.0 ... [0.0] ... 599.0 Hz	Starting value for operating mode "MS: Velocity mode". – This value is used as initial value if "Starting value [1]" is set in 0x4003 (P413.00).
0x4004:002 (P414.02)	MOP starting values: PID value (MOP start value: PID value) -300.00 ... [0.00] ... 300.00 PID unit	Starting value for reference value of the PID control. – This value is used as initial value if "Starting value [1]" is set in 0x4003 (P413.00).
0x4004:003 (P414.03)	MOP starting values: Torque (MOP start value: Torque) 0.0 ... [0.0] ... 1000.0 %	Starting value for operating mode "MS: Torque mode". – This value is used as initial value if "Starting value [1]" is set in 0x4003 (P413.00).
0x4009:001	MOP values saved: Frequency – Read only: x.x Hz	Display of the last MOP value saved internally for the operating mode "MS: Velocity mode". – This value is used as initial value if "Last value [0]" is set in 0x4003 (P413.00).
0x4009:002	MOP values saved: PID value – Read only: x.xx PID unit	Display of the last MOP value saved internally for the reference value of the PID control. – This value is used as initial value if "Last value [0]" is set in 0x4003 (P413.00).
0x4009:003	MOP values saved: Torque – Read only: x.x %	Display of the last MOP value saved internally for the operating mode "MS: Torque mode". – This value is used as initial value if "Last value [0]" is set in 0x4003 (P413.00).
0x2915 (P210.00)	Minimum frequency (Min. frequency) 0.0 ... [0.0] ... 599.0 Hz	Lower limit value for all frequency setpoints.
0x2916 (P211.00)	Maximum frequency (Max. frequency) Device for 50-Hz mains: 0.0 ... [50.0] ... 599.0 Hz Device for 60-Hz mains: 0.0 ... [60.0] ... 599.0 Hz	Upper limit value for all frequency setpoints.
0x2919 (P222.00)	Acceleration time 2 (Accelerat.time 2) 0.0 ... [5.0] ... 3600.0 s	Acceleration time 2 for the operating mode "MS: Velocity mode". – The acceleration time set refers to the acceleration from standstill to the maximum frequency set. In the case of a lower setpoint selection the actual acceleration time is reduced accordingly. – The acceleration time 2 is active if the frequency setpoint (absolute value) $\geq$ auto switching threshold 0x291B (P224.00) or the trigger assigned to the function "Activat ramp 2" in 0x2631:039 (P400.39) = TRUE. – The acceleration time 2 is also used for changing the MOP setpoint generated by the "motor potentiometer" function.
0x291A (P223.00)	Deceleration time 2 (Decelerat.time 2) 0.0 ... [5.0] ... 3600.0 s	Deceleration time 2 for the operating mode "MS: Velocity mode". – The deceleration time set refers to the deceleration from the maximum frequency set to standstill. In the case of a lower actual frequency, the actual deceleration time is reduced accordingly. – The deceleration time 2 is active if the frequency setpoint (absolute value) $\geq$ auto change-over threshold 0x291B (P224.00) or the trigger assigned to the function "Activate ramp 2" in 0x2631:039 (P400.39) = TRUE. – The deceleration time 2 is also used for changing the MOP setpoint generated by the "motor potentiometer" function.



Example for operating mode

- The analog input 1 is set as standard setpoint source.
- Switch S1 starts the motor in forward direction of rotation. Switch S1 in the initial position stops the motor again.
- Switch S2 activates the motor potentiometer as setpoint source. The MOP setpoint can then be increased via button S3 and reduced via button S4. If both buttons are pressed at the same time, the MOP setpoint remains unchanged.
- Switch S5 switches the direction of rotation.

Connection plan	Function	
	Potentiometer R1	
	Switch S1	Run
	Switch S2	Activate MOP setpoint
	Button S3	MOP setpoint up
	Button S4	MOP setpoint down
	Switch S5	Reverse rotational direction

Parameter	Name	Setting for this example
0x2631:001 (P400.01)	Enable inverter	Constant TRUE [1]
0x2631:002 (P400.02)	Run	Digital input 1 [11]
0x2631:025 (P400.25)	Activate MOP setpoint	Digital input 2 [12]
0x2631:023 (P400.23)	MOP setpoint up	Digital input 3 [13]
0x2631:024 (P400.24)	MOP setpoint down	Digital input 4 [14]
0x2631:013 (P400.13)	Reverse rotational direction	Digital input 5 [15]
0x2824 (P200.00)	Control selection	Flexible I/O configuration [0]
0x2838:003 (P203.03)	Stop method	Standard ramp [1]
0x2860:001 (P201.01)	Frequency control: Default setpoint source	Analog input 1 [2]
0x2917 (P220.00)	Acceleration time 1	1.0 s
0x2918 (P221.00)	Deceleration time 1	1.0 s
0x2919 (P222.00)	Acceleration time 2	4.0 s (for MOP setpoint change)
0x291A (P223.00)	Deceleration time 2	4.0 s (for MOP setpoint change)
0x4003 (P413.00)	MOP starting mode	Starting value [1]
0x4004:001 (P414.01)	MOP starting values: Frequency	20 Hz

Input signals

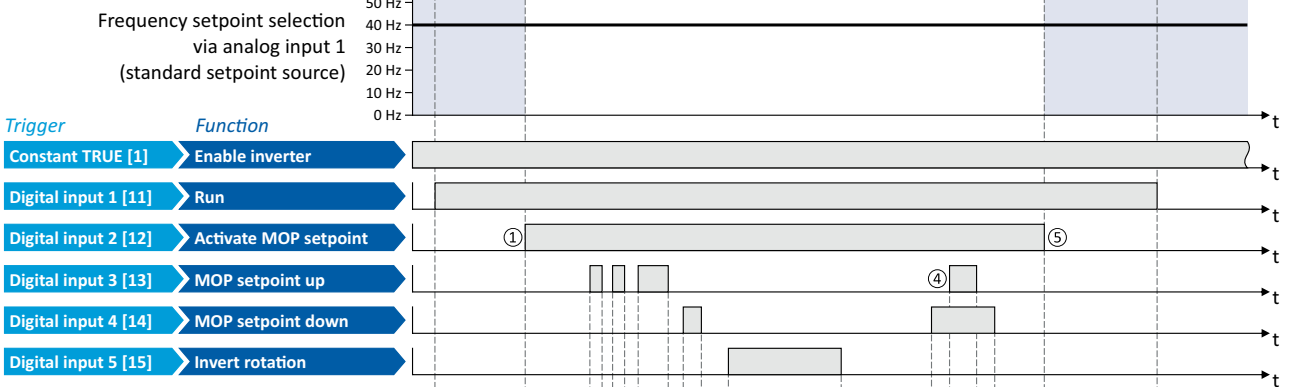

Output signals

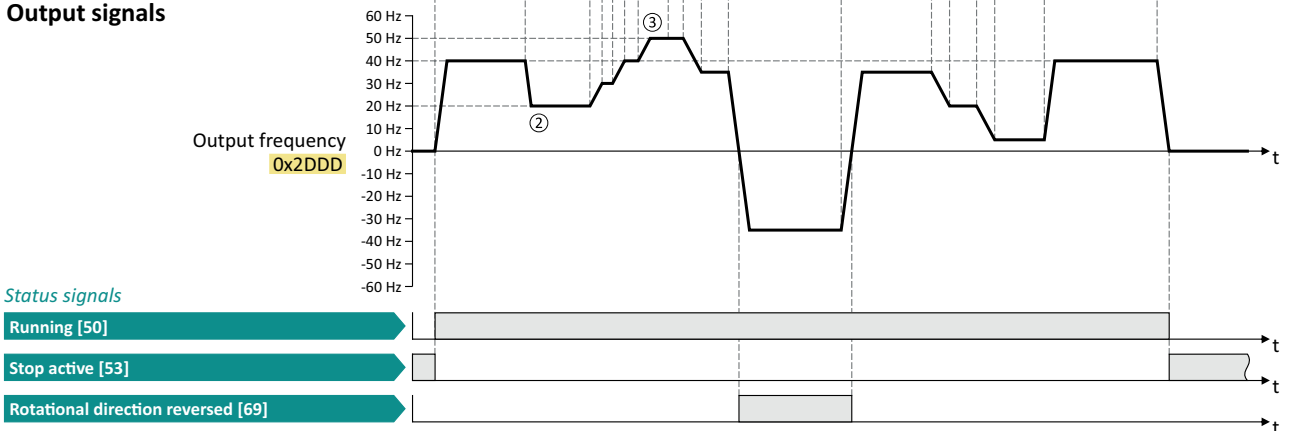

The status signals can be assigned to digital outputs. ▶ See chapter "Configuration of digital outputs".

- ① Change-over from analog input 1 (standard setpoint source) to MOP setpoint.
- ② The initial value for the motor potentiometer function depends on the setting in 0x4003 (P413.00). In this example, the 'starting value' set in 0x4004:001 (P414.01) is used (here: 20 Hz).
- ③ The MOP setpoint is maximally increased to the maximum frequency set in 0x2916 (P211.00) (here: 50 Hz).
- ④ If "MOP setpoint up" and "MOP setpoint down" are requested at the same time, the MOP setpoint remains unchanged.
- ⑤ Change-over from MOP setpoint back to analog input 1 (standard setpoint source).

### 12.3.7 SETPOINT SOURCE SEGMENT SETPOINTS

The four functions "Activate segment setpoint (bit 0) ... " Activate segment setpoint (bit 3)" enable a setpoint change-over to a segment setpoint parameterised for the "sequencer" function during normal operation.

#### Preconditions

A setpoint change-over to the respective segment setpoint is only effected if no setpoint source with a higher priority has been selected. See chapter "Priority of the setpoint sources".

#### Details

A segment setpoint is selected in a binary-coded fashion via the triggers assigned to the four function "Activate segment setpoint (bit 0) ... " Activate segment setpoint (bit 3)" in compliance with the following truth table:

1585 GB 09 18

Activate segment setpoint				Selection			
Bit 3 0x2631:029 (P400.29)	Bit 2 0x2631:028 (P400.28)	Bit 1 0x2631:027 (P400.27)	Bit 0 0x2631:026 (P400.26)	Preset	Frequency setpoint	PID setpoint	Torque setpoint
FALSE	FALSE	FALSE	FALSE	No segment setpoint selected			
FALSE	FALSE	FALSE	TRUE	1	0x4026:001 (P801.01)	0x4026:006 (P801.06)	0x4026:007 (P801.07)
FALSE	FALSE	TRUE	FALSE	2	0x4027:001 (P802.01)	0x4027:006 (P802.06)	0x4027:007 (P802.07)
FALSE	FALSE	TRUE	TRUE	3	0x4028:001 (P803.01)	0x4028:006 (P803.06)	0x4028:007 (P803.07)
FALSE	TRUE	FALSE	FALSE	4	0x4029:001 (P804.01)	0x4029:006 (P804.06)	0x4029:007 (P804.07)
FALSE	TRUE	FALSE	TRUE	5	0x402A:001 (P805.01)	0x402A:006 (P805.06)	0x402A:007 (P805.07)
FALSE	TRUE	TRUE	FALSE	6	0x402B:001 (P806.01)	0x402B:006 (P806.06)	0x402B:007 (P806.07)
FALSE	TRUE	TRUE	TRUE	7	0x402C:001 (P807.01)	0x402C:006 (P807.06)	0x402C:007 (P807.07)
TRUE	FALSE	FALSE	FALSE	8	0x402D:001 (P808.01)	0x402D:006 (P808.06)	0x402D:007 (P808.07)
TRUE	FALSE	FALSE	TRUE	Invalid selection			
...							
TRUE	TRUE	TRUE	TRUE				

Parameter	Name / value range / [default setting]	Info
0x2631:026 (P400.26)	Function list: Activate segment setpoint (bit 0) (Function list: Setp: Segment b0)  – For further possible settings, see parameter 0x2631:001 (P400.01).	Assignment of a trigger for the "Activate segment setpoint (bit 0)" function. Selection bit with the valency 20 for the bit-coded selection and activation of a parameterised segment setpoint. Trigger = FALSE: selection bit = "0". Trigger = TRUE: selection bit = "1".
	<b>0</b> Not connected	Notes: – During normal operation (no active sequence), this function serves to activate the setpoint of a segment (instead of an entire sequence in the sequencer operation). – This function is not intended for the use in the sequencer operation.
0x2631:027 (P400.27)	Function list: Activate segment setpoint (bit 1) (Function list: Setp: Segment b1)  – For further possible settings, see parameter 0x2631:001 (P400.01).	Assignment of a trigger for the "Activate segment setpoint (bit 1)" function. Selection bit with the valency 21 for the bit-coded selection and activation of a parameterised segment setpoint. Trigger = FALSE: selection bit = "0". Trigger = TRUE: selection bit = "1".
	<b>0</b> Not connected	Notes: – During normal operation (no active sequence), this function serves to activate the setpoint of a segment (instead of an entire sequence in the sequencer operation). – This function is not intended for the use in the sequencer operation.
0x2631:028 (P400.28)	Function list: Activate segment setpoint (bit 2) (Function list: Setp: Segment b2)  – For further possible settings, see parameter 0x2631:001 (P400.01).	Assignment of a trigger for the "Activate segment setpoint (bit 2)" function. Selection bit with the valency 22 for the bit coded selection and activation of a parameterised segment setpoint. Trigger = FALSE: selection bit = "0". Trigger = TRUE: selection bit = "1".
	<b>0</b> Not connected	Notes: – During normal operation (no active sequence), this function serves to activate the setpoint of a segment (instead of an entire sequence in the sequencer operation). – This function is not intended for the use in the sequencer operation.
0x2631:029 (P400.29)	Function list: Activate segment setpoint (bit 3) (Function list: Setp: Segment b3)  – For further possible settings, see parameter 0x2631:001 (P400.01).	Assignment of a trigger for the "Activate segment setpoint (bit 3)" function. Selection bit with the valency 23 for the bit coded selection and activation of a parameterised segment setpoint. Trigger = FALSE: selection bit = "0". Trigger = TRUE: selection bit = "1".
	<b>0</b> Not connected	Notes: – During normal operation (no active sequence), this function serves to activate the setpoint of a segment (instead of an entire sequence in the sequencer operation). – This function is not intended for the use in the sequencer operation.

## 12.4 RESET ERROR

By means of the "Reset fault" function, an active error can be reset (acknowledged).

### Preconditions

The error can only be reset if the error cause has been eliminated.

Parameter	Name / value range / [default setting]	Info
0x2631:004 (P400.04)	Function list: Reset fault (Function list: Reset fault) – For further possible settings, see parameter 0x2631:001 (P400.01).	Assignment of a trigger for the "Reset fault" function. Trigger = FALSE→TRUE (edge): Active error is reset (acknowledged) if the error condition is not active anymore and the error is resettable. Trigger = FALSE: no action
	<b>12</b> Digital input 2	
0x2839:006	Fault configuration: Fault handling in case of state change	Selection whether a pending error is to be reset via the function "Enable inverter" 0x2631:001 (P400.01) and "Run" 0x2631:002 (P400.02) as well.
	<b>0</b> Reset fault	
	1 Do not reset fault	

1585 GB 09 18

### Further options for resetting an error

In addition to the "Reset error" function, there are the following options to reset an error:

Function	Required state change to reset an error:
Enable inverter 0x2631:001 (P400.01)	TRUE→FALSE (edge)
Run 0x2631:002 (P400.02)	TRUE→FALSE (edge); see the following example
Keypad key 	Keystroke

### Example for operating mode

- Switch S1 starts the motor in forward direction of rotation. Switch S1 in the initial position stops the motor again.
- Switch S2 resets the current error if the error condition is not active anymore and the error is resettable.
- The switches/sensors S3 and S4 serve to set the variable speed drives from the process to the error status.
  - ▶ See chapter "triggering a user-defined fault".

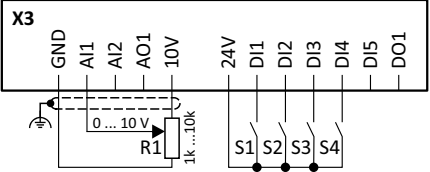
Connection plan	Function	
	Potentiometer R1	
	Frequency setpoint selection	
	Switch S1	Run
	Switch S2	Reset fault
	Switch S3	Activate falt 1
Switch S4	Activate falt 2	

Parameter	Name	Setting for this example
0x2631:001 (P400.01)	Enable inverter	Constant TRUE [1]
0x2631:002 (P400.02)	Run	Digital input 1 [11]
0x2631:004 (P400.04)	Reset fault	Digital input 2 [12]
0x2631:013 (P400.13)	Reverse rotational direction	Not connected [0]
0x2631:018 (P400.18)	Activate preset (bit 0)	Not connected [0]
0x2631:043 (P400.43)	Activate fault 1	Digital input 3 [13]
0x2631:044 (P400.44)	Activate fault 2	Digital input 4 [14]
0x2824 (P200.00)	Control selection	Flexible I/O configuration [0]
0x2838:003 (P203.03)	Stop method	Standard ramp [1]
0x2860:001 (P201.01)	Frequency control: Default setpoint source	Analog input 1 [2]
0x2918 (P221.00)	Deceleration time 1	5.0 s
0x291C (P225.00)	Quick stop deceleration time	1.0 s

The following signal flow illustrates the reset of an error both with the "Reset error" function ② and by cancelling the start command ④:

1585 GB 09 18

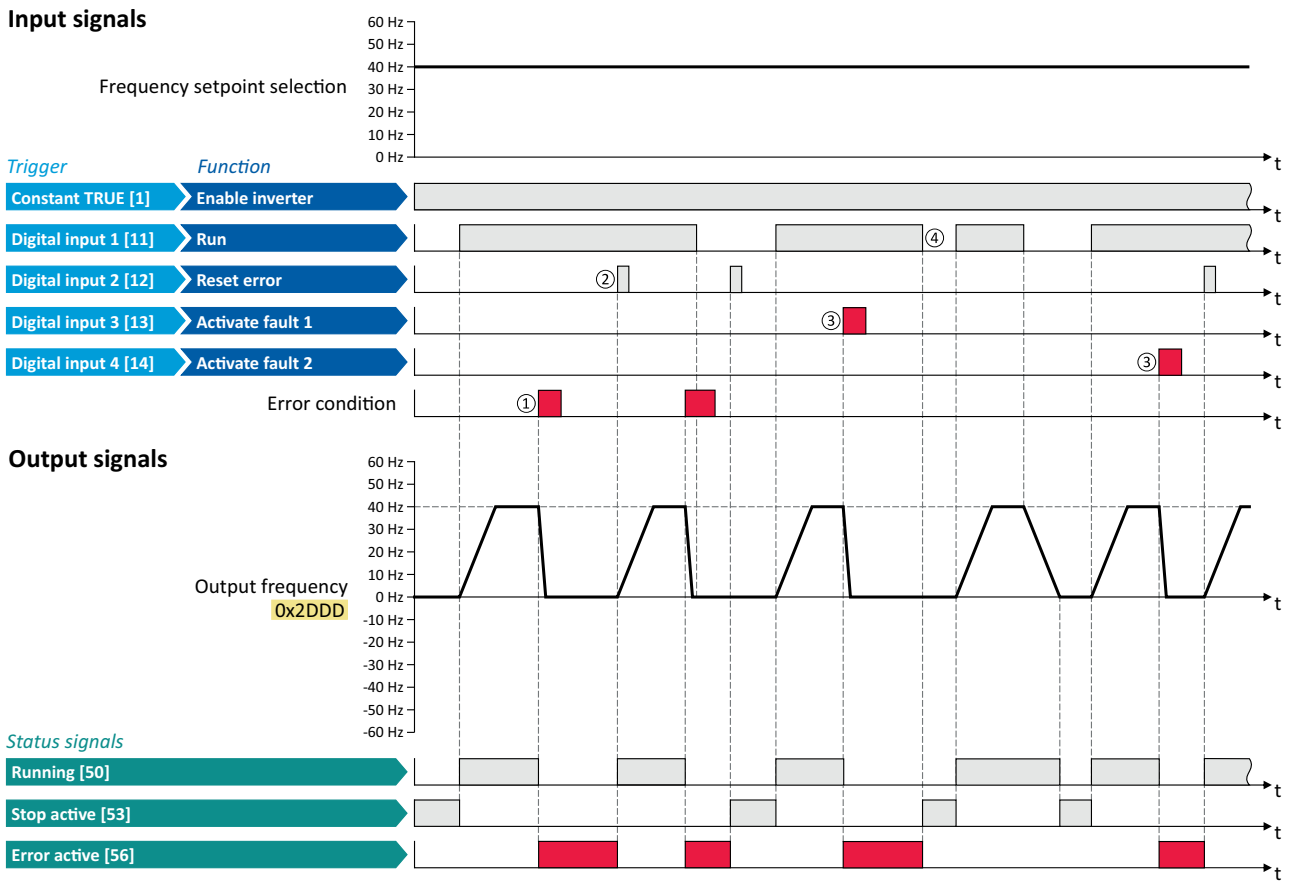

The status signals can be assigned to digital outputs. ► See chapter "Configuration of digital outputs".

- ① If an error condition is active in the variable speed drive, the motor is brought to a standstill with the quick stop ramp. The variable speed drive is then disabled.  
Exception: In case of a serious error, the variable speed drive is disabled immediately. The motor becomes torqueless (coasts).
- ② If the error can be reset, the error state can be left again with the "Reset fault" function (if the error condition no longer exists).  
The motor accelerates again to the setpoint since the start command is still active.
- ③ The functions "Activate fault 1" and "Activate fault 2" serve to set the variable speed drive from the process to the error status.
- ④ If the error can be reset, the cancelled start command results in leaving the error state (if the error condition no longer exists).

## 12.5 ACTIVATING DC BRAKING MANUALLY

By means of the "Activate DC braking" function, DC braking can be activated manually.

### Preconditions

The current for DC braking must be set > 0 % so that the function can be executed.

Parameter	Name / value range / [default setting]	Info
0x2631:005 (P400.05)	Function list: Activate DC braking (Function list: DC braking) – For further possible settings, see parameter 0x2631:001 (P400.01).	Assignment of a trigger for the "Activate DC braking" function. Trigger = TRUE: Activate DC braking. Trigger = FALSE: Deactivate DC braking. <b>CAUTION!</b> DC braking remains active as long as the trigger is set to TRUE. ► See chapter "DC braking".
	<b>0</b> Not connected	
0x2B84:001 (P704.01)	DC braking: Current (DC braking: Current) 0.0 ... [0.0] ... 200.0 %	Braking current for DC braking. – 100 % = rated motor current 0x6075 (P323.00)

### Example for operating mode

- Switch S1 starts the motor in forward direction of rotation. Switch S1 in the initial position stops the motor again.
- Switch S2 activates DC braking.

Connection plan	Function
	Potentiometer R1
	Switch S1
	Switch S2
	Frequency setpoint selection
	Run
	Activate DC braking

Parameter	Name	Setting for this example
0x2631:001 (P400.01)	Enable inverter	Constant TRUE [1]
0x2631:002 (P400.02)	Run	Digital input 1 [11]
0x2631:004 (P400.04)	Reset fault	Not connected [0]
0x2631:005 (P400.05)	Activate DC braking	Digital input 2 [12]
0x2824 (P200.00)	Control selection	Flexible I/O configuration [0]
0x2838:003 (P203.03)	Stop method	Standard ramp [1]
0x2860:001 (P201.01)	Frequency control: Default setpoint source	Analog input 1 [2]
0x2B84:001 (P704.01)	DC braking: Current	10 %

### Input signals

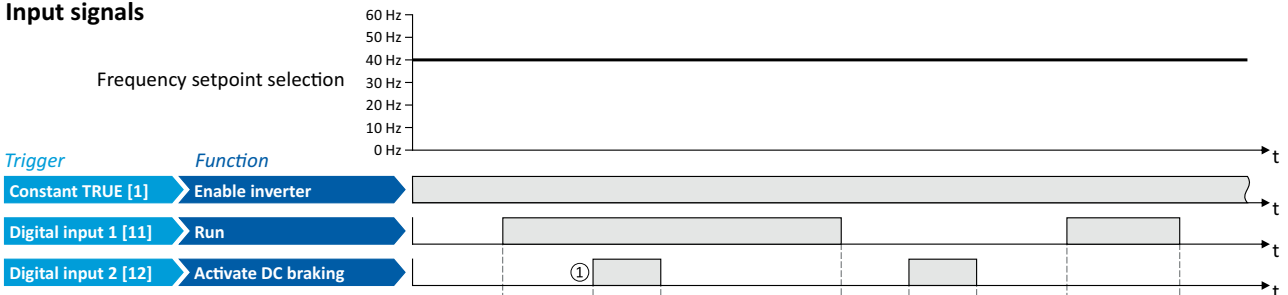

### Output signals

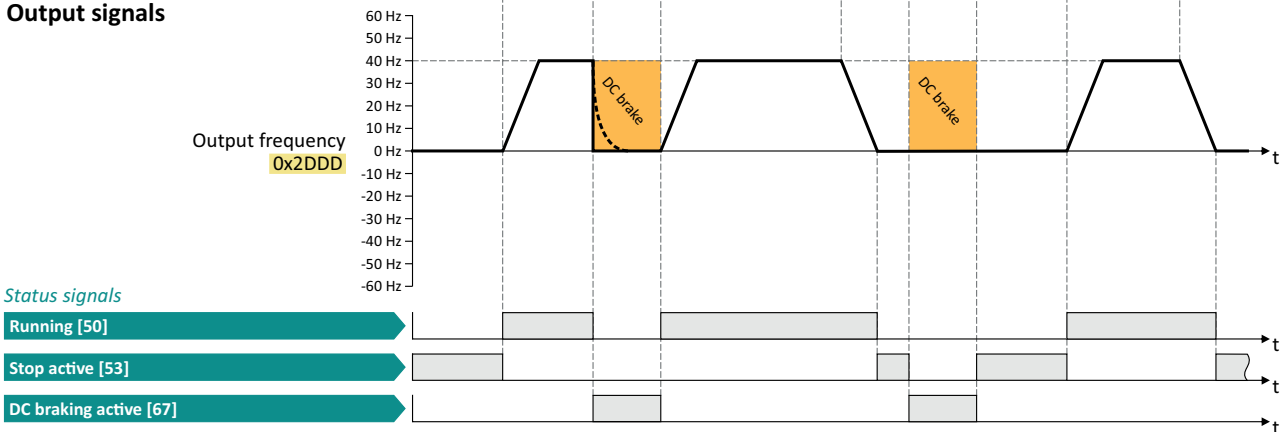

The status signals can be assigned to digital outputs. ► See chapter "Configuration of digital outputs".

① If DC braking is activated while the motor is running, the output pulses of the variable speed drive are disabled immediately.

For stopping the motor, the current set in 0x2B84:001 (P704.01) is injected. The exact drive behaviour depends on the setting for the "DC braking" function and the load properties.

## 12.6 RELEASING HOLDING BRAKE MANUALLY

The "Release holding brake" function serves to release the holding brake immediately. Brake application time and brake opening time as well as the conditions for the automatic operation are not effective.

### Preconditions

- Observe setting and application notes in the "Holding brake control" chapter!
- The brake mode "Automatic [0]" or "Manual [1]" must be set in 0x2820:001 (P712.01).
- The "Release holding brake [115]" trigger has to be assigned to a digital output or, in the simplest case, to the relay which then switches the brake supply.

### Details

Detailed information about the function and configuration of the holding brake control can be found in the "Holding brake control" chapter.

1585 GB 09 18

Parameter	Name / value range / [default setting]	Info
0x2631:049 (P400.49)	Function list: Release holding brake (Function list: Release brake) – Setting can only be changed if the variable speed drive is inhibited. – For further possible settings, see parameter 0x2631:001 (P400.01).	Assignment of a trigger for the "Release holding brake" function. Trigger = TRUE: Release holding brake (immediately). Trigger = FALSE: no action.  Notes: – Function is only executed if the brake mode 0x2820:001 (P712.01) is set to "Automatic [0]" or "Manual [1]". <b>CAUTION!</b> – The manually triggered "Release holding brake" command has a direct impact on the "Release holding brake [115]" trigger. Thus, the holding brake can be manually released if the power section is switched off.
	<b>0 Not connected</b>	

### Example for operating mode

- Switch S1 starts the motor in forward direction of rotation. Switch S1 in the initial position stops the motor again.
- Switch S2 releases the holding brake. For this purpose, in this example, trigger "Release holding brake [115]" is assigned to the relay that switches the brake supply.

Connection plan	Function	
	Potentiometer R1	Frequency setpoint selection
	Switch S1	Run
	Switch S2	Release holding brake

Parameter	Name	Setting for this example
0x2631:001 (P400.01)	Enable inverter	Constant TRUE [1]
0x2631:002 (P400.02)	Run	Digital input 1 [11]
0x2631:004 (P400.04)	Reset fault	Not connected [0]
0x2631:049 (P400.49)	Release holding brake	Digital input 2 [12]
0x2634:001 (P420.01)	Relay	Release holding brake [115]
0x2824 (P200.00)	Control selection	Flexible I/O configuration [0]
0x2838:003 (P203.03)	Stop method	Standard ramp [1]
0x2860:001 (P201.01)	Frequency control: Default setpoint source	Analog input 1 [2]

### Input signals

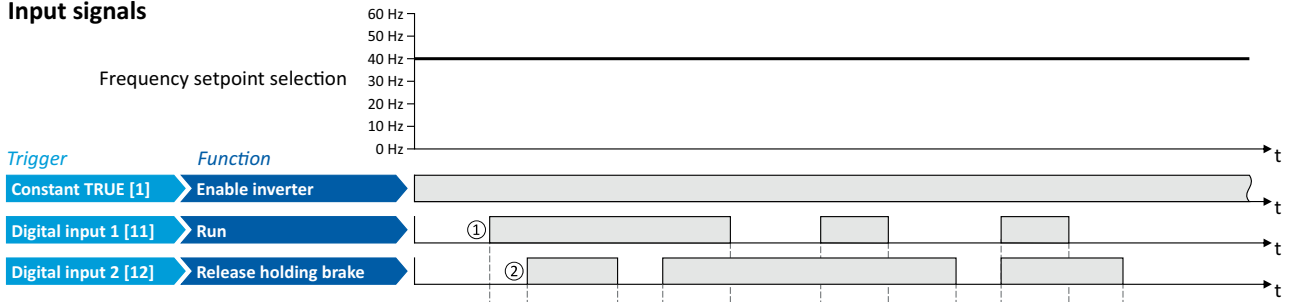

### Output signals

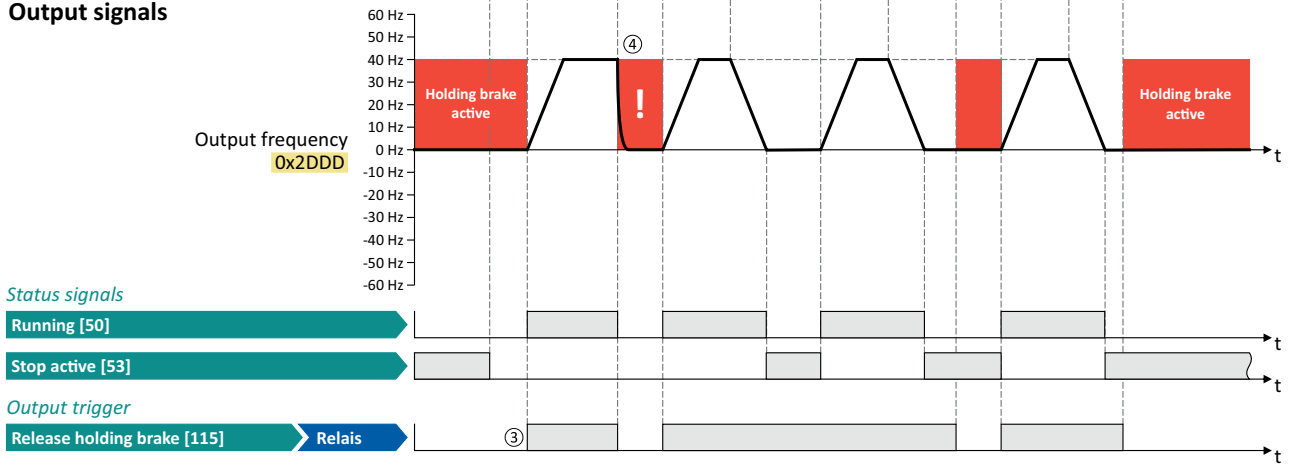

The status signals can be assigned to digital outputs. ▶ See chapter "Configuration of digital outputs".

- ① As the holding brake is active, the motor does not yet start to rotate after the start command.
- ② The holding brake is released. The motor is led to the setpoint.
- ③ In this example, the "Release holding brake [115]" trigger is assigned to the relay that switches the brake supply. In idle state, the holding brake is applied. If the relay is energised, the holding brake is released.
- ④ Note: Holding brakes are not intended for braking during operation. The increased wear caused by braking during operation may destroy the holding brakes prematurely!

## 12.7 ACTIVATING RAMP 2 MANUALLY

The "Activate ramp 2" function serves to manually activate acceleration time 2 and deceleration time 2.

Parameter	Name / value range / [default setting]	Info
0x2631:039 (P400.39)	Function list: Activat ramp 2 (Function list: Activ ramp 2) – For further possible settings, see parameter 0x2631:001 (P400.01).	Assignment of a trigger for the "Activate ramp 2" function. Trigger = TRUE: activate acceleration time 2 and deceleration time 2 manually. Trigger = FALSE: no action / deactivate function again.
	<b>0 Not connected</b>	Notes: – If the function is used and the assigned trigger = TRUE, the auto change-over threshold 0x291B (P224.00) for ramp 2 is deactivated. – Acceleration time 2 can be set in 0x2919 (P222.00). – Deceleration time 2 can be set in 0x291A (P223.00).
0x2917 (P220.00)	Acceleration time 1 (Accelerat.time 1) 0.0 ... [5.0] ... 3600.0 s	Acceleration time 1 for the operating mode "MS: Velocity mode". – The acceleration time set refers to the acceleration from standstill to the maximum frequency set. In the case of a lower setpoint selection the actual acceleration time is reduced accordingly.
0x2918 (P221.00)	Deceleration time 1 (Decelerat.time 1) 0.0 ... [5.0] ... 3600.0 s	Deceleration time 1 for the operating mode "MS: Velocity mode". – The deceleration time set refers to the deceleration from the maximum frequency set to standstill. In the case of a lower actual frequency, the actual deceleration time is reduced accordingly.
0x2919 (P222.00)	Acceleration time 2 (Accelerat.time 2) 0.0 ... [5.0] ... 3600.0 s	Acceleration time 2 for the operating mode "MS: Velocity mode". – The acceleration time set refers to the acceleration from standstill to the maximum frequency set. In the case of a lower setpoint selection the actual acceleration time is reduced accordingly. – The acceleration time 2 is active if the frequency setpoint (absolute value) $\geq$ auto switching threshold 0x291B (P224.00) or the trigger assigned to the function "Activat ramp 2" in 0x2631:039 (P400.39) = TRUE. – The acceleration time 2 is also used for changing the MOP setpoint generated by the "motor potentiometer" function.
0x291A (P223.00)	Deceleration time 2 (Decelerat.time 2) 0.0 ... [5.0] ... 3600.0 s	Deceleration time 2 for the operating mode "MS: Velocity mode". – The deceleration time set refers to the deceleration from the maximum frequency set to standstill. In the case of a lower actual frequency, the actual deceleration time is reduced accordingly. – The deceleration time 2 is active if the frequency setpoint (absolute value) $\geq$ auto change-over threshold 0x291B (P224.00) or the trigger assigned to the function "Activat ramp 2" in 0x2631:039 (P400.39) = TRUE. – The deceleration time 2 is also used for changing the MOP setpoint generated by the "motor potentiometer" function.



Example for operating mode

- Switch S1 starts the motor in forward direction of rotation. Switch S1 in the initial position stops the motor again.
- Switch S2 activates the acceleration time 2 and deceleration time 2.

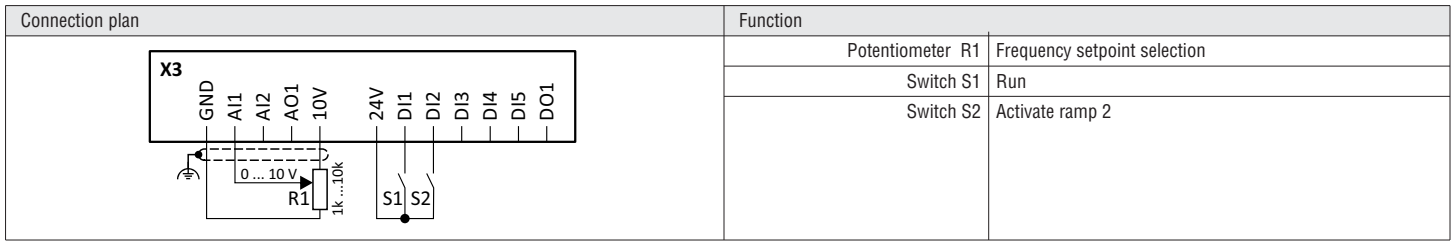

1585 GB 09 18

Parameter	Name	Setting for this example
0x2631:001 (P400.01)	Enable inverter	Constant TRUE [1]
0x2631:002 (P400.02)	Run	Digital input 1 [11]
0x2631:004 (P400.04)	Reset fault	Not connected [0]
0x2631:039 (P400.39)	Activate ramp 2	Digital input 2 [12]
0x2824 (P200.00)	Control selection	Flexible I/O configuration [0]
0x2838:003 (P203.03)	Stop method	Standard ramp [1]
0x2860:001 (P201.01)	Frequency control: Default setpoint source	Analog input 1 [2]
0x2917 (P220.00)	Acceleration time 1	10.0 s
0x2918 (P221.00)	Deceleration time 1	10.0 s
0x2919 (P222.00)	Acceleration time 2	5.0 s
0x291A (P223.00)	Deceleration time 2	5.0 s

### Input signals

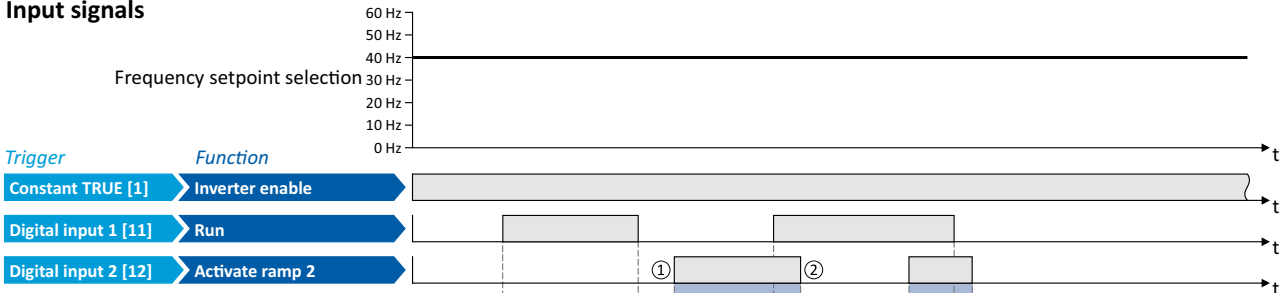

### Output signals

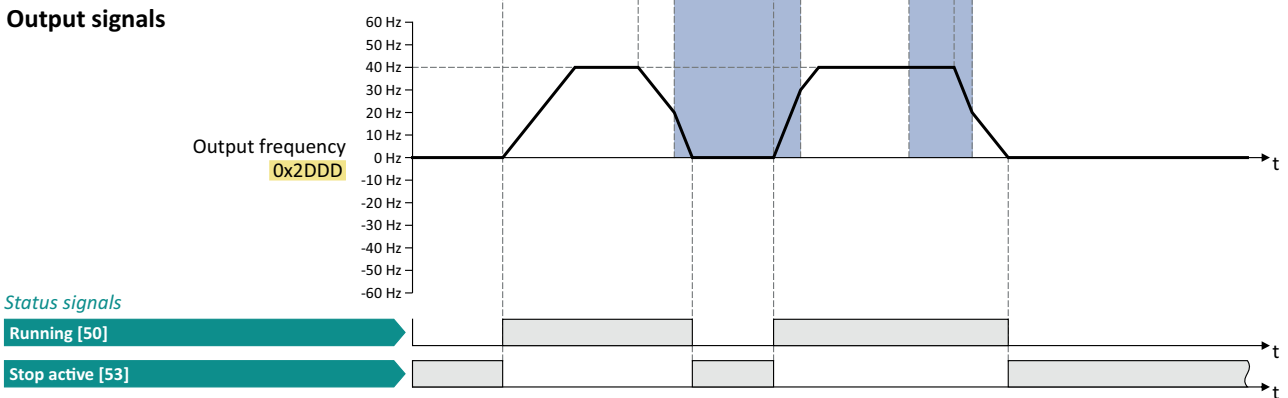

The status signals can be assigned to digital outputs. ▶ See chapter "Configuration of digital outputs".

- ① Change-over to deceleration time 2 during the deceleration phase.
- ② Change-over to acceleration time 1 during the acceleration phase.

## 12.9 FUNCTION FOR PARAMETER CHANGE-OVER

The variable speed drive supports several parameter sets. The parameter set can be selected by means of the "Select parameter set (bit 0)" and "Select parameter set (bit 1)" functions.

### DANGER!

Changed parameter setting can become effective immediately depending on the activation method set in 0x4046 (P755.00).

The possible consequence is an unexpected response of the motor shaft while the variable speed drive is enabled.

- ▶ If possible, only carry out parameter changes while the variable speed drive is disabled.
- ▶ Certain device commands or settings which might cause a critical state of the drive behaviour are generally only carried out when the variable speed drive is inhibited.

#### Details

The "parameter change-over" function provides a change-over between four sets with different parameter values for up to 32 freely selectable parameters. For details on the compilation of the parameters and setting of the value sets, see the chapter "Parameter change-over".

A value set is selected in a binary-coded fashion via the triggers assigned to the two "Select parameter set (bit 0)" and "Select parameter set (bit 1)" functions in compliance with the following truth table:

Select parameter set (bit 1) 0x2631:042 (P400.42)	Select parameter set (bit 0) 0x2631:041 (P400.41)	Selection
FALSE	FALSE	Value set 1
FALSE	TRUE	Value set 2
TRUE	FALSE	Value set 3
TRUE	TRUE	Value set 4

Change-over is effected depending on the activation method selected in 0x4046 (P755.00) when a state change of the selection inputs takes place or via the trigger assigned to the "Load parameter set" function.

Parameter	Name / value range / [default setting]	Info
0x2631:040 (P400.40)	Function list: Load parameter set (Function list: Load param.set) – Setting can only be changed if the variable speed drive is inhibited. – For further possible settings, see parameter 0x2631:001 (P400.01).	Assignment of a trigger for the "Load parameter set" function. Trigger = FALSE-TRUE edge: parameter change-over to the value set selected via "Select parameter set (bit 0)" and "Select parameter set (bit 1)". Trigger = FALSE: no action. Notes: – The activation method for the "Parameter change-over" function can be selected in 0x4046 (P755.00).
	<b>0</b> Not connected	
0x2631:041 (P400.41)	Function list: Select parameter set (bit 0) (Function list: Sel. paramset b0) – Setting can only be changed if the variable speed drive is inhibited. – For further possible settings, see parameter 0x2631:001 (P400.01).	Assignment of a trigger for the "Select parameter set (bit 0)" function. Selection bit with the valency 20 for "Parameter change-over" function. Trigger = FALSE: selection bit = "0". Trigger = TRUE: selection bit = "1".
	<b>0</b> Not connected	
0x2631:042 (P400.42)	Function list: Select parameter set (bit 1) (Function list: Sel. paramset b1) – Setting can only be changed if the variable speed drive is inhibited. – For further possible settings, see parameter 0x2631:001 (P400.01).	Assignment of a trigger for the "Select parameter set (bit 1)" function. Selection bit with the valency 21 for "Parameter change-over" function. Trigger = FALSE: selection bit = "0". Trigger = TRUE: selection bit = "1".
	<b>0</b> Not connected	

Parameter	Name / value range / [default setting]	Info
0x4046 (P755.00)	Activation of parameter set (PSet activation)	Selection of the activation method for the parameter change-over. – If the selection is changed from "Via command... [0]/[1]" to "If the selection is changed...[2]/[3]" after switch-on, the parameter set selected via the functions "Select parameter set (bit 0)" and "Select parameter set (bit 1)" is activated immediately. In case of selection [2], however, this only takes place if the variable speed drive is disabled, the motor is stopped or an error is active.
	<b>0</b> Via command (disable required)	The parameter set selected via the functions "Select parameter set (bit 0)" and "Select parameter set (bit 1)" is activated if the trigger assigned to the "Load parameter set" function in 0x2631:040 (P400.40) provides a FALSE-TRUE edge AND the variable speed drive is inhibited, the motor is stopped or an error is active.
	1 Via command (immediately)	The parameter set selected via the functions "Select parameter set (bit 0)" and "Select parameter set (bit 1)" is immediately activated if the trigger assigned to the "Load parameter set" function in 0x2631:040 (P400.40) provides a FALSE-TRUE edge.
	2 If the selection is changed (disable required)	The parameter set selected via the functions "Select parameter set (bit 0)" and "Select parameter set (bit 1)" is activated if the state of these selection bits changes AND the variable speed drive is inhibited, the motor is stopped or an error is active.
	3 If the selection is changed (immediately)	The parameter set selected via the functions "Select parameter set (bit 0)" and "Select parameter set (bit 1)" is activated immediately if the state of these selection bits is changed.

12.9.1 EXAMPLE 1: ACTIVATION VIA COMMAND (ONLY WHEN DISABLED)

Activation method 0x4046 (P755.00) = "Via command (disable required) [0]":

- Switches S3 and S4 serve to select the parameter set (see the following table).
- Switch S2 activates the change-over. Since the change-over is activated with a rising edge, a button (normally-open contact) can be used instead of a switch.
- Change-over is only possible if the motor is not started (switch S1 open).

1585 GB 09 18

Connection plan	Function			
	Switch S1	Run		
	Switch S2	Load parameter set		
	Switches S3 ... S4	Parameter set selection		
		<b>S3</b>	<b>S4</b>	
		Off	Off	Parameter set 1
		On	Off	Parameter set 2
		Off	On	Parameter set 3
	On	On	Parameter set 4	

Parameter	Name	Setting for this example
0x2631:001 (P400.01)	Enable inverter	Constant TRUE [1]
0x2631:002 (P400.02)	Run	Digital input 1 [11]
0x2631:004 (P400.04)	Reset fault	Not connected [0]
0x2631:013 (P400.13)	Reverse rotational direction	Not connected [0]
0x2631:018 (P400.18)	Activate preset (bit 0)	Not connected [0]
0x2631:040 (P400.40)	Load parameter set	Digital input 2 [12]
0x2631:041 (P400.41)	Select parameter set (bit 0)	Digital input 3 [13]
0x2631:042 (P400.42)	Select parameter set (bit 1)	Digital input 4 [14]
0x2824 (P200.00)	Control selection	Flexible I/O configuration [0]
0x4046 (P755.00)	Activation of parameter set	Via command (disable required) [0]

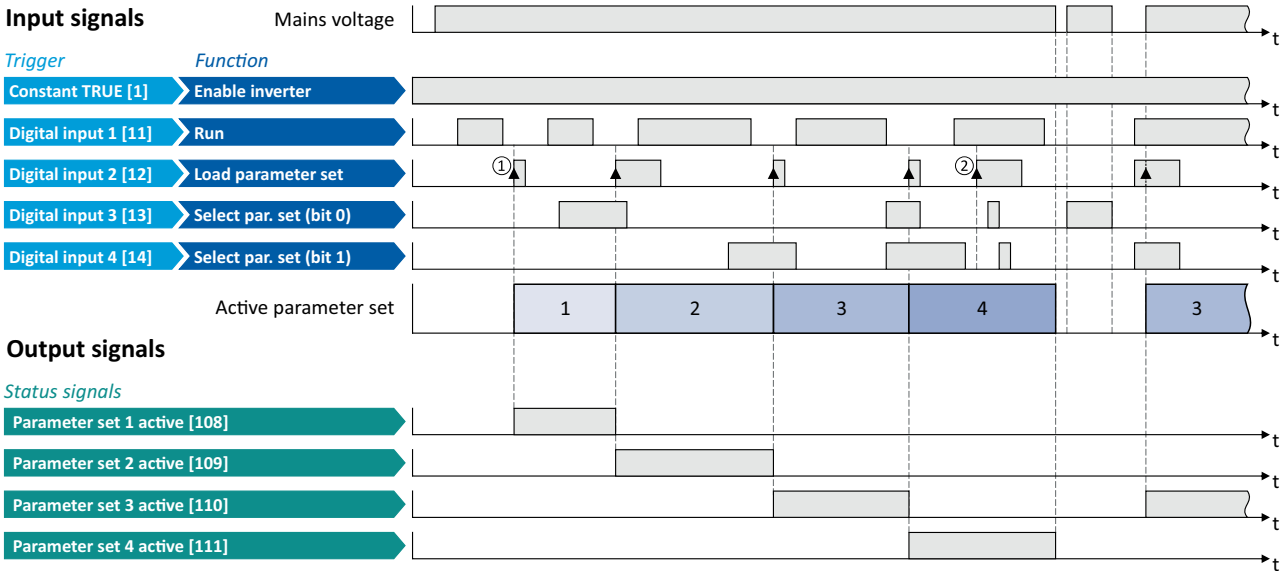

The status signals can be assigned to digital outputs. ▶ See chapter "Configuration of digital outputs".

- ① The change-over is activated with the "Load parameter set" function (FALSE/TRUE edge).
- ② If the variable speed drive is enabled and the motor is started, a change-over is not possible.

12.9.2 EXAMPLE 2: ACTIVATION VIA COMMAND (IMMEDIATELY)

Activation method 0x4046 (P755.00) = "Via command (immediately) [1]":

- Switches S3 and S4 serve to select the parameter set (see the following table).
- Switch S2 activates the change-over. Since the change-over is activated with a rising edge, a button (normally-open contact) can be used instead of a switch.
- Change-over takes place immediately, even if the motor is started (switch S1 closed).

Connection plan	Function
	Switch S1 Run
	Switch S2 Load parameter set
	Switches S3 ... S4 Parameter set selection
	<b>S3</b> <b>S4</b>
	Off    Off    Parameter set 1
	On    Off    Parameter set 2
	Off    On    Parameter set 3
On    On    Parameter set 4	

Parameter	Name	Setting for this example
0x2631:001 (P400.01)	Enable inverter	Constant TRUE [1]
0x2631:002 (P400.02)	Run	Digital input 1 [11]
0x2631:004 (P400.04)	Reset fault	Not connected [0]
0x2631:018 (P400.18)	Activate preset (bit 0)	Not connected [0]
0x2631:040 (P400.40)	Load parameter set	Digital input 2 [12]
0x2631:041 (P400.41)	Select parameter set (bit 0)	Digital input 3 [13]
0x2631:042 (P400.42)	Select parameter set (bit 1)	Digital input 4 [14]
0x2824 (P200.00)	Control selection	Flexible I/O configuration [0]
0x4046 (P755.00)	Activation of parameter set	Via command (immediately) [1]

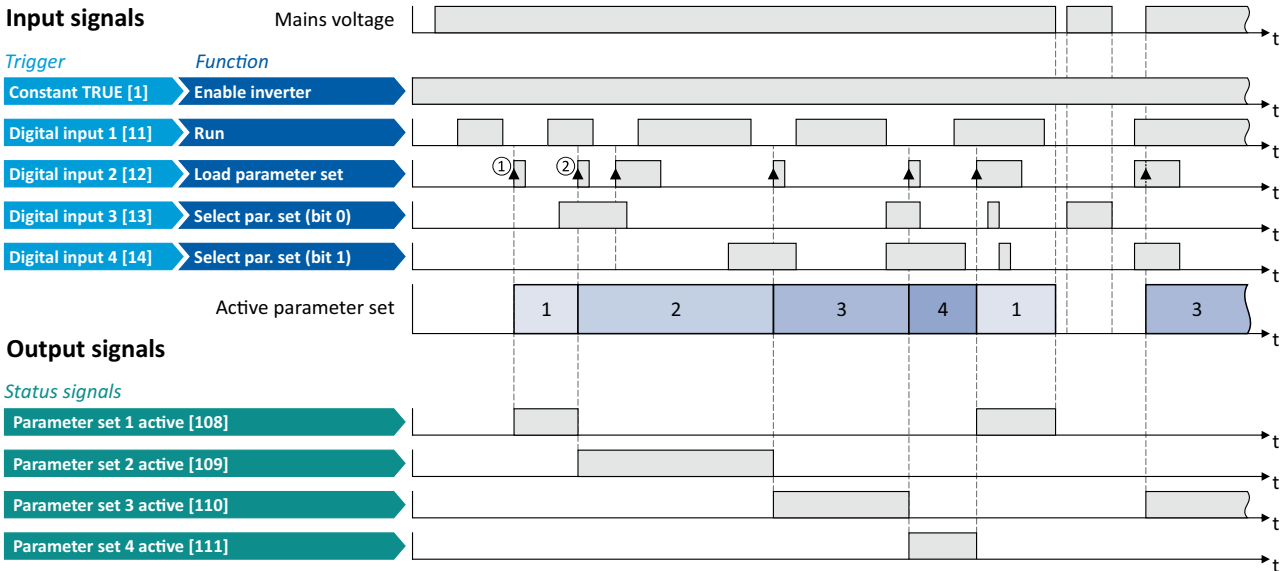

The status signals can be assigned to digital outputs. ▶ See chapter "Configuration of digital outputs".

- ① The change-over is activated with the "Load parameter set" function (FALSE/TRUE edge).
- ② Change-over is also possible if the variable speed drive is enabled and the motor is started.

12.9.3 EXAMPLE 3: ACTIVATION IF THE SELECTION IS CHANGED (ONLY IF THE VARIABLE SPEED DRIVE IS DISABLED)

Activation method 0x4046 (P755.00) = "If the selection is changed (disable required) [2]":

- Switches S3 and S4 serve to select the parameter set (see the following table). At the same time, the change-over is activated by a status change of the selection inputs.
- Change-over is only possible if the motor is not started (switch S1 open).
- Switch S2 ("Load parameter set") is ignored in this configuration.

1585 GB 09 18

Connection plan	Function
	Switch S1 Run
	Switch S2 Load parameter set (is ignored in this configuration).
	Switches S3 ... S4 Parameter set selection and activation at the same time:
	<b>S3</b> <b>S4</b>
	Off    Off    Parameter set 1
	On    Off    Parameter set 2
Off    On    Parameter set 3	
On    On    Parameter set 4	

Parameter	Name	Setting for this example
0x2631:001 (P400.01)	Enable inverter	Constant TRUE [1]
0x2631:002 (P400.02)	Run	Digital input 1 [11]
0x2631:004 (P400.04)	Reset fault	Not connected [0]
0x2631:013 (P400.13)	Reverse rotational direction	Not connected [0]
0x2631:018 (P400.18)	Activate preset (bit 0)	Not connected [0]
0x2631:040 (P400.40)	Load parameter set	Digital input 2 [12]
0x2631:041 (P400.41)	Select parameter set (bit 0)	Digital input 3 [13]
0x2631:042 (P400.42)	Select parameter set (bit 1)	Digital input 4 [14]
0x2824 (P200.00)	Control selection	Flexible I/O configuration [0]
0x4046 (P755.00)	Activation of parameter set	If the selection is changed (disable required) [2]

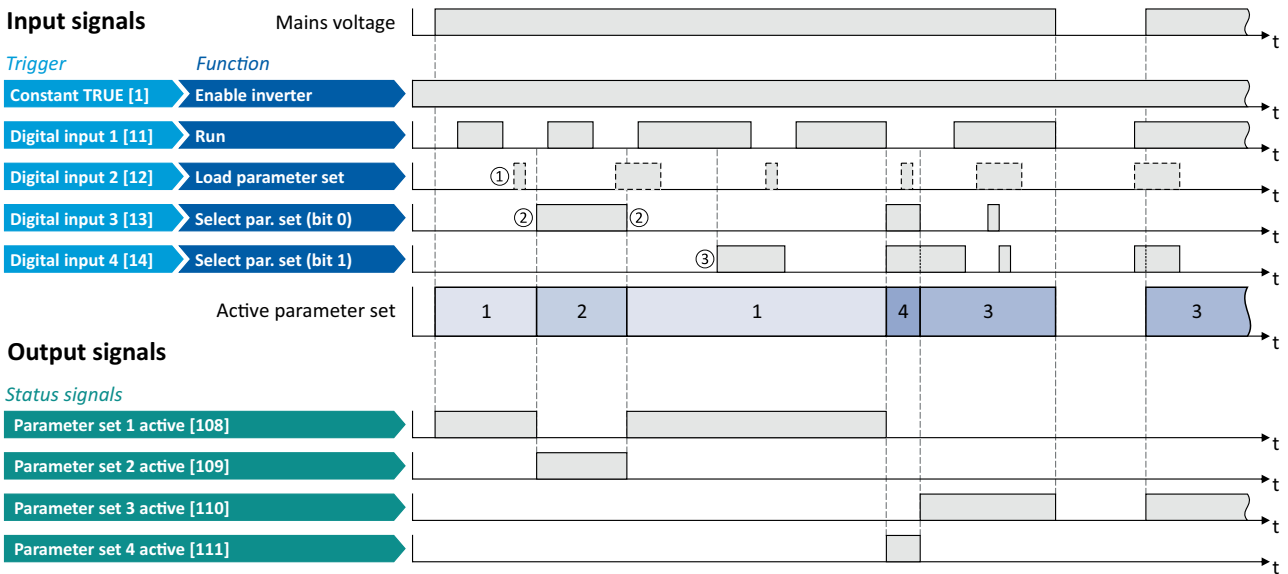

The status signals can be assigned to digital outputs. ▶ See chapter "Configuration of digital outputs".

- ① The "Load parameter set" function is ignored in this configuration.
- ② Change-over takes place by a status change of the selection inputs.
- ③ If the variable speed drive is enabled and the motor is started, a change-over is not possible.

12.9.4 EXAMPLE 4: ACTIVATION IF THE SELECTION IS CHANGED (IMMEDIATELY)

Activation method 0x4046 (P755.00) = "If the selection is changed (immediately) [3]":

- Switches S3 and S4 serve to select the parameter set (see the following table). At the same time the change-over is activated by a status change of the selection inputs.
- Change-over takes place immediately, even if the motor is started (switch S1 closed).
- Switch S2 ("Load parameter set") is ignored in this configuration.

1585 GB 09 18

Connection plan	Function
	Switch S1 Run
	Switch S2 Load parameter set (is ignored in this configuration).
	Switches S3 ... S4 Parameter set selection and activation at the same time:
	<b>S3</b> <b>S4</b>
	Off    Off    Parameter set 1
	On    Off    Parameter set 2
Off    On    Parameter set 3	
On    On    Parameter set 4	

Parameter	Name	Setting for this example
0x2631:001 (P400.01)	Enable inverter	Constant TRUE [1]
0x2631:002 (P400.02)	Run	Digital input 1 [11]
0x2631:004 (P400.04)	Reset fault	Not connected [0]
0x2631:013 (P400.13)	Reverse rotational direction	Not connected [0]
0x2631:018 (P400.18)	Activate preset (bit 0)	Not connected [0]
0x2631:040 (P400.40)	Load parameter set	Digital input 2 [12]
0x2631:041 (P400.41)	Select parameter set (bit 0)	Digital input 3 [13]
0x2631:042 (P400.42)	Select parameter set (bit 1)	Digital input 4 [14]
0x2824 (P200.00)	Control selection	Flexible I/O configuration [0]
0x4046 (P755.00)	Activation of parameter set	If the selection is changed (immediately) [3]

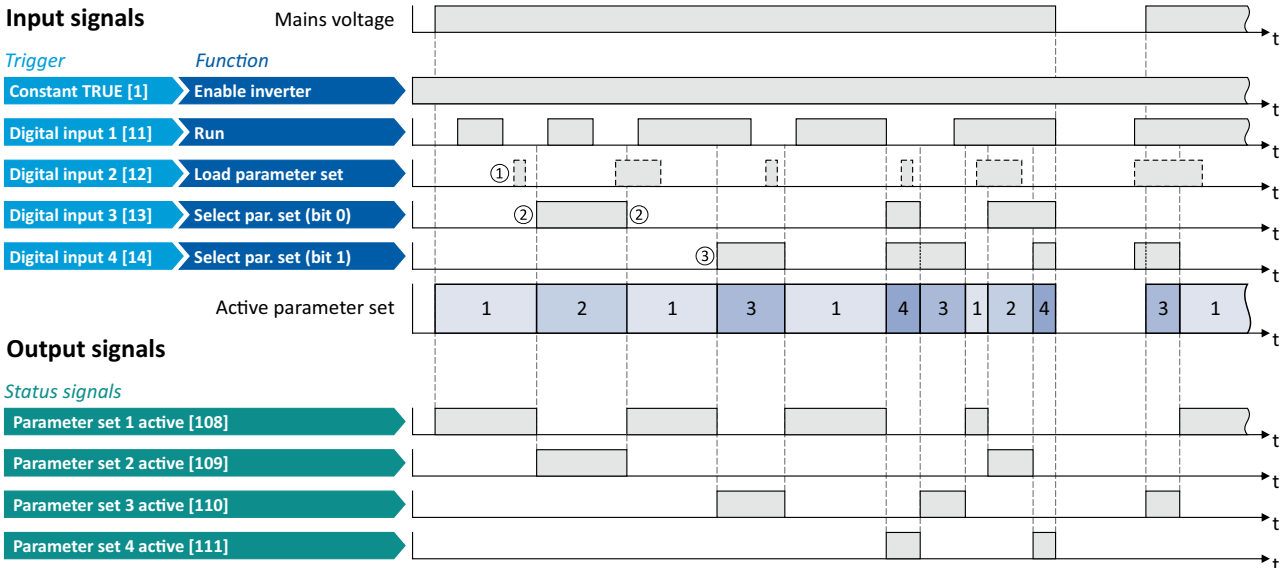

The status signals can be assigned to digital outputs. ▶ See chapter "Configuration of digital outputs".

- ① The "Load parameter set" function is ignored in this configuration.
- ② Change-over takes place by a status change of the selection inputs.
- ③ Change-over is also possible if the variable speed drive is enabled and the motor is started.

## 12.10 PROCESS CONTROLLER FUNCTION SELECTION

By means of the following functions, the response of the variable speed drive can be controlled when PID control is activated. ► See chapter "Configuring the process controller".

Parameter	Name / value range / [default setting]	Info
0x2631:045 (P400.45)	Function list: Deactivate PID controller (Function list: PID off) – For further possible settings, see parameter 0x2631:001 (P400.01).	Assignment of a trigger for the "Deactivate PID controller" function. Trigger = TRUE: If PID control is activated, ignore PID control and drive the motor in speed-controlled manner. Trigger = FALSE: If PID control is activated, drive the motor with PID control.
	<b>0 Not connected</b>	Notes: – The PID control mode can be selected in 0x4020:001 (P600.01).
0x2631:046 (P400.46)	Function list: Set process controller output to 0 (Function list: PID output=0) – For further possible settings, see parameter 0x2631:001 (P400.01).	Assignment of a trigger for the "Set process controller output to 0" function. Trigger = TRUE: If PID control is activated, I component and the output of the PID controller are set to 0 and the internal control algorithm is stopped. The PID control remains active. Trigger = FALSE: no action / deactivate function again.
	<b>0 Not connected</b>	
0x2631:047 (P400.47)	Function list: Inhibit process controller I-component (Function list: PID-I inhibited) – For further possible settings, see parameter 0x2631:001 (P400.01).	Assignment of a trigger for the "Inhibit process controller I-component" function. Trigger = TRUE: If PID control is activated, the I component of the PID controller is set to 0 and the integration process is stopped. Trigger = FALSE: no action / deactivate function again.
	<b>0 Not connected</b>	Notes: – The reset time can be set in 0x4049 (P602.00).
0x2631:048 (P400.48)	Function list: Activate PID influence ramp (Function list: PID-Inf ramp on) – For further possible settings, see parameter 0x2631:001 (P400.01).	Assignment of a trigger for the "Activate PID influence ramp" function. Trigger = TRUE: the influence of the process controller is shown via a ramp. Trigger = FALSE or not connected: the influence of the process controller is hidden via ramp.
	<b>1 Constant TRUE</b>	Notes: – The influence of the process controller is always active (not only when PID control is activated) – Acceleration time for showing the influence of the process controller can be set in 0x404C:001 (P607.01). – Deceleration time for hiding the influence of the process controller can be set in 0x404C:002 (P607.02).
0x4020:001 (P600.01)	Process controller setup (PID): Operating mode (PID setup: Operating mode).	Selection of the process controller operating mode
	<b>0 Inhibited</b>	Process controller deactivated
	1 Normal operation	The setpoint is higher than the fed back variable (actual value). If the system deviation increases, the motor speed is increased. Example: pressure-controlled booster pumps (increase in the motor speed produces an increase in pressure).
	2 Reverse operation	The setpoint is lower than the fed back variable (actual value). If the system deviation increases, the motor speed is increased. Example: temperature-controlled cooling water pump (increase in motor speed produces decrease in temperature).
	3 Normal bi-directional	The direction of rotation corresponds to the sign of the system deviation. If the system deviation increases, the motor speed is increased.
4 Reverse bi-directional	A negative system deviation causes a positive direction of rotation. If the system deviation increases, the motor speed is increased.	
0x4049 (P602.00)	PID I- component (PID I- component) 10 ... [400] ... 6000 ms	Reset time for system deviation. – With the setting "6000 ms", the I component is deactivated. – The I component can also be deactivated via the "Inhibit process controller I-component" 0x2631:047 (P400.47) function.
0x404C:001 (P607.01)	PID influence: Acceleration time for activation (PID influence: Activation time) 0.0 ... [5.0] ... 999.9 s	If the trigger assigned in 0x2631:048 (P400.48) of the "Activate PID influence ramp" function is TRUE, the influence of the process controller is shown by means of a ramp with the acceleration time set here.
0x404C:002 (P607.02)	PID influence: Deceleration time for masking out (PID influence: Mask out time) 0.0 ... [5.0] ... 999.9 s	If the trigger assigned in 0x2631:048 (P400.48) of the "Activate PID influence ramp" function is FALSE, the influence of the process controller is hidden via a ramp with the deceleration time set here.

Example for operating mode

In the following example, the "Deactivate PID controller" function is used to deactivate the PID control temporarily:

- As standard setpoint source, the frequency preset 1 is set to 20 Hz.
- Switch S1 starts the motor in forward direction of rotation. Switch S1 in the initial position stops the motor again.
- Switch S2 deactivates the PID control. The motor is then driven in a speed-controlled way.

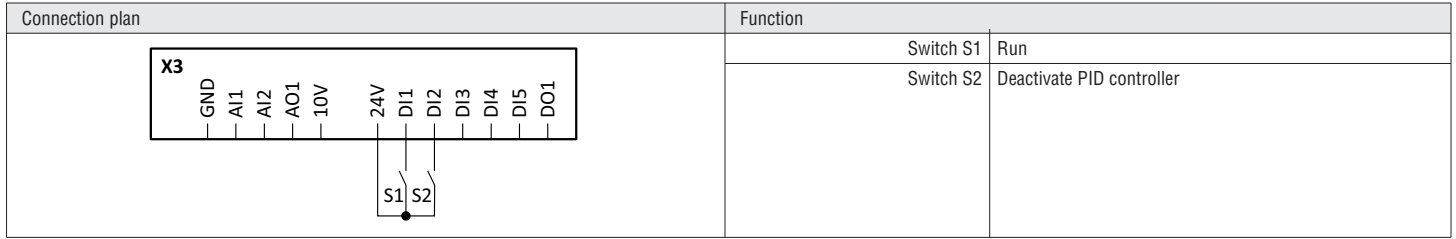

1585 GB 09 18

Parameter	Name	Setting for this example
0x2631:001 (P400.01)	Enable inverter	Constant TRUE [1]
0x2631:002 (P400.02)	Run	Digital input 1 [11]
0x2631:004 (P400.04)	Reset fault	Not connected [0]
0x2631:045 (P400.45)	Deactivate PID controller	Digital input 2 [12]
0x2824 (P200.00)	Control selection	Flexible I/O configuration [0]
0x2838:003 (P203.03)	Stop method	Standard ramp [1]
0x2860:001 (P201.01)	Frequency control: Default setpoint source	Frequency preset 1 [11]
0x2911:001 (P450.01)	Frequency setpoint presets: Preset 1	20 Hz
0x2916 (P211.00)	Maximum frequency	50 Hz

**i** The example assumes that the process controller has been configured accordingly. ▶ See chapter "Configuring the process controller".

### Input signals

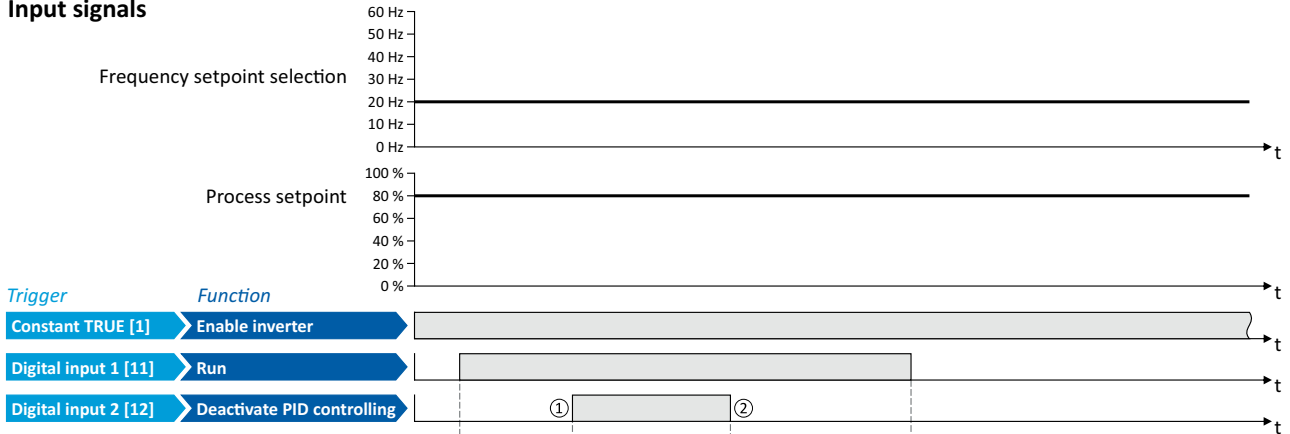

### Output signals

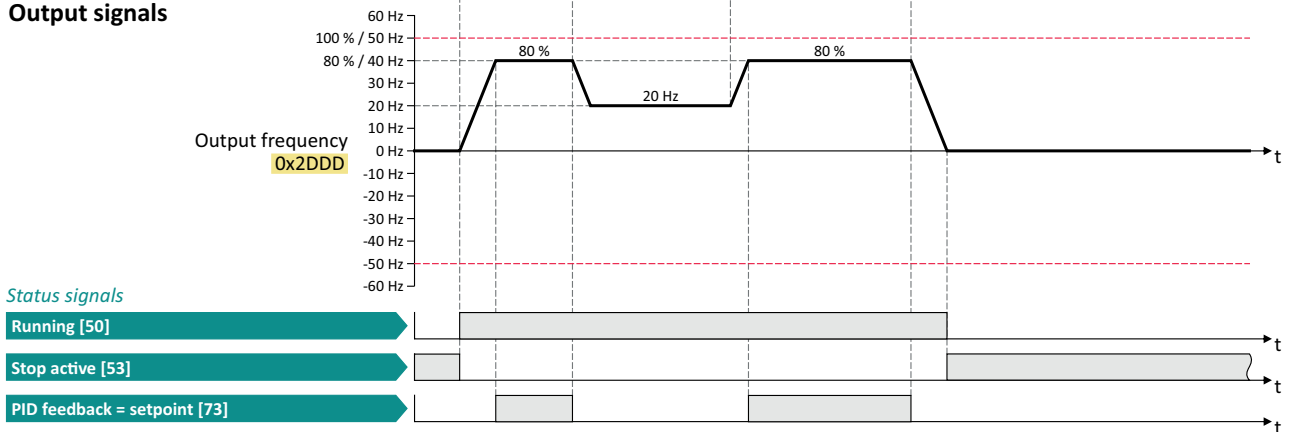

The status signals can be assigned to digital outputs. ▶ See chapter "Configuration of digital outputs".

- ① PID control is deactivated: Change-over from the configured PID control to the speed-controlled operation.
- ② PID control is activated again: Change-over from the speed-controlled operation to the configured PID control.



## 12.11 SEQUENCER CONTROL FUNCTION

The following functions serve to control the sequencer. See chapter "Sequencer".

### Select sequence

A sequence is selected in a binary-coded fashion via the triggers assigned to the four function "Select sequence (bit 0)" ... "Select sequence (bit 3)" in compliance with the following truth table:

Select sequence				Selection
Bit 3 0x2631:053 (P400.53)	Bit 2 0x2631:052 (P400.52)	Bit 1 0x2631:051 (P400.51)	Bit 0 0x2631:050 (P400.50)	
FALSE	FALSE	FALSE	FALSE	No sequence selected
FALSE	FALSE	FALSE	TRUE	Sequence 1
FALSE	FALSE	TRUE	FALSE	Sequence 2
FALSE	FALSE	TRUE	TRUE	Sequence 3
FALSE	TRUE	FALSE	FALSE	Sequence 4
FALSE	TRUE	FALSE	TRUE	Sequence 5
FALSE	TRUE	TRUE	FALSE	Sequence 6
FALSE	TRUE	TRUE	TRUE	Sequence 7
TRUE	FALSE	FALSE	FALSE	Sequence 8
TRUE	FALSE	FALSE	TRUE	Invalid selection
...				
TRUE	TRUE	TRUE	TRUE	

1585 GB 09 18

### Start sequence

The selected sequence is not started automatically. For starting the sequence, two functions are available:

- 0x2631:030 (P400.30): Run/abort sequence (status-controlled start)
- 0x2631:031 (P400.31): Start sequence (edge-controlled start)

### Further control functions

The following functions serve to control the started sequence:

- 0x2631:032 (P400.32): Next sequence step
- 0x2631:033 (P400.33): Pause sequence
- 0x2631:034 (P400.34): Suspend sequence
- 0x2631:035 (P400.35): Stop sequence
- 0x2631:036 (P400.36): Abort sequence

Parameter	Name / value range / [default setting]	Info
0x2631:030 (P400.30)	Function list: Run/abort sequence (Function list: Seq: Run/abort) - Setting can only be changed if the variable speed drive is inhibited. - For further possible settings, see parameter 0x2631:001 (P400.01).	Assignment of a trigger for the "Run/abort sequence" function. Trigger = TRUE: Start selected sequence. Trigger = FALSE: Abort sequence.  Notes: - The assigned trigger must remain set to TRUE for the duration of the sequence. - If the trigger bit is reset to FALSE, the sequence is aborted. In this case, the standard setpoint or the setpoint source selected via setpoint change-over is active again. - A sequence is selected in a binary-coded fashion via the trigger assigned to the four functions "Select sequence (bit 0)" 0x2631:050 (P400.50) ... "Select sequence (bit 3)" 0x2631:053 (P400.53). - For an edge-controlled start, the function "Start sequence" 0x2631:031 (P400.31) is optionally available.
	<b>0</b> Not connected	
0x2631:031 (P400.31)	Function list: Start sequence (Function list: Seq: Start) - Setting can only be changed if the variable speed drive is inhibited. - For further possible settings, see parameter 0x2631:001 (P400.01).	Assignment of a trigger for the "Start sequence" function. Trigger = FALSE↗TRUE (edge): Start selected sequence. Trigger = TRUE↘FALSE (edge): No action.  Notes: - After the start, the sequencer remains activated until the function "Stop sequence" 0x2631:035 (P400.35) or the function "Abort sequence" 0x2631:036 (P400.36) is executed. A normal stop command does not reset the start command for the sequencer. For a status-controlled start, the function "Run/abort sequence" 0x2631:030 (P400.30) is optionally available.
	<b>0</b> Not connected	
0x2631:032 (P400.32)	Function list: Next sequence step (Function list: Seq: Next step) - Setting can only be changed if the variable speed drive is inhibited. - For further possible settings, see parameter 0x2631:001 (P400.01).	Assignment of a trigger for the "Next sequence step" function. Trigger = FALSE↗TRUE (edge): Next sequence step. Trigger = TRUE↘FALSE (edge): No action.  Notes: - The execution of the current step is completed even if the time parameterised for the segment has not elapsed yet. - The function is only relevant for Sequencer mode 0x4025 (P800.00) = "Step operation [2]" or "Time & step operation [3]". - A jump to the next sequence step is not possible if the sequence pauses, the sequence is suspended or the final segment is executed.
	<b>0</b> Not connected	
0x2631:033 (P400.33)	Function list: Pause sequence (Function list: Seq: Pause) - Setting can only be changed if the variable speed drive is inhibited. - For further possible settings, see parameter 0x2631:001 (P400.01).	Assignment of a trigger for the "Pause sequence" function. Trigger = TRUE: Pause sequence. Trigger = FALSE: Continue sequence.  Notes: - During the pause, the sequence stops in the current step. The expiration of the time set for the segment is stopped. - The sequencer setpoint continues to remain active.
	<b>0</b> Not connected	

Parameter	Name / value range / [default setting]	Info
0x2631:034 (P400.34)	Function list: Suspend sequence (Function list: Seq: Suspense) – Setting can only be changed if the variable speed drive is inhibited. – For further possible settings, see parameter 0x2631:001 (P400.01).	Assignment of a trigger for the "Suspend sequence" function. Trigger = TRUE: Suspend sequence. Trigger = FALSE: Continue sequence.  Notes: – This function serves to temporarily change over to the standard setpoint or the setpoint source selected via setpoint change-over. – The sequence is continued at the point where it was suspended.
	<b>0</b> Not connected	
0x2631:035 (P400.35)	Function list: Stop sequence (Function list: Seq: Stop) – Setting can only be changed if the variable speed drive is inhibited. – For further possible setting see parameter 0x2631:001 (P400.01).	Assignment of a trigger for the "Stop sequence" function. Trigger = FALSE→TRUE (edge): Stop sequence. Trigger = TRUE→FALSE (edge): No action.  Notes: – If the sequence is stopped, it is jumped to the final segment. – The further execution depends on the selected End of sequence mode 0x402F (P824.00).
	<b>0</b> Not connected	
0x2631:036 (P400.36)	Function list: Abort sequence (Function list: Seq: Abort) – Setting can only be changed if the variable speed drive is inhibited. – For further possible settings, see parameter 0x2631:001 (P400.01).	Assignment of a trigger for the "Abort sequence" function. Trigger = FALSE→TRUE (edge): Abort sequence. Trigger = TRUE→FALSE (edge): No action.  Notes: – This function serves to directly stop the sequence without the final segment being executed. In this case, the standard setpoint or the setpoint source selected via setpoint change-over is active again.
	<b>0</b> Not connected	
0x2631:050 (P400.50)	Function list: Select sequence (bit 0) (Function list: Seq: Select. b0) – Setting can only be changed if the variable speed drive is inhibited. – For further possible settings, see parameter 0x2631:001 (P400.01).	Assignment of a trigger for the "Select sequence (bit 0)" function. Selection bit with the valency 20 for bit coded selection of a sequence. Trigger = FALSE: selection bit = "0". Trigger = TRUE: selection bit = "1".  Notes: – The selected sequence is not started automatically. – For a status-controlled start, the function "Run/abort sequence" 0x2631:030 (P400.30) is available. – For an edge-controlled start, the function "Start sequence" 0x2631:031 (P400.31) is available.
	<b>0</b> Not connected	
0x2631:051 (P400.51)	Function list: Select sequence (bit 1) (Function list: Seq: Select. b1) – Setting can only be changed if the variable speed drive is inhibited. – For further possible settings, see parameter 0x2631:001 (P400.01).	Assignment of a trigger for the "Select sequence (bit 1)" function. Selection bit with the valency 21 for the bit-coded selection of a sequence. Trigger = FALSE: selection bit = "0". Trigger = TRUE: selection bit = "1".  Notes: – The selected sequence is not started automatically. – For a status-controlled start, the function "Run/abort sequence" 0x2631:030 (P400.30) is available. – For an edge-controlled start, the function "Start sequence" 0x2631:031 (P400.31) is available.
	<b>0</b> Not connected	
0x2631:052 (P400.52)	Function list: Select sequence (bit 2) (Function list: Seq: Select. b2) – Setting can only be changed if the variable speed drive is inhibited. – For further possible settings, see parameter 0x2631:001 (P400.01).	Assignment of a trigger for the "Select sequence (bit 2)" function. Selection bit with the valency 22 for the bit-coded selection of a sequence. Trigger = FALSE: selection bit = "0". Trigger = TRUE: selection bit = "1".  Notes: – The selected sequence is not started automatically. – For a status-controlled start, the function "Run/abort sequence" 0x2631:030 (P400.30) is available. – For an edge-controlled start, the function "Start sequence" 0x2631:031 (P400.31) is available.
	<b>0</b> Not connected	
0x2631:053 (P400.53)	Function list: Select sequence (bit 3) (Function list: Seq: Select. b3) – Setting can only be changed if the variable speed drive is inhibited. – For further possible settings, see parameter 0x2631:001 (P400.01).	Assignment of a trigger for the "Select sequence (bit 3)" function. Selection bit with the valency 23 for the bit-coded selection of a sequence. Trigger = FALSE: selection bit = "0". Trigger = TRUE: selection bit = "1".  Notes: – The selected sequence is not started automatically. – For a status-controlled start, the function "Run/abort sequence" 0x2631:030 (P400.30) is available. – For an edge-controlled start, the function "Start sequence" 0x2631:031 (P400.31) is available.
	<b>0</b> Not connected	

Example for operating mode

In the following example, the digital inputs 2 and 3 are used for controlling the sequencer.

- The analog input 1 is set as standard setpoint source.
- Switch S1 starts the motor in forward direction of rotation. Switch S1 in the initial position stops the motor again.
- Button S2 starts the sequence, button S3 aborts the sequence. After the abortion, the normal setpoint control is active again.

Connection plan	Function
	Potentiometer R1
	Frequency setpoint selection
	Switch S1
	Run
Button S2	Start sequence
Button S3	Abort sequence

1585 GB 09 18

Parameter	Designation	Setting for this example
0x2631:001 (P400.01)	Enable inverter	Constant TRUE [1]
0x2631:002 (P400.02)	Run	Digital input 1 [11]
0x2631:004 (P400.04)	Reset fault	Not connected [0]
0x2631:013 (P400.13)	Reverse rotational direction	Not connected [0]
0x2631:031 (P400.31)	Start sequence	Digital input 2 [12]
0x2631:036 (P400.36)	Abort sequence	Digital input 3 [13]
0x2631:050 (P400.50)	Select sequence (bit 0)	Constant TRUE [1]
0x2634:001 (P420.01)	Relay	Sequencer controlled [100]
0x2634:002 (P420.02)	Digital output 1	Sequencer controlled [100]
Segment and sequence configuration. In this example, only the sequence 1 is used. The sequence consists of two steps (segment 1 and segment 2).		
0x4026:001 (P801.01)	Sequencer segment 1: Frequency setpoint	40 Hz
0x4026:002 (P801.02)	Sequencer segment 1: Acceleration/deceleration	20 s
0x4026:003 (P801.03)	Sequencer segment 1: Time	18 s
0x4026:004 (P801.04)	Sequencer segment 1: Digital outputs	0x00
0x4027:001 (P802.01)	Sequencer segment 2: Frequency setpoint	30 Hz
0x4027:002 (P802.02)	Sequencer segment 2: Acceleration/deceleration	15 s
0x4027:003 (P802.03)	Sequencer segment 2: Time	14 s
0x4027:004 (P802.04)	Sequencer segment 2: Digital outputs	0x02 (only relay)
0x402E:001 (P822.01)	End segment: Frequency setpoint	10 Hz
0x402E:002 (P822.02)	End segment: Acceleration/deceleration	8 s
0x402E:003 (P822.03)	End segment: Time	10 s
0x402E:004 (P822.04)	End segment: Digital outputs	0x04 (only digital output 1)
0x4030:001 ... 0x4030:016 (P830.01 ... 16)	Sequence 1: Step 1	Segment 1 [1]
	Sequence 1: Step 2	Segment 2 [2]
	Sequence 1: Step 3	Skip step [0]
	...	...
	Sequence 1: Step 16	Skip step [0]
Sequencer basic settings		
0x4025 (P800.00)	Sequencer mode	Time operation [1]
0x402F (P824.00)	End of sequence mode	Keep running [0]
0x4040 (P820.00)	Start of sequence mode	Restart sequencer [0]

### Input signals

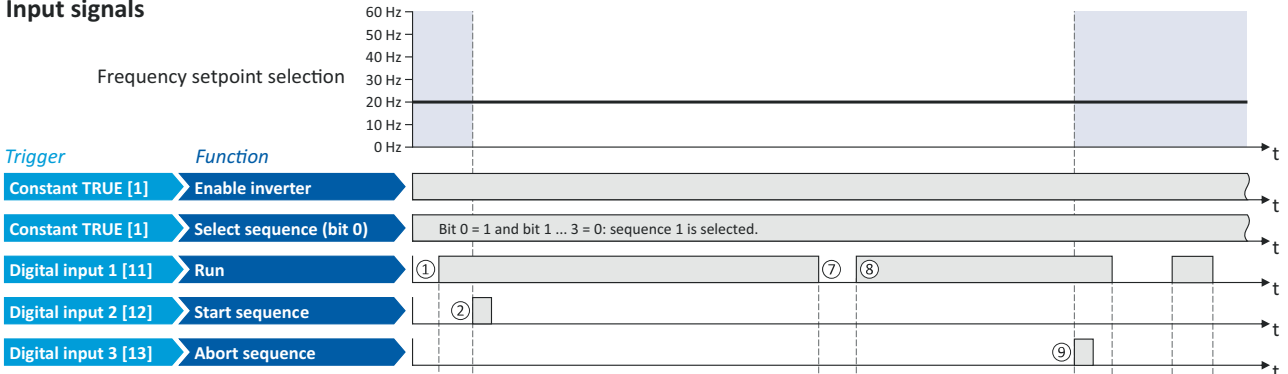

### Output signals

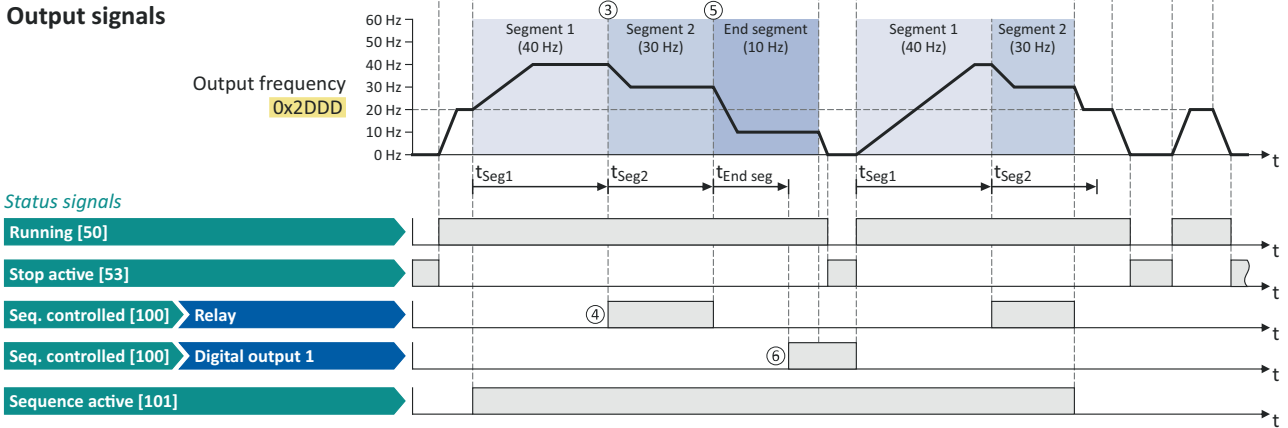

The status signals can be assigned to digital outputs. ▶ See chapter "Configuration of digital outputs".

- ① If the variable speed drive is enabled and no error is active, the motor can be started with the "Run" function. As the sequence has not been started yet, first the normal setpoint control is active.
- ② The "Start sequence" function is used to start the selected sequence in an edge-controlled way.
- ③ Sequencer mode 0x4025 (P800.00) = "Time operation [1]":  
The switch-over to the next step of the sequence is made after the time set for the current segment has elapsed.
- ④ The segment 2 is configured here in such a way that the relay will be triggered during the time of processing.
- ⑤ End of sequence mode 0x402F (P824.00) = "Keep running [0]":  
After the sequence has been processed, the setpoint set for the end segment is continuously transmitted to the motor control until the sequence is aborted.
- ⑥ In case of the end segment, the time setting determines the delay after which the configured output states are to become active. Here, the end segment is configured in such a way that the digital output 1 is set after 10 s have expired.
- ⑦ If the "Run" function is set to FALSE, the motor is stopped with the stop method set in 0x2838:003 (P203.03). The started sequence, however, remains active and the sequencer-controlled outputs keep their state.
- ⑧ Start of sequence mode 0x4040 (P820.00) = "Restart sequencer [0]":  
If the "Run" function is set to TRUE again, the (still active) sequence is restarted.
- ⑨ The "Abort sequence" function is used to abort the sequence in an edge-controlled way.  
In this case, the standard setpoint or the setpoint source selected via setpoint change-over is active again.

## 12.12 FREQUENCY THRESHOLD FOR "FREQUENCY THRESHOLD EXCEEDED" TRIGGER

As a function of the current output frequency, the adjustable frequency threshold serves to trigger a certain function or set a digital output.

Parameter	Name / value range / [default setting]	Info
0x4005 (P412.00)	Frequency threshold (Freq. threshold) 0.0 ... [0.0] ... 599.0 Hz	Threshold for the "Frequency threshold exceeded [70]" trigger. – The "Frequency threshold exceeded [70]" trigger is TRUE if the current output frequency is higher than the set threshold. – The trigger can be assigned to a function or to a digital output.

Example for operating mode

In the following example, the digital output 1 is set to TRUE if the output frequency is higher than 20 Hz.

- The analog input 1 is set as standard setpoint source.
- Switch S1 starts the motor in forward direction of rotation. Switch S1 in the initial position stops the motor again.

1585 GB 09 18

Connection plan	Function
	Potentiometer R1
	Switch S1
	Frequency setpoint selection
	Run

Parameter	Name	Setting for this example
0x2631:001 (P400.01)	Enable inverter	Constant TRUE [1]
0x2631:002 (P400.02)	Run	Digital input 1 [11]
0x2634:002 (P420.02)	Digital outputs function: Digital output 1	Frequency threshold exceeded [70]
0x2824 (P200.00)	Control selection	Flexible I/O configuration [0]
0x2860:001 (P201.01)	Frequency control: Default setpoint source	Analog input 1 [2]
0x4005 (P412.00)	Frequency threshold	20 Hz

### Input signals

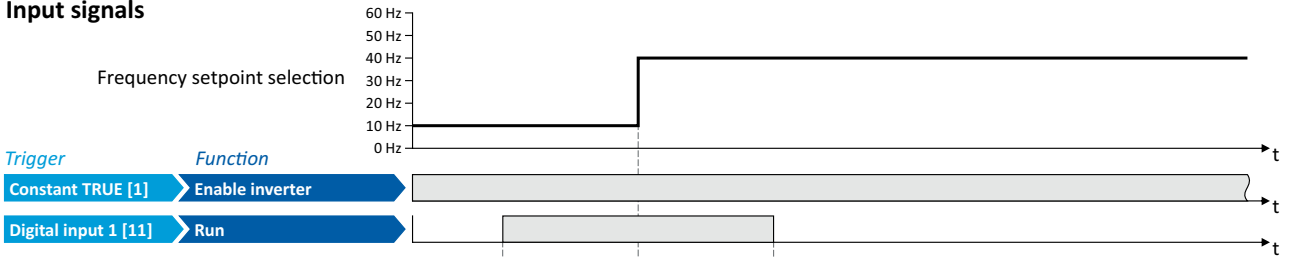

### Output signals

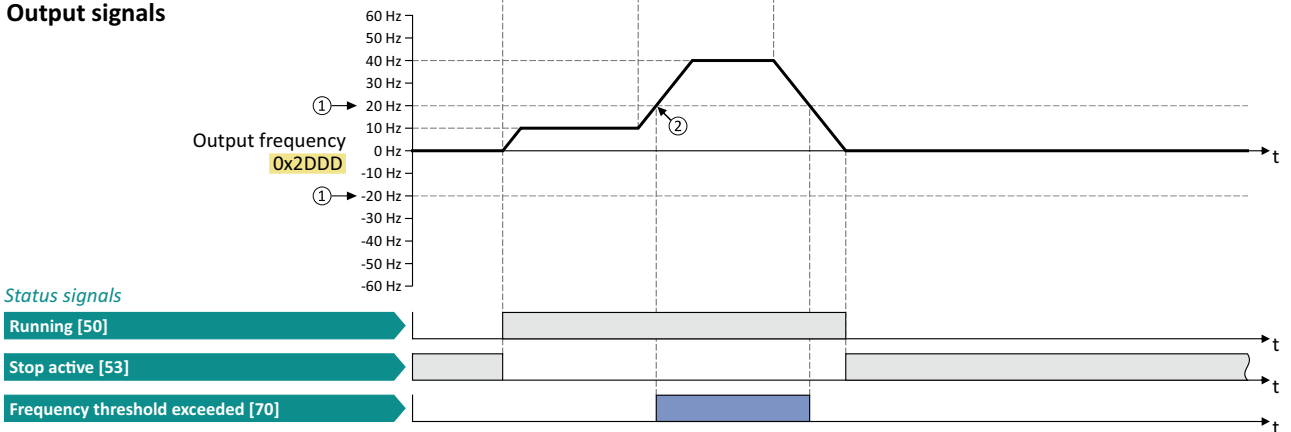

The status signals can be assigned to digital outputs. ▶ See chapter "Configuration of digital outputs".

- ① Frequency threshold 0x4005 (P412.00).
- ② Frequency threshold exceeded: Via trigger "Frequency threshold exceeded [70]", the digital output 1 is set to TRUE.

## 12.13 CONFIGURATION OF DIGITAL INPUTS

Settings for digital inputs 1 ... 5.

Parameter	Name / value range / [default setting]	Info
0x2630:002 (P410.02)	Setting for digital inputs: Input function (DI settings: Input function)	Input function of the digital terminals DI3 and DI4.
	<b>0</b> Digital input	DI3 = digital input DI4 = digital input
0x2632:001 (P411.01)	Inversion of digital inputs: Digital input 1 (DI inversion: DI1 inversion)	Inversion of digital input 1
	<b>0</b> Not inverted 1 Inverted	
0x2632:002 (P411.02)	Inversion of digital inputs: Digital input 2 (DI inversion: DI2 inversion)	Inversion of digital input 2
	<b>0</b> Not inverted 1 Inverted	
0x2632:003 (P411.03)	Inversion of digital inputs: Digital input 3 (DI inversion: DI3 inversion)	Inversion of digital input 3
	<b>0</b> Not inverted 1 Inverted	
0x2632:004 (P411.04)	Inversion of digital inputs: Digital input 4 (DI inversion: DI4 inversion)	Inversion of digital input 4
	<b>0</b> Not inverted 1 Inverted	
0x2632:005 (P411.05)	Inversion of digital inputs: Digital input 5 (DI inversion: DI5 inversion)	Inversion of digital input 5
	<b>0</b> Not inverted 1 Inverted	

1585 GB 09 18

Example: Activating two functions simultaneously via digital input 4

The principle of assigning triggers to functions also enables a digital input to be assigned to several functions. The wiring complexity is reduced since there is no necessity to interconnect several digital inputs.

If, for instance, the frequency preset 1 is to be selected via the digital input 4 and a change-over to the acceleration tim 2 and deceleration tim 2 is to take place at the same time, this can be easily realised by the following parameter setting:

Parameter	Name	Setting for this example
0x2631:018 (P400.18)	Activate preset (bit 0)	Digital input 4 [14]
0x2631:039 (P400.39)	Activate ramp 2	Digital input 4 [14]

**i** In order to achieve the desired behaviour, the digital input 4 must not be assigned to any further functions.

12.14.1 ANALOG INPUT 1

Settings for analog input 1.

Details

The analog input 1 can be used as setpoint source. ▶ See chapter "Selection of setpoint source".

For the process controller, the analog input can be used for the feedback of the variable (actual value) or speed feedforward control. ▶ See chapter "Basic process controller settings".

The following settings are possible for the analog input:

- Definition of the input range ①
- Filter time for low-pass filter ②
- Monitoring of the input signal ③
- Dead band for eliminating the smallest signal levels ④
- Definition of the setting range ⑤

1585 GB 09 18

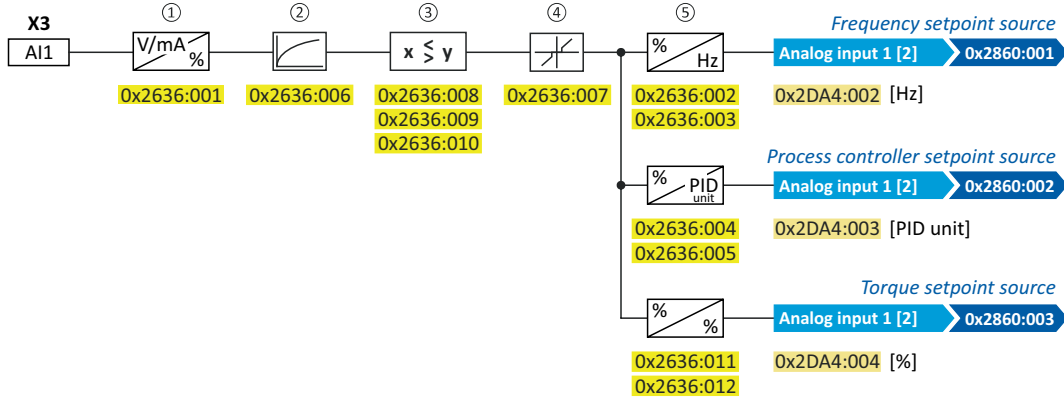

Diagnostic parameters:

- The frequency value is displayed in 0x2DA4:002 (P110.02).
- The process controller value is displayed in 0x2DA4:003 (P110.03).
- The torque value is displayed in 0x2DA4:004 (P110.04).

Definition of the input range

The analog input can be configured as voltage or current input. Internally, the signal is always converted to a value in percent.

Definition of the setting range

The setting range results from the set min and max value for the respective mode.

Configuration examples

Detailed configuration examples can be found in the following subchapters:

- ▶ Example 1: Input range 0 ... 10 V ≙ setting range 0 ... 50 Hz .
- ▶ Example 2: Input range 0 ... 10 V ≙ setting range -40 ... +40 Hz .
- ▶ Example 3: Error detection.

Parameter	Name / value range / [default setting]	Info
0x2636:001 (P430.01)	Analog input 1: Input range (Analog input 1: AI1 input range)	Definition of the input range.
	0 0 ... 10 VDC	
	1 0 ... 5 VDC	
	2 2 ... 10 VDC	
	4 4 ... 20 mA	
5 0 ... 20 mA		

Parameter	Name / value range / [default setting]	Info
0x2636:002 (P430.02)	Analog input 1: Min frequency value (Analog input 1: AI1 freq @ min) -1000.0 ... [0.0] ... 1000.0 Hz	Definition of the setting range for operating mode "MS: Velocity mode". – Direction of rotation according to sign. – The standard setpoint source for operating mode 0x6060 (P301.00) = "MS: Velocity mode [-2]" is selected in 0x2860:001 (P201.01).
0x2636:003 (P430.03)	Analog input 1: Max frequency value (Analog input 1: AI1 freq @ max) Device for 50-Hz mains: -1000.0 ... [50.0] ... 1000.0 Hz Device for 60-Hz mains: -1000.0 ... [60.0] ... 1000.0 Hz	
0x2636:004 (P430.04)	Analog input 1: Min PID value (Analog input 1: AI1 PID @ min) -300.00 ... [0.00] ... 300.00 PID unit	Definition of the setting range for PID control. – The standard setpoint source for the reference value of PID control is selected in 0x2860:002 (P201.02).
0x2636:005 (P430.05)	Analog input 1: Max PID value (Analog input 1: AI1 PID @ max) -300.00 ... [100.00] ... 300.00 PID unit	
0x2636:006 (P430.06)	Analog input 1: Filter time (Analog input 1: AI1 filter time) 0 ... [10] ... 10000 ms	PT1 time constant for low-pass filter – By the use of a low-pass filter, the impacts of noise to an analog signal can be minimised. – For an optimum filter effect, first the noise frequency has to be determined. The time constant then has to be set so that it equals the reciprocal value of the double frequency.
0x2636:007 (P430.07)	Analog input 1: Dead band (Analog input 1: AI1 dead band) 0.0 ... [0.0] ... 100.0 %	Optional setting of a dead band that is placed symmetrically around the frequency zero point. – The value set defines half the width of the dead band in [%]. – Example: Setting 2 % results in a dead band of 4 %. – If the analog input value is within the dead band, the output value for the motor control is set to "0".
0x2636:008 (P430.08)	Analog input 1: Monitoring threshold (Analog input 1: AI1 monit.level) -100.0 ... [0.0] ... 100.0 %	Monitoring threshold for analog input 1. – 100 % ≡ 10 V (with configuration as voltage input) – 100 % ≡ 20 mA (with configuration as current loop)
0x2636:009 (P430.09)	Analog input 1: Monitoring condition (Analog input 1: AI1 monit.cond.) <b>0</b> Input value < trigger threshold <b>1</b> Input value > trigger threshold	Monitoring condition for analog input 1. – If the selected condition is met, the "Error of analog input 1 active[81]" trigger is set to TRUE. The trigger can be assigned to a function or a digital output. – If the selected condition is met for at least 500 ms, the error response set in 0x2636:010 (P430.10) takes place.
0x2636:010 (P430.10)	Analog input 1: Error response (Analog input 1: AI1 error resp.) – For further possible settings, see parameter 0x2D45:001 (P310.01). <b>3</b> Fault	Error response for analog input 1. – The selected response takes place if the monitoring condition selected in 0x2636:009 (P430.09) is met for at least 500 ms.  Associated error code: – 28801   0x7081 - Error of analog input 1
0x2636:011 (P430.11)	Analog input 1: Min torque value (Analog input 1: Min. torque) -400.0 ... [0.0] ... 400.0 %	Definition of the setting range for operating mode "MS: Torque mode". – 100 % ≡ permissible maximum torque 0x6072 (P326.00) – Direction of rotation according to sign. – The standard setpoint source for operating mode 0x6060 (P301.00) = "MS: Torque mode [-1]" is selected in 0x2860:003 (P201.03). ▶ See chapter "Torque control w/ freq. limit".
0x2636:012 (P430.12)	Analog input 1: Max torque value (Analog input 1: Max. torque) -400.0 ... [100.0] ... 400.0 %	



12.14.1.1 EXAMPLE 1: INPUT RANGE 0 ... 10 V SETTING RANGE 0 ... 50 HZ

In this configuration, for instance, a frequency setpoint between 0 and 50 Hz can be set with a potentiometer connected to the analog input.

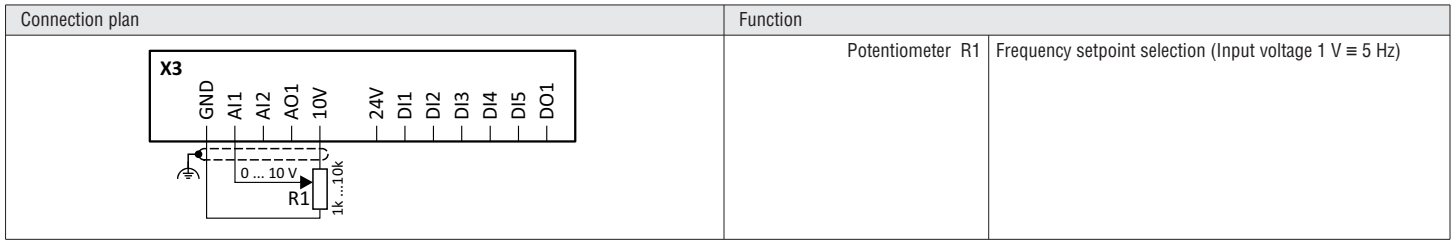

1585 GB 09 18

Parameter	Name	Setting for this example
0x2636:001 (P430.01)	Analog input 1: Input range	0 ... 10 VDC [0]
0x2636:002 (P430.02)	Analog input 1: Min frequency value	0.0 Hz
0x2636:003 (P430.03)	Analog input 1: Max frequency value	50.0 Hz
0x2636:006 (P430.06)	Analog input 1: Filter time	10 ms

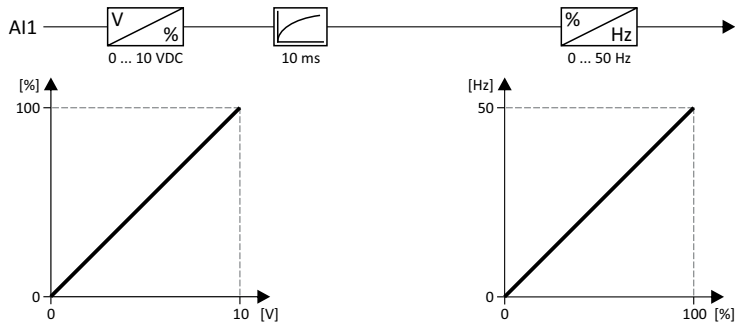

12.14.1.2 EXAMPLE 2: INPUT RANGE 0 ... 10 V SETTING RANGE -40 ... +40 HZ

In this example, a bipolar setting range and a dead band with 2 % are configured.

Parameter	Name	Setting for this example
0x2636:001 (P430.01)	Analog input 1: Input range	0 ... 10 VDC [0]
0x2636:002 (P430.02)	Analog input 1: Min frequency value	-40.0 Hz
0x2636:003 (P430.03)	Analog input 1: Max frequency value	40.0 Hz
0x2636:006 (P430.06)	Analog input 1: Filter time	10 ms
0x2636:007 (P430.07)	Analog input 1: Dead band	2.0 %

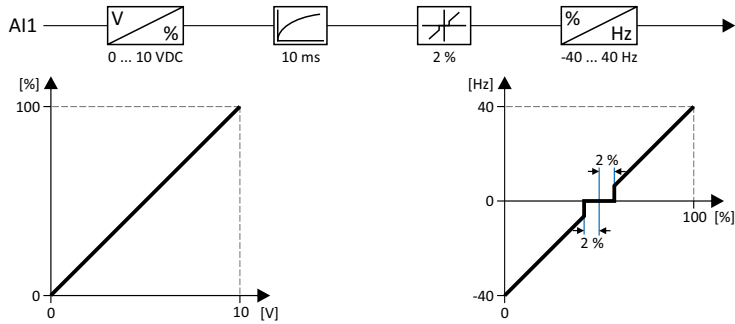

12.14.1.3 EXAMPLE 3: ERROR DETECTION

In this example, the digital output 1 is set via the trigger "Error of analog input 1 active [81]" if the percentage input value is lower than 10 %. Additionally, a warning is output.

Parameter	Name	Setting for this example
0x2634:002 (P420.02)	Digital outputs function Digital output 1	Error of analog input 1 active [81]
0x2636:001 (P430.01)	Analog input 1: Input range	0 ... 10 VDC [0]
0x2636:002 (P430.02)	Analog input 1: Min frequency value	0.0 Hz
0x2636:003 (P430.03)	Analog input 1: Max frequency value	40.0 Hz
0x2636:006 (P430.06)	Analog input 1: Filter time	10 ms
0x2636:008 (P430.08)	Analog input 1: Monitoring threshold	10.0 %
0x2636:009 (P430.09)	Analog input 1: Monitoring condition	Input value < trigger threshold [0]
0x2636:010 (P430.10)	Analog input 1: Error response	Warning [1]

1585 GB 09 18

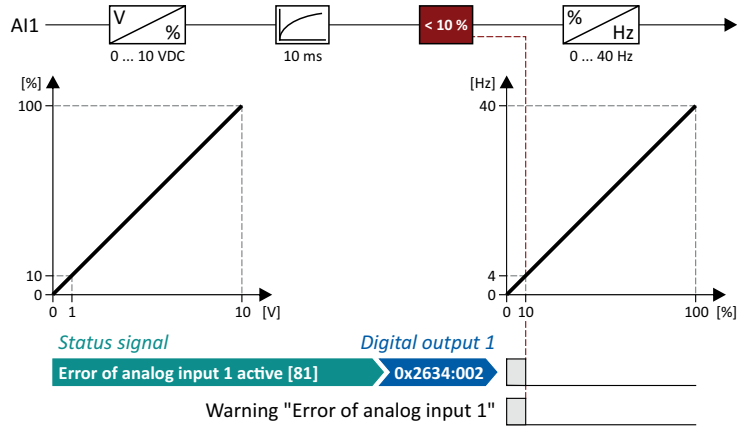

## 12.14.2 ANALOG INPUT 2 SETTINGS FOR ANALOG INPUT 2. DETAILS

The analog input 2 can be used as setpoint source. ▶ See chapter "Selection of setpoint source".

For the process controller, the analog input can be used for the feedback of the variable (actual value) or speed feedforward control. ▶ See chapter "Basic process controller settings".

The following settings are possible for the analog input:

- Definition of the input range ①
- Filter time for low-pass filter ②
- Monitoring of the input signal ③
- Dead band for eliminating the smallest signal levels ④
- Definition of the setting range ⑤

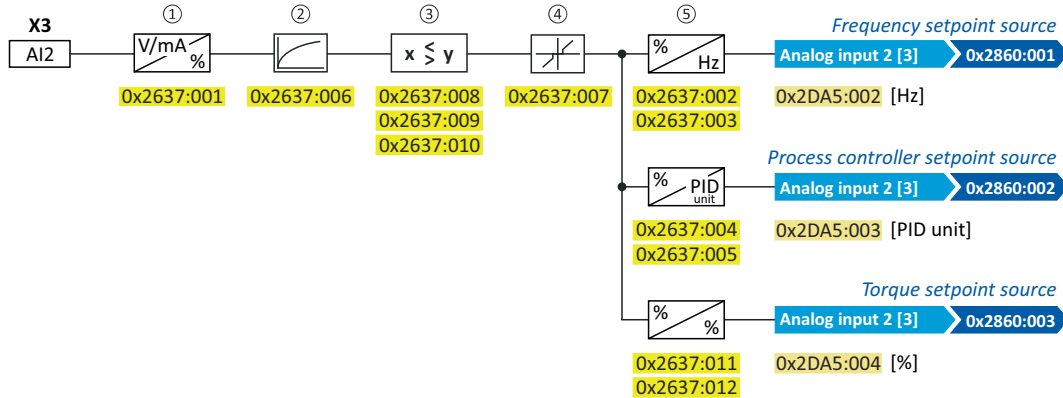

Diagnostic parameters:

- The frequency value is displayed in 0x2DA5:002 (P111.02).
- The process controller value is displayed in 0x2DA5:003 (P111.03).
- The torque value is displayed in 0x2DA5:004 (P111.04).

For further details and configuration examples, see chapter "Analog input 1".

Parameter	Name / value range / [default setting]	Info
0x2637:001 (P431.01)	Analog input 2: Input range (Analog input 2: AI2 input range)	Definition of the input range.
	0 0 ... 10 VDC	
	1 0 ... 5 VDC	
	2 2 ... 10 VDC	
0x2637:002 (P431.02)	Analog input 2: Min frequency value (Analog input 2: AI2 freq @ min) -1000.0 ... [0.0] ... 1000.0 Hz	Definition of the setting range for operating mode "MS: Velocity mode". - Direction of rotation according to sign. - The standard setpoint source for operating mode 0x6060 (P301.00) = "MS: Velocity mode [-2]" is selected in 0x2860:001 (P201.01).
0x2637:003 (P431.03)	Analog input 2: Max frequency value (Analog input 2: AI2 freq @ max) Device for 50-Hz mains: -1000.0 ... [50.0] ... 1000.0 Hz Device for 60-Hz mains: -1000.0 ... [60.0] ... 1000.0 Hz	
0x2637:004 (P431.04)	Analog input 2: Min PID value (Analog input 2: AI2 PID @ min) -300.00 ... [0.00] ... 300.00 PID unit	Definition of the setting range for PID control. - The standard setpoint source for the reference value of PID control is selected in 0x2860:002 (P201.02).
0x2637:005 (P431.05)	Analog input 2: Max PID value (Analog input 2: AI2 PID @ max) -300.00 ... [100.00] ... 300.00 PID unit	
0x2637:006 (P431.06)	Analog input 2: Filter time (Analog input 2: AI2 filter time) 0 ... [10] ... 10000 ms	PT1 time constant for low-pass filter - By the use of a low-pass filter, the impacts of noise to an analog signal can be minimised. - For an optimum filter effect, first the noise frequency has to be determined. The time constant then has to be set so that it equals the reciprocal value of the double frequency.

Parameter	Name / value range / [default setting]	Info			
0x2637:007 (P431.07)	Analog input 2: Dead band (Analog input 2: AI2 dead band) 0.0 ... [0.0] ... 100.0 %	Optional setting of a dead band that is placed symmetrically around the frequency zero point. – The value set defines half the width of the dead band in [%]. – Example: Setting 2 % results in a dead band of 4 %. – If the analog input value is within the dead band, the output value for the motor control is set to "0".			
0x2637:008 (P431.08)	Analog input 2: Monitoring threshold (Analog input 2: AI2 monit.level) -100.0 ... [0.0] ... 100.0 %	Monitoring threshold for analog input 2. Trigger threshold for monitoring the analog input. – 100 % $\equiv$ 10 V (with configuration as voltage input) – 100 % $\equiv$ 20 mA (with configuration as current loop)			
0x2637:009 (P431.09)	Analog input 2: Monitoring condition (Analog input 2: AI2 error resp.)	Monitoring condition for analog input 2. Trigger condition for monitoring the analog input. – If the selected condition is met, the "Error of analog input 2 active[82]" trigger is set to TRUE. The trigger can be assigned to a function or a digital output. – If the selected condition is met for at least 500 ms, the error response set in 0x2637:010 (P431.10) takes place. – If the trigger condition is met for at least 500 ms, the response set in subindex 10 is effected.			
	<table border="1"> <tr> <td>0</td> <td>Input value &lt; trigger threshold</td> </tr> <tr> <td>1</td> <td>Input value &gt; trigger threshold</td> </tr> </table>	0	Input value < trigger threshold	1	Input value > trigger threshold
0	Input value < trigger threshold				
1	Input value > trigger threshold				
0x2637:010 (P431.10)	Analog input 2: Error response (Analog input 2: AI2 error resp.) – For further possible settings, see parameter 0x2D45:001 (P310.01).	Error response for analog input 2. – The selected response takes place if the monitoring condition selected in 0x2637:009 (P431.09) is met for at least 500 ms.			
	3 Fault	Associated error code: – 28802   0x7082 - Error of analog input 2			
0x2637:011 (P431.11)	Analog input 2: Min torque value (Analog input 2: Min. torque) -400.0 ... [0.0] ... 400.0 %	Definition of the setting range for operating mode "MS: Torque mode". – 100 % $\equiv$ permissible maximum torque 0x6072 (P326.00) – Direction of rotation according to sign. – The standard setpoint source for operating mode 0x6060 (P301.00) = "MS: Torque mode [-1]" is selected in			
0x2637:012 (P431.12)	Analog input 2: Max torque value (Analog input 2: Max. torque) -400.0 ... [100.0] ... 400.0 %	0x2860:003 (P201.03). ► See chapter "Torque control w/ freq. limit".			

## 12.15 CONFIGURATION OF DIGITAL OUTPUTS

### 12.15.1 RELAY

Setting for the relay.

**i** Relay is not suitable for direct switching of an electromechanical holding brake! Use a corresponding suppressor circuit in case of an inductive or capacitive load!

Parameter	Name / value range / [default setting]	Info	
0x2634:001 (P420.01)	Digital outputs function: Relay (Dig.out.function: Relay function)	Assignment of a trigger to the relay. Trigger = FALSE: X9/NO-COM open and NC-COM closed. Trigger = TRUE: X9/NO-COM closed and NC-COM open.  Notes: – An inversion set in 0x2635:001 (P421.01) is taken into consideration here.	
	0	Not connected	No trigger assigned (trigger is constantly FALSE).
	1	Constant TRUE	Trigger is constantly TRUE.
	11	Digital input 1	State of X3/DI1, taking an inversion set in 0x2632:001 (P411.01) into consideration.
	12	Digital input 2	State of X3/DI2, taking an inversion set in 0x2632:002 (P411.02) into consideration
	13	Digital input 3	State of X3/DI3, taking an inversion set in 0x2632:003 (P411.03) into consideration.
	14	Digital input 4	State of X3/DI4, taking an inversion set in 0x2632:004 (P411.04) into consideration.
	15	Digital input 5	State of X3/DI5, taking an inversion set in 0x2632:005 (P411.05) into consideration.

Parameter	Name / value range / [default setting]	Info
	<b>51 Ready for operation</b>	TRUE if inverter is ready for operation (no error active no STO active and DC-bus voltage ok). Otherwise FALSE.
	52 Operation enabled	TRUE if inverter and start are enabled. Otherwise FALSE.
	53 Stop active	TRUE if inverter is enabled and motor is not started and output frequency = 0.
	54 Quick stop active	TRUE if quick stop is active. Otherwise FALSE.
	55 Inv.dis.safety	Function not available for VLA1.
	56 Error active	TRUE if error is active. Otherwise FALSE.
	57 Error (non-resettable active)	TRUE if non-resettable error is active. Otherwise FALSE.
	58 Device warning active	TRUE if warning is active. Otherwise FALSE. – A warning has no impact on the operating status of the drive. – A warning is reset automatically if the cause has been eliminated.
	59 Device trouble active	TRUE if a fault is active. Otherwise FALSE. – In the event of a fault, the motor is brought to a standstill with the quick stop ramp. The variable speed drive is then disabled. – Exception: In case of a serious fault, the drive is disabled immediately. The motor becomes torqueless (coasts). – The error state will be left automatically if the error condition is not active anymore. – The restart behaviour after trouble can be configured ▶ See chapter "Automatic restart".
	60 Heatsink temperature warning active	TRUE if current heatsink temperature > warning threshold for temperature monitoring. Otherwise FALSE. – Display of the current heatsink temperature in 0x2D84:001 (P117.01). – Setting of the warning threshold in 0x2D84:002.
	66 Flying restart circuit active	TRUE if flying restart circuit active is active. Otherwise FALSE. ▶ See chapter "Flying restart circuit".
	67 DC braking active	TRUE if DC braking is active. Otherwise FALSE. ▶ See chapter "DC braking".
	69 Rotational direction reversed	TRUE if output frequency is negative. Otherwise FALSE.
	70 Frequency threshold exceeded	TRUE if current output frequency > frequency threshold. Otherwise FALSE. – Display of the current output frequency in 0x2DDD (P100.00). – Setting Frequency threshold in 0x4005 (P412.00). ▶ Frequency threshold for "Frequency threshold exceeded" trigger
	71 Actual speed = 0	TRUE if current output frequency = 0 Hz ( $\pm 0.01$ Hz), irrespective of the operating mode. Otherwise FALSE. – Display of the current output frequency in 0x2DDD (P100.00).
	72 Setpoint speed reached	TRUE if frequency setpoint reached. Otherwise FALSE.
	73 PID feedback = setpoint	TRUE if the controlled variable fed back = process controller setpoint ( $\pm$ in 0x404D:003 (P608.03) set hysteresis). Otherwise FALSE. ▶ See chapter "Basic process controller setting".
	74 PID idle state active	TRUE if the variable speed drive is in "PID idle state". Otherwise FALSE. ▶ See chapter "Process controller idle state".
	75 PID MIN alarm active	TRUE if fed back variable (with activated PID control) < MIN alarm threshold. Otherwise FALSE. – Setting of MIN alarm threshold in 0x404D:001 (P608.01). ▶ See chapter "Basic process controller setting".
	76 PID MAX alarm active	TRUE if the fed back variable (with activated PID control) > MAX alarm threshold. Otherwise FALSE. – Setting of MAX alarm threshold in 0x404D:002 (P608.02). ▶ See chapter "Basic process controller setting".
	77 PID MIN-MAX alarm active	TRUE if no PID alarm is active with activated PID control (MIN alarm threshold < fed back variable < MAX alarm threshold). Otherwise FALSE. – Setting of MIN alarm threshold in 0x404D:001 (P608.01). – Setting of MAX alarm threshold in 0x404D:002 (P608.02). ▶ See chapter "Basic process controller setting".
	78 Current limit reached	TRUE if current motor current $\geq$ maximum current. Otherwise FALSE. – Display of the present motor current in 0x2D88 (P104.00). – Setting for the maximum current in 0x6073 (P324.00).
	79 Torque limit reached	TRUE if torque limit has been reached or exceeded. Otherwise FALSE. – Setting "Positive torque limit" in 0x60E0. – Setting "Negative torque limit" in 0x60E1.
	81 Error of analog input 1 active	TRUE if the monitoring of the input signal at the analog input 1 has responded. Otherwise FALSE. This trigger is set as a function of the following settings: – Monitoring threshold 0x2636:008 (P430.08) – Monitoring condition 0x2636:009 (P430.09) The setting of the Error response in 0x2636:010 (P430.10) has no effect on this trigger. ▶ See chapter "Analog input 1".
	82 Error of analog input 2 active	TRUE if the monitoring of the input signal at the analog input 2 has responded. Otherwise FALSE. This trigger is set as a function of the following settings: – Monitoring threshold 0x2637:008 (P431.08) – Monitoring condition 0x2637:009 (P431.09) The setting of the Error response in 0x2637:010 (P431.10) has no effect on this trigger. ▶ See chapter "Analog input 2".
	83 Load loss detected	TRUE if actual motor current < threshold for load loss detection after delay time of the load loss detection has elapsed. Otherwise FALSE. – Display of the present motor current in 0x6078 (P103.00). – Setting Threshold in 0x4006:001 (P710.01). – Setting Deceleration in 0x4006:002 (P710.02). ▶ See chapter "Load loss detection".

Parameter	Name / value range / [default setting]	Info
	100 Sequencer controlled	The control is executed via the sequencer (according to the configuration of the digital outputs for the current segment). ► See chapter "Segment configuration".
	101 Sequence active	Status signal of the "sequencer" function: TRUE if the sequence is running and is currently not suspended. ► See chapter "Sequencer".
	102 Sequence suspended	Status signal of the "sequencer" function. TRUE if the sequence is currently suspended. ► See chapter "Sequencer".
	103 Sequence done	Status signal of the "sequencer" function TRUE if the sequence is completed (final segment has been passed through). ► See chapter "Sequencer".
	104 Local control active	TRUE if local keypad control ("LOC") active. Otherwise FALSE.
	105 Remote control active	TRUE if remote control ("REM") via terminals, etc. active. Otherwise FALSE.
	106 Manual setpoint selection active	TRUE if manual setpoint selection ("MAN") via keypad active. Otherwise FALSE. – Selection of the trigger for the "Activate keypad setpoint" function in 0x2631:016 (P400.16).
	107 Automatic setpoint selection active	TRUE if automatic setpoint selection ("AUTO") via terminals, etc. active. Otherwise FALSE.
	108 Parameter set 1 active	TRUE if parameter set 1 is loaded and active. Otherwise FALSE.
	109 Parameter set 2 active	TRUE if parameter set 2 is loaded and active. Otherwise FALSE.
	110 Parameter set 3 active	TRUE if parameter set 3 is loaded and active. Otherwise FALSE.
	111 Parameter set 4 active	TRUE if parameter set 4 is loaded and active. Otherwise FALSE.
	112 Parameter set load OK	TRUE after any parameter set has been loaded. Otherwise FALSE.
	113 Parameter set load fail	TRUE if any of the parameter sets could not be loaded. Otherwise FALSE.
	115 Release holding brake	Trigger signal for releasing the holding brake (TRUE = release holding brake). Note! If this trigger is assigned to the relay or a digital output, the deceleration times set for the respective output are not effective (are internally set to "0"). Only the deceleration time set in 0x2820:012 (P712.12) for closing the holding brake influences in this case the time-dependent behaviour of the output. ► See chapter "Holding brake control".
	117 Motor phase failure	TRUE if a motor phase failure has been detected. Otherwise FALSE. ► See chapter "Motor phase failure detection".
	118 UPS operation active	Function not available for VLA1.
	155 Both STO channels not active	Function not available for VLA1.
0x2635:001 (P421.01)	Inversion of digital outputs: Relay (DO inversion: Relay inverted)	Relay inversion.
	<b>0 Not inverted</b>	
	<b>1 Inverted</b>	

#### 12.15.2 DIGITAL OUTPUT 1

Settings for digital output 1.

Parameter	Name / value range / [default setting]	Info
0x2634:002 (P420.02)	Digital outputs function: Digital output 1 (Dig.out.function: DO1 function) – For further possible settings, see parameter 0x2634:001 (P420.01).	Assignment of a trigger to digital output 1. Trigger = FALSE: X3/DO1 set to LOW level. Trigger = TRUE: X3/DO1 set to HIGH level.  Notes: – An inversion set in 0x2635:002 (P421.02) is taken into consideration here. The control is executed via the sequencer (according to the configuration of the digital outputs for the current segment). ► See chapter "Segment configuration".
	<b>115 Release holding brake</b>	
	100 Sequencer controlled	
0x2635:002 (P421.02)	Inversion of digital outputs: Digital output 1 (DO inversion: DO1 inversion)	Inversion of digital output 1.
	<b>0 Not inverted</b>	
	<b>1 Inverted</b>	

12.16.1 ANALOG OUTPUT 1

Settings for analog input 1.

Details

The analog output 1 is controlled with the signal selected in 0x2639:002 (P440.02).

The following settings are possible for the analog output:

- Definition of the signal range ①
- Definition of the output range ②

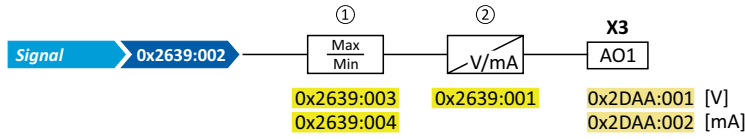

Diagnostic parameters:

- The current output voltage is displayed in 0x2DAA:001 (P112.01).
- The actual output current is displayed in 0x2DAA:002 (P112.02).

Definition of the signal range

The signal range results from the resolution of the selected signal multiplied by the set min and max signal value. Signals outside the signal range are cut off. For examples, see the following table:

Signal 0x2639:002 (P440.02)	Resolution	Min. signal 0x2639:003 (P440.03)	Max. signal 0x2639:004 (P440.04)	Signal range
Output frequency	0.1 Hz	0	1000	0 ... 100.0 Hz
Frequency setpoint	0.1 Hz	0	1000	0 ... 100.0 Hz
Analog input 1	0.1 %	0	1000	0 ... 100.0 %
Analog input 2	0.1 %	0	1000	0 ... 100.0 %
Motor current	0.1 A	0	100	0 ... 10.0 A
Output power	0.001 kW	0	250	0 ... 0.250 kW
Torque actual value	0.1 % *	0	1000	0 ... 100.0 % *

\* 100 % ≙ Motor rated torque 0x6076 (P325.00)

Detailed configuration examples can be found in the following subchapters.

Definition of the output range

The analog output can be configured as voltage or current source. The output range selected in 0x2639:001 (P440.01) then corresponds to the configured signal range.

Configuration examples

Detailed configuration examples can be found in the following subchapters:

- ▶ Example 1: Output voltage 0 ... 10 V output frequency 0 ... 100 Hz
- ▶ Example 2: Output voltage 2 ... 10 V output frequency 30 ... 60 Hz

Parameter	Name / value range / [default setting]	Info
0x2639:001 (P440.01)	Analog output 1: Output range (Analog output 1: AO1 outp. range)	Definition of the output range.
	0   Inhibited	
	1   <b>0 ... 10 VDC</b>	
	2   0 ... 5 VDC	
	3   2 ... 10 VDC	
	4   4 ... 20 mA	
5   0 ... 20 mA		

Parameter	Name / value range / [default setting]	Info
0x2639:002 (P440.02)	Analog output 1: Function (Analog output 1: AO1 function)	Selection of the signal to be shown at analog output 1.
	0 Not active	No output signal.
	1 Output frequency	Actual output frequency (resolution: 0.1 Hz).
	2 Frequency setpoint	Actual frequency setpoint (resolution: 0.1 Hz).
	3 Analog input 1	Input signal of analog input 1 (resolution: 0.1 %).
	4 Analog input 2	Input signal of analog input 2 (resolution: 0.1 %).
	5 Motor current	Actual motor current (resolution: 0.1 A).
	6 Output power	Actual output power (resolution: 0.001 kW).
	7 Torque actual value	Torque actual value (resolution: 0.1 %). – 100 % ≙ permissible maximum torque 0x6072 (P326.00)
	10 Sequencer controlled	Voltage value which has been set for the currently executed sequencer segment (resolution 0.01 V). ► Sequencer
	20 NetWordIN3	Actual value of the NetWordIN3 data word (resolution 0.1 %) Note. This function is not available for VLA1.
	21 NetWordIN4	Actual value of the NetWordIN4 data word (resolution 0.1 %). Note. This function is not available for VLA1.
	201 Internal value	Internal values of the manufacturer.
202 Internal value		
203 Internal value		
204 Internal value		
205 Internal value		
206 Internal value		
0x2639:003 (P440.03)	Analog output 1: Min. signal (Analog output 1: AO1 min. signal) -2147483648 ... [0] ... 2147483647	Definition of the signal value that corresponds to the minimum value at analog output 1. Example: configuration of analog output 1 as a 4 ... 20 mA current loop: output current 4 mA ≙ 0x2639:003.
0x2639:004 (P440.04)	Analog output 1: Max. signal (Analog output 1: AO1 max. signal) -2147483648 ... [1000] ... 2147483647	Definition of the signal value that corresponds to the maximum value at analog output 1. Example: configuration of analog output 1 as a 4 ... 20 mA current loop: output current 20 mA ≙ 0x2639:004.

12.16.1.1 EXAMPLE 1: OUTPUT VOLTAGE 0 ... 10 V OUTPUT FREQUENCY 0 ... 100 HZ

In this configuration a voltage is provided at the analog output proportionately to the current output frequency of the variable speed drive (1 V 10 Hz, resolution 0.1 Hz).

Parameter	Name	Setting for this example
0x2639:001 (P440.01)	Analog output 1: Output range	0 ... 10 VDC [1]
0x2639:002 (P440.02)	Analog output 1: Function	Output frequency [1]
0x2639:003 (P440.03)	Analog output 1: Min. signal	0
0x2639:004 (P440.04)	Analog output 1: Max. signal	1000

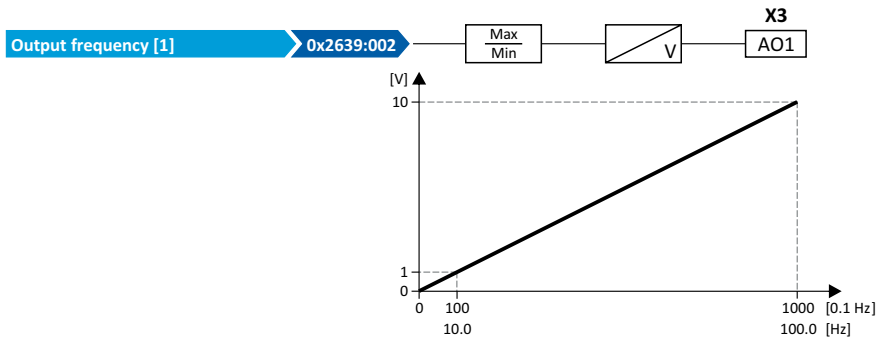

12.16.1.2 EXAMPLE 2: OUTPUT VOLTAGE 2 ... 10 V OUTPUT FREQUENCY 30 ... 60 HZ

In this configuration the output range 2 ... 10 V is used for the output of the output frequency (resolution 0.1 Hz). The example shows how the signals outside the signal range (here: 30 ... 60 Hz) are cut off.

Parameter	Name	Setting for this example
0x2639:001 (P440.01)	Analog output 1: Output range	2 ... 10 VDC [3]
0x2639:002 (P440.02)	Analog output 1: Function	Output frequency [1]
0x2639:003 (P440.03)	Analog output 1: Min. signal	300
0x2639:004 (P440.04)	Analog output 1: Max. signal	600

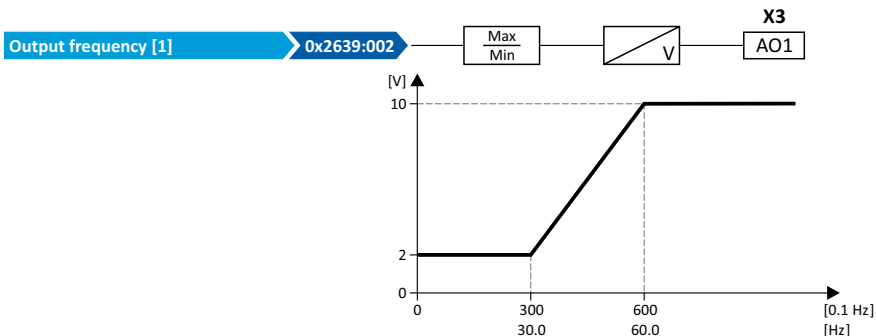



### 13 TECHNICAL DATA

#### 13.1 STANDARDS AND OPERATING CONDITIONS

##### 13.1.1 PROTECTION OF PERSONS AND DEVICE PROTECTION

Enclosure		
IP20	EN 60529	
Type 1	NEMA 250	Protection against contact
Open type		only in UL-approved systems
Insulation resistance		
Overvoltage category III	EN 61800-5-1	0 ... 2000 m a.m.s.l.
Overvoltage category II		above 2000 m a.m.s.l.
Control circuit isolation		
Safe mains isolation by double/reinforced insulation	EN 61800-5-1	
Protective measures against		
Short circuit		
Earth fault		Earth fault strength depends on the operating status
Motor overtemperature		I <sup>2</sup> t monitoring
Overvoltage		
Motor stalling		
Leakage current		
> 3.5 mA AC, > 10 mA DC	EN 61800-5-1	Observe regulations and safety instructions
Starting current		
≤ 3 x rated mains current		

##### 13.1.2 EMC DATA

Actuation on public supply systems		
Implement measures to limit the radio interference to be expected:		The machine or plant manufacturer is responsible for compliance with the requirements for the machine/plant!
< 1 kW: with mains choke	EN 61000-3-2	
> 1 kW at mains current ≤ 16 A: without additional measures		
Mains current > 16 A: with mains choke or mains filter, with dimensioning for rated power. Rsce ≥ 120 is to be met.	EN 61000-3-12	RSCE: short-circuit power ratio at the connection point of the machine/plant to the public network.
Noise emission		
Category C2	EN 61800-3	Type-dependent, for motor cable lengths see rated data.
Noise immunity		
Meets requirement in compliance with	EN 61800-3	

##### 13.1.3 MOTOR CONNECTION

Requirements to the shielded motor cable		
Capacitance per unit length		
C-core-core/C-core-shield < 75/150 pF/m		≤ 2.5 mm <sup>2</sup> / AWG 14
C-core-core/C-core-shield < 150/300 pF/m		≥ 4 mm <sup>2</sup> / AWG 12
Electric strength		
U <sub>0</sub> /U = 0.6/1.0 kV		U <sub>0</sub> = r.m.s. value external conductor to PE
U ≥ 600 V	UL	U = r.m.s. value external conductor/external conductor

### 13.1.4 ENVIRONMENTAL CONDITIONS

Energy efficiency		
Class IE2	EN 50598-2	Reference: Lovato setting (switching frequency 8 kHz variable)
Climate		
1K3 (-25 ... +60 °C)	EN 60721-3-1	Storage
2K3 (-25 ... +70 °C)	EN 60721-3-2	Transport
3K3 (-10 ... +55 °C)	EN 60721-3-3	Operation
		Operation at a switching frequency of 2 or 4 kHz: above +45°C, reduce rated output current by 2.5 %/°C
		Operation at a switching frequency of 8 or 16 kHz: above +40°C, reduce rated output current by 2.5 %/°C
Site altitude		
0 ... 1000 m a.m.s.l.		
1000 ... 4000 m a.m.s.l.		Reduce rated output current by 5 %/1000 m
Pollution		
Degree of pollution 2	EN 61800-5-1	
Vibration resistance		
Transport		
2M2 (sine, shock)	EN 60721-3-2	
Operation		
Amplitude 1 mm	Germanischer Lloyd	5 ... 13.2 Hz
Acceleration resistant up to 0.7 g		13.2 ... 100 Hz
Amplitude 0.075 mm	EN 61800-5-1	10 ... 57 Hz
Acceleration resistant up to 1 g		57 ... 150 Hz

1585 GB 09 18

### 13.1.5 ELECTRICAL SUPPLY CONDITIONS

Permissible mains systems		
TT		Voltage against earth: max. 300 V
TN		
IT		Apply the measures described for IT systems!
		IT systems are not relevant for UL-approved systems

### 13.2 1-PHASE MAINS CONNECTION 230/240 V

#### 13.2.1 RATED DATA

The output currents apply to these operating conditions:

- At a switching frequency of 2 kHz or 4 kHz: Max. ambient temperature 45°C.
- At a switching frequency of 8 kHz or 16 kHz: Max. ambient temperature 40°C.

Power	kW	0.25	0.4	0.75	1.5	2.2
Mains voltage range		1/N/PE AC 170 V ... 264 V, 45 Hz ... 65 Hz				
Rated mains current						
without mains choke	A	4	5.7	10	16.7	22.5
with mains choke	A	3.6	4.8	8.8	13.9	16.9
Output current						
2 kHz	A	-	-	4.2	7	9.6
4 kHz	A	1.7	2.4	4.2	7	9.6
8 kHz	A	1.7	2.4	4.2	7	9.6
16 kHz	A	1.1	1.6	2.8	4.7	6.4
Power loss	W	15	20	33	50	70
Overcurrent cycle 180 s						
Max. output current	A	2.55	3.6	6.3	10.5	14.4
Overload time	s	60	60	60	60	60
Recovery time	s	120	120	120	120	120
Max. output current during the recovery time	A	1.28	1.8	3.15	5.25	7.2
Overcurrent cycle 15 s						
Max. output current	A	3.4	4.8	8.4	14	19.2
Overload time	s	3	3	3	3	3
Recovery time	s	12	12	12	12	12
Max. output current during the recovery time	A	1.28	1.8	3.15	5.25	7.2
Motor cable length						
shielded, without EMC	m	50				
C2 residential area / industrial premises	m	5		20		
Weight	kg	0.75	0.95	1.35		

## 14 APPENDIX

### 14.1 OPERATE AND PARAMETERISE THE VARIABLE SPEED DRIVE WITH KEYPAD

The keypad is an easy means for the local operation, parameterisation and diagnostic of the variable speed drive.



- The keypad is simply connected to the diagnostic interface on the front of the variable speed drive.
- The keypad can also be connected and removed during operation.

#### 14.1.1 KEYPAD OPERATING MODE

After switching on the variable speed drive, the keypad plugged in is in "Operating mode" after a short initialisation phase.

##### 14.1.1.1 KEYPAD STATUS DISPLAY

In the operating mode, the keypad displays information on the status of the variable speed drive.

Keypad display	Display	Meaning
<p>If the variable speed drive is inhibited, the keypad shows "STOP":</p>	<p>① Active control mode:</p>	<p>VEL Speed mode</p> <p>PID Process controller mode</p> <p>TRQ Torque mode</p> <p>JOG Manual mode</p>
<p>If the variable speed drive is enabled, the keypad shows the output frequency of the variable speed drive:</p>	<p>② Active control source:</p>	<p>FLEX Flexible I/O configuration</p> <p>KPD Keypad</p> <p>KPDF Keypad (complete control via keypad including setpoint selection)</p> <p>NET Network (not available for VLA1)</p>
<ul style="list-style-type: none"> <li>- In the process controller mode, instead of the output frequency, the process controller setpoint is displayed.</li> <li>- The display can be configured in 0x2864 (P703.00).</li> <li>- The language for the keypad display is preset to "English". The language can be changed in 0x2863 (P705.00).</li> </ul>	<p>③ Active setpoint source:</p>	<p>AINx Analog input x</p> <p>KPD Keypad</p> <p>NET Network</p> <p>FREQ Digital frequency</p> <p>PRx Preset setpoint x</p> <p>SEGx Segment x</p> <p>MOP Motor potentiometer</p>
	<p>④ Current direction of rotation:</p>	<p>FWD Motor is rotating forwards</p> <p>REV Motor is rotating backwards</p>
	<p>⑤ Lower status line:</p>	<p>LOC Local keypad control active.</p> <p>REM Remote control via terminals, network, etc. active.</p> <p>MAN Manual setpoint selection via keypad active.</p> <p>AUTO Automatic setpoint selection via terminals, network, etc. active.</p> <p>SET Blinking if one parameter setting has been changed but has not been saved in the memory module with mains failure protection. Save settings: Press keypad enter key longer than 3 s.</p>
<p>If an error is pending, the keypad shows the following information:</p>	<p>① Error text</p> <p>② Error type:</p>	<p>F Fault</p> <p>T Trouble</p> <p>W Warning</p>
<ul style="list-style-type: none"> <li>- Faults (F) and trouble (T) are displayed continuously.</li> <li>- Warnings (W) are only displayed every 2 seconds for a short time.</li> </ul>	<p>③ Error code (hexadecimal)</p>	<p>► See chapter "Error codes"</p> <p>► See chapter "Error handling"</p> <p>► See chapter "Error reset with keypad".</p>
		<p>After a disturbance, a restart is possible if the error condition is not active anymore. The keypad shows this by the "Restart Pending" note. The note is displayed in a 1-second interval alternating with the error text.</p> <p>► See chapter "Automatic restart".</p>

### 14.1.1.2 FUNCTION OF KEYPAD KEYS IN OPERATING MODE

In the operating mode, the keypad can be used for local control and for manual setpoint selection.

Function of keypad keys in operating mode			
Key	Actuation	Condition	Action
	Shortly	Local keypad control active. Display "LOC"	Run motor.
	Shortly	Remote control active Display "REM" Display "KSTOP"	Deactivate keypad triggered stop. The motor remains at standstill. Display changes from "KSTOP" to "STOP".
	Shortly	Operating mode	Change to parameterisation mode. ▶ See chapter "Keypad parameterisation mode".
	More than 3 s	None (anytime possible)	Save parameter settings in the user memory.
	Shortly	During operation	Scroll through information in the above status line.
	Shortly	Manual setpoint selection via keypad active. Display "MAN"	Change frequency setpoint.
	Shortly	Operating mode	Activate full keypad control Display "ON?" → Confirm with ↵ Control and setpoint selection can now only be carried out via keypad. Renewed clicking: Exit full keypad control. Display "OFF?" → Confirm with ↵ ▶ See chapter "Keypad - Configuration of R/F and CTRL buttons".
	Shortly	Local keypad control active. Display "LOC"	Reversal of rotation direction (from version 4.1). Display "REV?" → Confirm with ↵ ▶ See chapter "Keypad - Configuration of R/F and CTRL buttons".

### EXAMPLE: CHANGE SETPOINT

If the setpoints are selected manually via keypad, the frequency setpoint can be changed in the operating mode via the arrow keys (even while the motor is running):

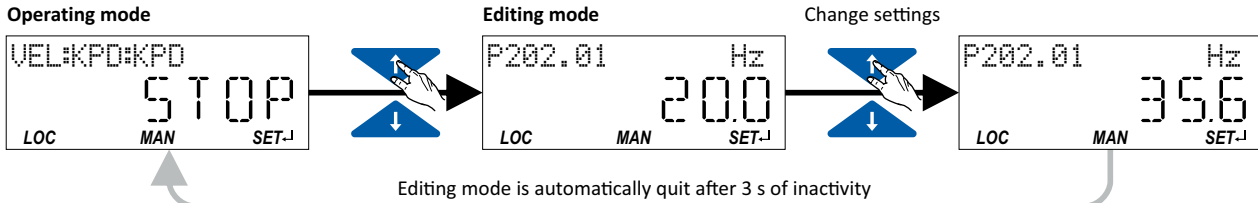

### 14.1.1.3 ERROR RESET WITH KEYPAD

Use the keypad key to reset a resettable error if the error condition no longer exists and no blocking time is active.

– The "Error code table" gives the blocking time (if available) for each error.

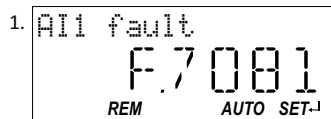

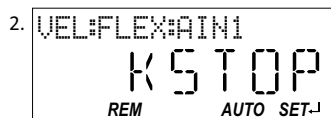

1. Press keypad key.  
The error is reset. The motor remains stopped via keypad (display "KSTOP").
2. In order to cancel the stop via keypad again: Press keypad key.



### 14.1.2 KEYPAD PARAMETERISATION MODE

In the parameterisation mode of the keypad you can have actual values of the variable speed drive displayed for purposes of diagnostics and change settings of the variable speed drive.

Use the  to change from operating mode to the parameterisation mode.

Use the  to return to the operatin mode.

#### 14.1.2.1 PARAMETER GROUPS









In order to provide for quick access, all parameters of the variable speed drive are divided into different groups according to their function.

- Group 0 contains the configurable "Favorites". In the default setting these are the most common parameters for the solution of typical applications. See chapter "Favorites".
- Based on the hundreds digit of the display code (Pxxx) you can quickly see in which group the parameter is to be found on the keypad:

Parameter	Group/name	Description
P1xx	Group 1 - Diagnostics	Diagnostic/display parameters for displaying device-internal process factors, current actual values, and status messages. ▶ See chapter "Diagnostics parameter".
P2xx	Group 2 - Basic setting	Setting of the mains voltage, selection of the control and setpoint source, starting and stopping performance, frequency limits and ramp times. ▶ See chapter "Basic setting".
P3xx	Group 3 - Motor control	Configuration of the motor and motor control ▶ See chapter "Motor control".
P4xx	Group 4 - I/O setting	Function assignment and configuration of the inputs and outputs ▶ See chapter "Flexible I/O configuration".
P5xx	Group 5 - Network setting	Configuration of the network (if available)
P6xx	Group 6 - Process controller	Configuration of the process controller ▶ See chapter "Configuring the process controller".
P7xx	Group 7 - Additional functions	Parameterisable additional functions ▶ See chapter "Additional functions".
P8xx	Group 8 - Sequencer	The "sequencer" function serves to define a programmed sequence of speed setpoints, PID setpoints or torque setpoints for the motor control. Switching to the next setpoint can be executed in a time-based or event-based manner. ▶ See chapter "Sequencer".

#### 14.1.2.2 FUNCTION OF THE KEYPAD KEYS IN THE PARAMETERISATION MODE

In the parameterisation mode, the arrow keys serve to select and change parameters.

Function of the keypad keys in the parameterisation mode			
Key	Actuation	Condition	Action
	Shortly	Local keypad control active. Display "LOC"	Run motor.
		Remote control active. Display "REM" Display "KSTOP"	Deactivate keypad triggered stop. The motor remains at standstill. Display changes from "KSTOP" to "STOP".
	Shortly	No Jog operation	Stop motor. Display "KSTOP"
	Shortly	Parameterisation mode	Navigate to one level below. Group level → Parameter level → [SUB parameter level] → Editing mode
		Editing mode	Exit editing mode and accept new setting.
	More than 3 s	None (anytime possible)	Save parameter settings in the user memory.
	Shortly	Parameterisation mode	Navigate to one level above. [SUB parameter level] → Parameter level → Group level → Operating mode
		Editing mode	Abort: Exit editing mode without accepting new setting.
 	Shortly	Group level/Parameter level	Navigate: Select group/parameter.
		Editing mode	Change parameter setting.
			Without function
			Without function

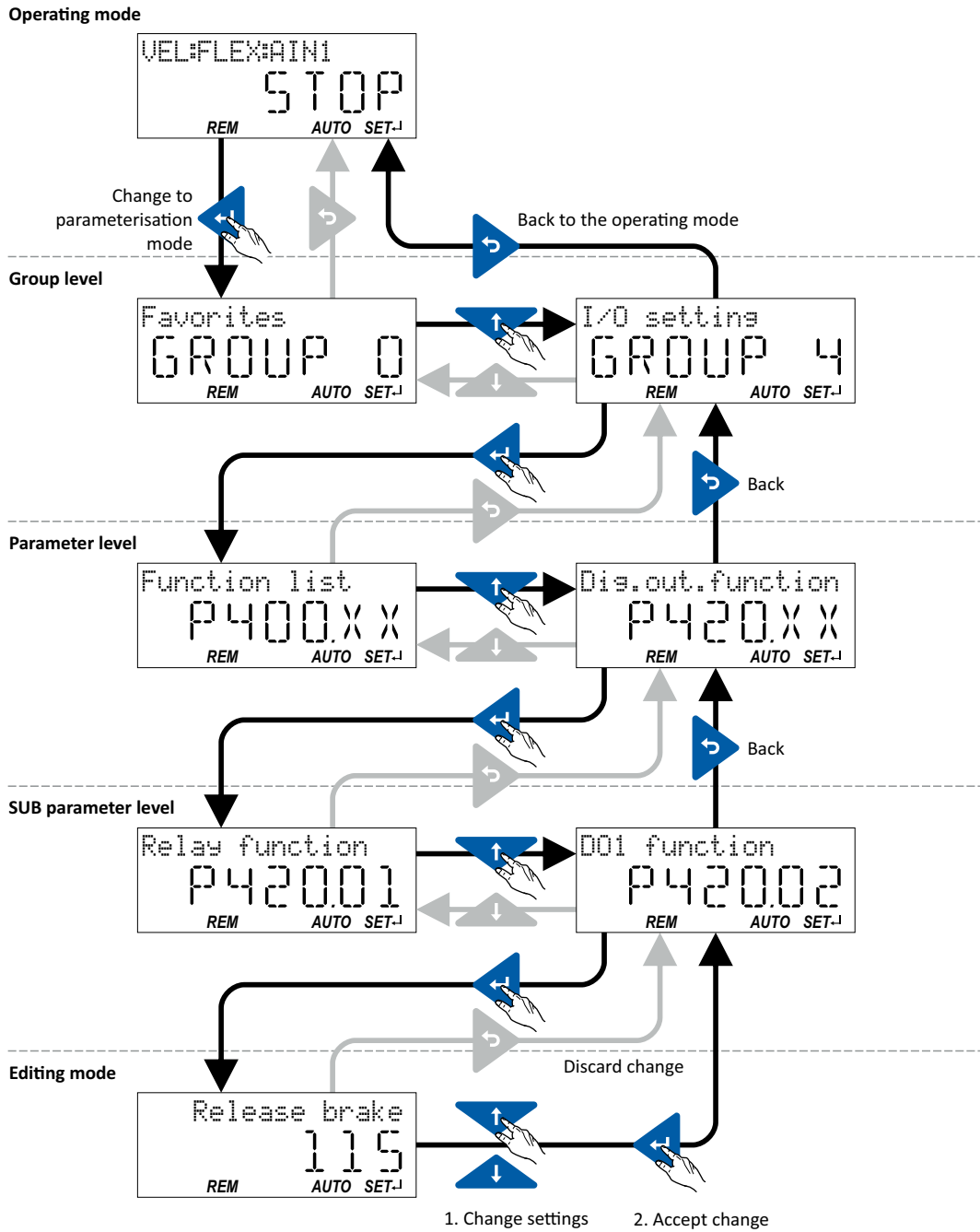

14.1.2.3 SAVE PARAMETER SETTINGS WITH KEYPAD

If one parameter setting has been changed with the keypad but has not been saved in the memory with mains failure protection, the SET display is blinking. In order to save parameter settings in the user memory of the variable speed drive, press the keypad enter key longer than 3 s.

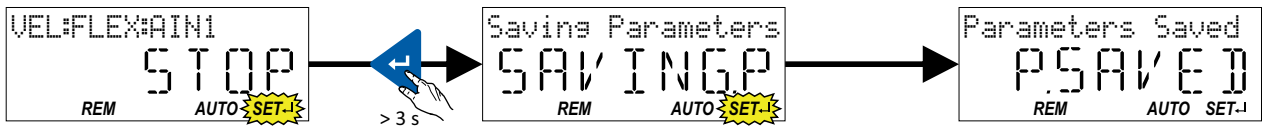

#### 14.1.2.4 DISPLAY OF STATUS WORDS ON KEYPAD

Some diagnostics parameters contain bit-coded status words. Each single bit has a certain meaning.

Display of 16-bit status words on the keypad

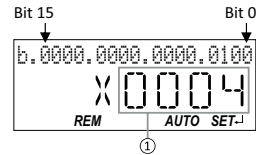

① Hexadecimal value

Display of 32-bit status words on the keypad

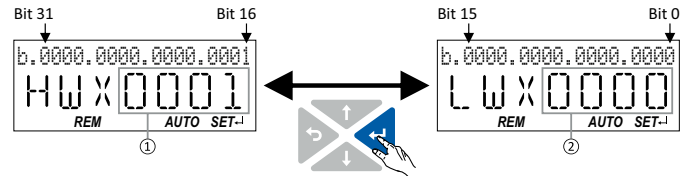

① Hexadecimal value High word (HW)

② Hexadecimal value Low word (LW)

#### 14.2 ERROR CODES

The following table contains the most important error codes of the variable speed drive in ascending order.

– Clicking the error code shows you a detailed description of the error message.

– If the variable speed drive indicates an "internal error" that is not listed here, restart the variable speed drive. If the error persists, make a note of the error code and contact the manufacturer.

Error code	Error message	Error type	Configurable in
9090	0x2382	I*t error	0x2D40:005 (P135.05)
9091	0x2383	I*t warning	-
9095	0x2387	Imax: Clamp responded too ofte	-
12576	0x3120	Mains phase fault	-
12816	0x3210	DC bus overvoltage	-
12817	0x3211	DC bus overvoltage warning	-
12832	0x3220	DC bus undervoltage	-
12833	0x3221	DC bus undervoltage warning	-
12834	0x3222	DC-bus voltage too low for switch-on	-
16912	0x4210	PU: overtemperature fault	-
17024	0x4280	Thermal sensor heatsink error	-
17025	0x4281	Heatsink fan warning	-
17029	0x4285	Power section overtemperature warning	-
24970	0x618A	Internal fan warning	-
25216	0x6280	Trigger/functions connected incorrectly	-
25232	0x6290	Reversal warning	-
25233	25507	Number of maximum permissible faults exceeded	-
0x6291	0x63A3	Power section unknown	-
28800	0x7080	Monitoring of connectio level (Low/High)	-
28801	0x7081	Error of analog input 1	0x2636:010 (P430.10)
28802	0x7082	Error of analog input 2	0x2637:010 (P431.10)
28833	0x70A1	Analog output 1 fault	-
29056	0x7180	Motor overcurrent	0x2D46:002 (P353.02)
30336	0x7680	Memory is full	-
30337	0x7681	No memory	-
30338	0x7682	Memory: invalid user data	-
30340	0x7684	Data not completely saved before switch-off	-
30345	0x7689	Memory: invalid OEM data	-

Error code		Error message	Error type	Configurable in
30352	0x7690	EPM firmware version incompatible	Fault	-
30353	0x7691	EPM data: firmware type incompatible	Fault	-
30354	0x7692	EPM data: new firmware type detected	Fault	-
30355	0x7693	EPM data: PU size incompatible	Fault	-
30356	0x7694	EPM data: new PU size detected	Fault	-
30357	0x7695	Invalid configuration of parameter change-over	Warning	-
30358	0x7696	EPM data: unknown parameter found	Info	-
30359	0x7697	Changed parameters lost	Fault	-
33553	0x8311	Torque limit reached	No response	0x2D67:001 (P329.01)
36992	0x9080	Keypad removed	Fault	-
65286	0xFF06	Motor overspeed	Fault	0x2D44:002 (P350.02)
65289	0xFF09	Motor phase missing	No response	0x2D45:001 (P310.01)
65290	0xFF0A	Phase U motor phase failure	No response	0x2D45:001 (P310.01)
65291	0xFF0B	Motor phase failure phase V	No response	0x2D45:001 (P310.01)
65292	0xFF0C	Motor phase failure phase W	No response	0x2D45:001 (P310.01)
65305	0xFF19	Motor parameter identification error	Fault	-
65335	0xFF37	Automatic start disabled	Fault	-
65366	0xFF56	Maximum motor frequency reached	Warning	-
65413	0xFF85	Keypad full control active	Warning	-



Details regarding the individual error messages

9090 | 0x2382 I\*t error

Keypad display: Ixt error

Cause	Error type/response	Remedy
Device utilisation (I*t) too high by frequent and too long acceleration processes.	Fault – The drive is inhibited immediately. The motor becomes torqueless (coasts). – The error can only be reset after a blocking time of 3 s. – The error type can be configured in 0x2D40:005 (P135.05).	Check drive dimensioning.

Related topics

- See chapter "Device overload monitoring (i\*t)".

9091 | 0x2383 I\*t warning

Keypad display: Ixt warning

Cause	Error type/response	Remedy
Device utilisation (I*t) too high by frequent and too long acceleration processes.	Warning	Check drive dimensioning.

Related topics

- See chapter "Device overload monitoring (i\*t)".

9095 | 0x2387 Imax: Clamp responded too often

Keypad display: Clamp timeout

Cause	Error type/response	Remedy
Maximum current of the axis (display in 0x2DDF:002) has been reached too often in succession.	Fault – The drive is inhibited immediately. The motor becomes torqueless (coasts).	– Select a flatter speed ramp. – Reduce the load. – Set Imax controller more dynamically.

Related topics

- See chapter "Imax controller".

12576 | 0x3120 Mains phase fault

Keypad display: Mains Phase fail

Cause	Error type/response	Remedy
Mains phase failure	Fault – The drive is inhibited immediately. The motor becomes torqueless (coasts).	– Check wiring of the mains connection – Check fuses.

12816 | 0x3210 DC bus overvoltage

Keypad display: DC Bus OV

Cause	Error type/response	Remedy
DC-bus voltage has exceeded the error threshold for overvoltage due to a too high braking energy or a too high mains voltage. The error threshold (display in 0x2540:006 (P208.06)) results from the setting of the rated mains voltage in 0x2540:001 (P208.01).	Fault – The drive is inhibited immediately. The motor becomes torqueless (coasts).	– Reduce dynamic performance of the load profile. – Check mains voltage. – Check setting for the brake energy management.

Related topics

- See chapter "Mains voltage".
- See chapter "Brake energy management".

12817 | 0x3211 DC bus overvoltage warning

Keypad display: Warn.DC Bus OV

Cause	Error type/response	Remedy
DC-bus voltage has exceeded the warning threshold for overvoltage set in 0x2540:005 (P208.05) due to a too high braking energy or a too high mains voltage.	Warning	– Reduce dynamic performance of the load profile. – Check mains voltage. – Check settings for brake energy management.

Related topics

- See chapter "Mains voltage".
- See chapter "Brake energy management".

12832 | 0x3220 DC bus undervoltage

Keypad display: DC Bus UV

Cause	Error type/response	Remedy
DC-bus voltage has fallen below the error threshold for undervoltage. The error threshold (display in 0x2540:003 (P208.03)) results from the setting of the rated mains voltage in 0x2540:001 (P208.01).	Trouble – Check DC-bus voltage. – Check mains setting	– Check mains voltage.

Related topics

- See chapter "Mains voltage".

12833   0x3221 DC bus undervoltage warning		Keypad display: Warn.DC Bus UV
Cause	Error type/response	Remedy
DC-bus voltage has fallen below the warning threshold for undervoltage set in 0x2540:002 (P208.02).	Warning	<ul style="list-style-type: none"> <li>– Check mains voltage.</li> <li>– Check DC-bus voltage.</li> <li>– Check mains setting</li> </ul>

Related topics  
▶ See chapter "Mains voltage".

1585 GB 09 18

12834   0x3222 DC-bus voltage too low for switch-on		Keypad display: DC-bus on-UV
Cause	Error type/response	Remedy
The input voltage is too low to switch on the variable speed drive.	Warning	<ul style="list-style-type: none"> <li>– Check mains voltage.</li> <li>– Check mains setting</li> </ul>

Related topics  
▶ See chapter "Mains voltage".

16912   0x4210 PU: overtemperature fault		Keypad display: PU Overtemp.
Cause	Error type/response	Remedy
<p>The heatsink temperature of the power unit (display in 0x2D84:001 (P117.01)) has exceeded the fixed error threshold (100 °C).</p> <ul style="list-style-type: none"> <li>– Ambient temperature too high.</li> <li>– Fan or ventilation slots are polluted.</li> <li>– Fan is defective</li> </ul>	Fault	<ul style="list-style-type: none"> <li>– Provide for a sufficient cooling of the device.</li> <li>– Clean fan and ventilation slots.</li> <li>– If required, replace fan.</li> <li>– Reduce switching frequency.</li> </ul>

17024   0x4280 Thermal sensor heatsink error		Keypad display: Heatsink sensor
Cause	Error type/response	Remedy
Sensor for the temperature monitoring is defective. The failure of the temperature monitoring function poses the risk of overheating!	Fault	Hardware error: it is necessary to contact the manufacturer, since the device must be replaced.

17025   0x4281 Heatsink fan warning		Keypad display: Heatsink fan
Cause	Error type/response	Remedy
Warning of the heatsink fan.	Warning	Check/replace the heatsink fan.

17029   0x4285 Power section overtemperature warning		Keypad display: Warn.PU Overtemp
Cause	Error type/response	Remedy
<p>The heatsink temperature (display in 0x2D84:001 (P117.01)) has exceeded the warning threshold set in 0x2D84:002.</p> <ul style="list-style-type: none"> <li>– Ambient temperature too high.</li> <li>– Fan or ventilation slots are polluted.</li> <li>– Fan is defective.</li> </ul>	Warning	<ul style="list-style-type: none"> <li>– Provide for a sufficient cooling of the device.</li> <li>– Clean fan and ventilation slots.</li> <li>– If required, replace fan.</li> <li>– Reduce switching frequency.</li> </ul>

Related topics  
▶ See chapter "Heatsink Temperature Monitoring".

20864   0x5180 24-V supply overload		Keypad display: Overload 24V
Cause	Error type/response	Remedy
Output current at the 24V output or at the dig-tal outputs too high.	Warning	Check 24V output and digital outputs for earth fault or overload.

24970   0x618A Internal fan warning		Keypad display: Internal fan
Cause	Error type/response	Remedy
Warning of the internal fan.	Warning	Check/replace internal fan.

25216   0x6280 Trigger/functions connected incorrectly		Keypad display: P400 config err
Cause	Error type/response	Remedy
<p>The assignment directives have not been observed.</p> <ul style="list-style-type: none"> <li>– If the "flexibe I/O configuration" is active as control source, the "Enable inverter" or "Run" function must be connected to a digital input in order that the motor can be stopped again any time.</li> </ul>	Trouble	<p>Check and correct the assignment of the triggers for the functions.</p> <ul style="list-style-type: none"> <li>– With keypad control, the two "Enable inverter" and "Run" functions can also be set to "Constant TRUE [1]" to start the motor.</li> </ul>

Related topics  
▶ See chapter "Start / stop motor".

25232 | 0x6290 Reversal warning

Keypad display: Invert rotation

Cause	Error type/response	Remedy
<ul style="list-style-type: none"> <li>– Negative setpoint selectio with an active limitation of rotation 0x283A (P304.00).</li> <li>– The "Reverse rotationa direction 0x2631:013 (P400.13) function was requested with an active limitation of rotation 0x283A (P304.00).</li> </ul>	Warning The motor is brought to a standstill since a reversal of the rotating direction is not permissible.	<ul style="list-style-type: none"> <li>– Check setpoint selection and trigger.</li> <li>– Check setting in 0x283A (P304.00).</li> </ul>

Related topics

► See chapter "Motor rotating direction".

25233 | 0x6291 Number of maximum permissible faults exceeded

Keypad display: Trouble overflow

Cause	Error type/response	Remedy
The number of permitted restart attempt after a fault set in 0x2839:003 (P760.03) was exceeded. The fault occurred to frequently and could not be reset.	Fault <ul style="list-style-type: none"> <li>– The motor remains at a standstill no automatic restart is executed.</li> </ul>	Check and the eliminate the fault.

Related topics

► See chapter "Automatic restart".

2550 | 0x63A1 CU: load error ID tag

Keypad display: CU ID tag error

Cause	Error type/response	Remedy
Calibration data of the control unit not compatible or faulty.	Fault <ul style="list-style-type: none"> <li>– The drive is inhibited immediatly. The motor becomes torqueless (coasts).</li> <li>– The error can only be reset by mains switching.</li> </ul>	<ul style="list-style-type: none"> <li>– Update firmware of the drive to the most recent version.</li> <li>– If the error persists, the variable speed drive has to be replaced. In this case, please contact the manufacturer.</li> </ul>

25506 | 0x63A2 PU: load error ID tag

Keypad display: PU ID tag error

Cause	Error type/response	Remedy
Calibration data of the power unit not compati ble or faulty.	Fault <ul style="list-style-type: none"> <li>– The drive is inhibited immediatly. The motor becomes torqueless (coasts).</li> <li>– The error can only be reset by mains switching.</li> </ul>	<ul style="list-style-type: none"> <li>– Update firmware of the drive to the most recent version.</li> <li>– If the error persists, the variable speed drive has to be replaced. In this case, please contact the manufacturer.</li> </ul>

25507 | 0x63A3 Power section unknown

Keypad display: PU unknown

Cause	Error type/response	Remedy
The power unit installed is not supported by the software.	Fault <ul style="list-style-type: none"> <li>– The drive is inhibited immediatly. The motor becomes torqueless (coasts)</li> <li>– The error can only be reset by mains switching.</li> </ul>	– Update firmware of the drive to the most recent version.

28800 | 0x7080 Monitoring of connection level (Low/High)

Keypad display: Assertionlevel

Cause	Error type/response	Remedy
The last setting of the connection level differs from the saved setting	Fault	<ol style="list-style-type: none"> <li>1. Check settings .</li> <li>2. Execute device command "Save user data" 0x2022:003 (P700.03).</li> <li>3. Switch drive off and on again.</li> </ol>

28801 | 0x7081 Error of analog input 1

Keypad display: AI1 fault

Cause	Error type/response	Remedy
The monitoring function of the input signal configured for analog input 1 in 0x2636:008 (P430.08) and 0x2636:009 (P430.09) has been triggered.	Fault <ul style="list-style-type: none"> <li>– The error type can be configured in 0x2636:010 (P430.10).</li> </ul>	<ul style="list-style-type: none"> <li>– Check input signal at analog input 1.</li> <li>– Check configuration of the monitoring function.</li> </ul>

Related topics

► See chapter "Analog input 1".

28802 | 0x7082 Error of analog input 2

Keypad display: AI2 fault

Cause	Error type/response	Remedy
The monitoring function of the input signal configured for analog input 2 in 0x2637:008 (P431.08) and 0x2637:009 (P431.09) has been triggered.	Fault <ul style="list-style-type: none"> <li>– The error type can be configured in 0x2637:010 (P431.10).</li> </ul>	<ul style="list-style-type: none"> <li>– Check input signal at analog input 2.</li> <li>– Check configuration of the monitoring function.</li> </ul>

Related topics

► See chapter "Analog input 2".

28833 | 0x70A1 Analog output 1 fault

Keypad display: AO1 fault

Cause	Error type/response	Remedy
Open circuit or short circuit at analog output 1.	Warning	<ul style="list-style-type: none"> <li>– Check wiring of analog output 1.</li> <li>– Check definition of the output range in 0x2639:001 (P440.01).</li> </ul>

Related topics

► See chapter "Analog output 1".

29056 | 0x7180 Motor overcurrent

Keypad display: Mot max current

Cause	Error type/response	Remedy
The motor current has exceeded the warning/ error threshold for the motor current monitoring set in 0x2D46:001 (P353.01).	Fault <ul style="list-style-type: none"> <li>– The error can only be reset after a blocking time of 1 s.</li> <li>– The error type can be configured in 0x2D46:002 (P353.02).</li> </ul>	<ul style="list-style-type: none"> <li>– Check motor load.</li> <li>– Check drive dimensioning.</li> <li>– Check warning/error threshold set in 0x2D46:001 (P353.01).</li> </ul>

Related topics

► See chapter "Overcurrent monitoring".

30336 | 0x7680 Memory is full

Keypad display: EPM full

Cause	Error type/response	Remedy
The memory contains too many parameter settings.	Warning <ul style="list-style-type: none"> <li>– The parameter settings were not saved in the memory .</li> </ul>	Execute "Save user data" 0x2022:003 (P700.03) device command again. This reinitialises the user memory with the current parameter settings. In this way, parameter settings that are no longer required are automatically deleted.

30338 | 0x7682 Memory: invalid user data

Keypad display: EPM invalid data

Cause	Error type/response	Remedy
The user parameter settings in the memory are invalid.	Fault <ul style="list-style-type: none"> <li>– The drive is inhibited immediately. The motor becomes torqueless (coasts).</li> <li>– The user parameter settings are lost.</li> <li>– The default settings were automatically loaded.</li> </ul>	<ol style="list-style-type: none"> <li>1. Execute user parameter settings again.</li> <li>2. Execute device command "Save user data" 0x2022:003 (P700.03).</li> </ol>

30340 | 0x7684 Data not completely saved before switch-off

Keypad display: Save incomplete

Cause	Error type/response	Remedy
Saving of the parameter settings was interrupted by an unexpected disconnection.	Warning <ul style="list-style-type: none"> <li>– The user parameter settings were not fully saved.</li> <li>– At the next switch-on, the data stored are copied to the user memory.</li> </ul>	<ol style="list-style-type: none"> <li>1. Check user parameter settings. (The loaded backup is an older version.)</li> <li>2. If required, repeat the changes made last.</li> <li>3. Execute device command "Save user data" 0x2022:003 (P700.03).</li> </ol>

30345 | 0x7689 Memory: invalid OEM data

Keypad display: OEM data invalid

Cause	Error type/response	Remedy
The OEM memory contains invalid parameter settings or is empty.	Warning <ul style="list-style-type: none"> <li>– The user parameter settings were automatically loaded.</li> </ul>	<ul style="list-style-type: none"> <li>– Execute device command "Save OEM data" 0x2022:006 (P700.06).</li> <li>– Thus, the user parameter settings get lost!</li> </ul>

30352 | 0x7690 EPM firmware version incompatible

Keypad display: EPM-FW incompat.

Cause	Error type/response	Remedy
The parameter settings saved in the memory module are incompatible with the firmware version.	Fault <ul style="list-style-type: none"> <li>– The data have been loaded into the RAM memory, but they are incompatible</li> </ul>	<ol style="list-style-type: none"> <li>1. Execute device command "Load default settings" 0x2022:001 (P700.01).</li> <li>2. Execute "Save user data" 0x2022:003 (P700.03) or "Save OEM data" 0x2022:006 (P700.06) device command.</li> </ol>

30353 | 0x7691 EPM data: firmware type incompatible

Keypad display: EPM: FW incompat.

Cause	Error type/response	Remedy
The parameter settings saved in the memory are incompatible with the firmware type.	Fault <ul style="list-style-type: none"> <li>– The data have been loaded into the RAM memory, but they are incompatible</li> </ul>	<ol style="list-style-type: none"> <li>1. Execute device command "Load default settings" 0x2022:001 (P700.01).</li> <li>2. Execute "Save user data" 0x2022:003 (P700.03) or "Save OEM data" 0x2022:006 (P700.06) device command.</li> </ol>

30354 | 0x7692 EPM data: new firmware type detected

Keypad display: UserCU not match

Cause	Error type/response	Remedy
The parameter settings saved in the memory do not match the variable speed drive hardware.	Fault <ul style="list-style-type: none"> <li>– The data have been loaded into the RAM memory without being modified and they are compatible.</li> <li>– The settings loaded must be accepted by the user (see remedy).</li> </ul>	<ol style="list-style-type: none"> <li>1. Check parameter setting</li> <li>2. Reset error.</li> <li>3. Execute "Save user data" 0x2022:003 (P700.03) or "Save OEM data" 0x2022:006 (P700.06) device command.</li> </ol>

30355   0x7693 EPM data: PU size incompatible		Keypad display: EPM PU size inco
Cause	Error type/response	Remedy
The parameter settings saved in the memory are incompatible with the variable speed drive.	Fault – The data have been loaded into the RAM memory, but they are incompatible.	1. Execute device command "Load default settings" 0x2022:001 (P700.01). 2. Execute "Save user data" 0x2022:003 (P700.03) or "Save OEM data" 0x2022:006 (P700.06) device command.

30356   0x7694 EPM data: new PU size detected		Keypad display: EPM new PU size
Cause	Error type/response	Remedy
The parameter settings saved in the memory comply with a different hardware. Example: Memory of a drive with a power of 0.4 kW is used in a drive with a power of 2.2 kW.	Fault – The data have been loaded into the RAM memory without being modified and they are compatible. – The settings loaded must be accepted by the user (see remedy).	1. Check parameter settings. 2. Reset error. 3. Execute "Save user data" 0x2022:003 (P700.03) or "Save OEM data" 0x2022:006 (P700.06) device command.

30357   0x7695 Invalid configuration of parameter change-over		Keypad display: InvalidChgovrCfg
Cause	Error type/response	Remedy
One or more parameters can no longer be used for the "Parameter change-over" function.	Warning – The parameter change-over function is deactivated.	1. Check error message for parameter change- over in 0x4047:001 (P756.01). 2. Correct the list entry shown in 0x4047:002 (P756.02).

30358   0x7696 EPM data: unknown parameter found		Keypad display: Unkn. Par in EPM
Cause	Error type/response	Remedy
The memory contains parameter settings for one or several parameters that are not known to the variable speed drive.	Info	Execute the "Save user data" 0x2022:003 (P700.03) device command. This reinitialise the user memory with the current parameter settings. In this way, parameter settings that are no longer required are automatically deleted.

30359   0x7697 Changed parameters lost		Keypad display: Parameter loss
Cause	Error type/response	Remedy
A voltage failure has occurred and changed parameter settings that had not been saved yet were available.	Fault – The drive is inhibited immediately. The motor becomes torqueless (coasts). – The parameter settings changed have been lost.	1. Execute user parameter settings again. 2. Execute device command "Save user data" 0x2022:003 (P700.03).

33553   0x8311 Torque limit reached		Keypad display: Torque limit
Cause	Error type/response	Remedy
Motor has reached the torque limit: – 0x60E0: Positive torque limit – 0x60E1: Negative torque limit – 0x6072 (P326.00): Max torque	No response – The error type can be configured in 0x2D67:001 (P329.01).	– Observe load requirements. – Reduce motor load. – Check set torque limits and sources for the torque limits.

Related topics  
► See chapter "Motor torque monitoring".

36992   0x9080 Keypad removed		Keypad display: Keypad removed
Cause	Error type/response	Remedy
The keypad was removed while the keypad control was activated	Fault	– Plug on the keypad again or – activate another control source.

Related topics  
► See chapter "Control source change-over".

65286   0xFF06 Motor overspeed		Keypad display: Motor overspeed
Cause	Error type/response	Remedy
The motor speed has reached the error threshold for overspeed set in 0x2D44:001 (P350.01).	Fault – The error can only be reset after a blocking time of 1 s. – The error type can be configured in 0x2D44:002 (P350.02).	Check application

Related topics  
► See chapter "Motor speed monitoring".

65289   0xFF09 Motor phase missing		Keypad display: Mot.Phase miss.
Cause	Error type/response	Remedy
A failure of several motor phases has been detected.	No response – The error can only be reset after a blocking time of 2 s. – The error type can be configured in 0x2D45:001 (P310.01).	– Check wiring between drive and motor. – In case of a false tripping, adapt the settings for the motor phase failure detection.

Related topics  
► See chapter "Motor phase failure detection".

65290 | 0xFF0A Phase U motor phase failure Keypad display: Phase U failure

Cause	Error type/response	Remedy
A failure of the motor phase U has been detected.	No response – The error can only be reset after a blocking time of 2 s. – The error type can be configured in 0x2D45:001 (P310.01).	– Check wiring between drive and motor. – In case of a false tripping, adapt the settings for the motor phase failure detection.

Related topics

► See chapter "Motor phase failure detection".

65291 | 0xFF0B Motor phase failure phase V Keypad display: Phase V failure

Cause	Error type/response	Remedy
A failure of the motor phase V has been detected.	No response – The error can only be reset after a blocking time of 2 s. – The error type can be configured in 0x2D45:001 (P310.01).	– Check wiring between drive and motor. – In case of a false tripping, adapt the settings for the motor phase failure detection.

Related topics

► See chapter "Motor phase failure detection".

65292 | 0xFF0C Motor phase failure phase W Keypad display: Phase W failure

Cause	Error type/response	Remedy
A failure of the motor phase W has been detected.	No response – The error can only be reset after a blocking time of 2 s. – The error type can be configured in 0x2D45:001 (P310.01).	– Check wiring between drive and motor. – In case of a false tripping, adapt the settings for the motor phase failure detection.

Related topics

► See chapter "Motor phase failure detection".

65305 | 0xFF19 Motor parameter identification error Keypad display: Motor ID fault

Cause	Error type/response	Remedy
During the automatic identification of the motor, an error has occurred.	Fault	– Set motor data so that they comply with the data on the motor nameplate. – Check wiring of the motor.

65335 | 0xFF37 Automatic start disabled Keypad display: Auto start disab

Cause	Error type/response	Remedy
At mains connection, a start command was already available and the automatic start at power-up is set in 0x2838:002 (P203.02) to "Off [0]".	Fault	Deactivate start command and reset error.

65366 | 0xFF56 Maximum motor frequency reached Keypad display: Max. motor freq.

Cause	Error type/response	Remedy
– The maximum motor speed set in 0x6080 (P322.00) is active – The maximum output frequency of the drive has been reached.	Warning	Check application

65413 | 0xFF85 Keypad full control active Keypad display: Keypad full ctrl

Cause	Error type/response	Remedy
If the "Keypad Full Control" control mode is active.	Warning – Both the activity of controlling and the setpoint selection are carried out via the keypad.	Clicking the CTRL keypad key stops the control mode again.

Related topics

► See chapter "Keypad - Configuration of R/F and CTRL buttons".