

ENGINE AND GENERATOR CONTROLLERS



electric

ENERGY AND AUTOMATION

Energy management Engine and generator controllers



- Extensive selection of functions to satisfy all application requirements
- Power supply range 12-24VDC for each single product
- Totally programmable inputs, outputs and alarms
- RS232, RS485, USB, Ethernet communication interface
- Engine control by CANbus
- Setup and supervision software
- Modem control for sending alarm messages and emails.

Engine and generator controllers

	PAGE
Engine protection controllers	8
Stand alone gen-set controllers	9
Automatic mains failure (AMF) gen-set controllers	10
Paralleling controllers for mains-generator and generator-generator	11
Remote and alarm-status relay units	12
Communication devices and accessories	13
Software	14

Dimensions	15
------------------	----





ENGINE PROTECTION CONTROLLERS

- Starting with or without power key switch
- Programmable inputs and outputs
- Front LED indicators for engine alarm conditions and diagnostics.



STAND ALONE GEN-SET CONTROLLERS

- Generator voltage and current control
- Engine protection
- Programmable inputs and outputs
- Programmable alarm properties.



AUTOMATIC MAINS FAILURE (AMF) GEN-SET CONTROLLERS

- Automatic starting of generator and load switching to stand-by emergency source in case of mains failure
- Supervision in "open transition" for contactors, motorised circuit breakers and motorised changeover switches
- Engine protection
- Programmable inputs, outputs and alarms.



PARALLELING CONTROLLERS FOR MAINS-GENERATOR AND GENERATOR-GENERATOR

- Mains-generator "closed transition" synchronising
- Mains-generator load sharing with source peak demand control
- Generator paralleling supervision (island mode with load sharing).



REMOTE UNITS

- Remote viewing and control panels
- Remote annunciator for alarm and status indication
- Digital outputs for alarm and status condition remotely.



COMMUNICATION DEVICES, ACCESSORIES AND SOFTWARE

- Communication interfaces
- Additional digital and analog inputs and outputs
- GPRS-GSM module
- Setup and supervision software
- APP.



	ENGINE PROT. CONTROLLERS	STAND ALONE GEN-SET CONTROLLERS			
	RGK 30	RGK 400SA RGK 420SA	RGK 600SA RGK 601SA	RGK 700SA	RGK 800SA
Generator voltage control	–	L1-L2-L3-N	L1-L2-L3-N	L1-L2-L3-N	L1-L2-L3-N
Current control	–	L1	L1-L2-L3	L1-L2-L3	L1-L2-L3-N
Rated frequency	–	50/60Hz	50/60Hz	50/60Hz	50/60/400Hz
Digital inputs	n° 4	5 neg.+1 pos. (emergency)	4 neg.+1 pos. (emergency)	6 neg.+1 pos. (emergency)	8 neg.+1 pos. (emergency)
Digital outputs	n° 2 (Relay)	5 (SSR)	6 (SSR)	3 (Relay) + 4 (SSR)	3 (Relay)+6 (SSR)+1(SO)
Engine running inputs	“D+” and “AC”	“D+”, Hz	“D+”, Hz	“D+”, “AC”, Hz	“D+”, “AC”, Hz
Ohmic inputs for fuel-pressure-temperature (programmable as digital inputs)	–	1+2 (EXP1040)	●	●	●
Remote supervision	–	–	–	●	●
CANbus interface	–	–	RGK 601SA	●	●
Rated battery voltage	12/24VDC	12/24VDC	12/24VDC	12/24VDC	12/24VDC
Power supply range	9...33VDC	7...33VDC	7...33VDC	7...33VDC	7...33VDC
Mains voltage control	–	–	–	–	–
Rated voltage range	–	100...480VAC	100...480VAC	30...600VAC	30...600VAC
VT programming	–	●	●	●	●
Rated input current	–	5A/1A	5A/1A	5A/1A	5A/1A
TRMS voltage measurement	–	●	●	●	●
TRMS current measurement	–	●	●	●	●
Display	–	LCD with icons and backlight	Graphic backlight LCD, 128x80 pixels	Graphic backlight LCD, 128x80 pixels	Graphic backlight LCD, 128x80 pixels
Engine running magnetic pick-up input	–	●	RGK 600SA	●	●
Engine speed input	“W”	“W” or generator frequency or “Pick-up”	“W” or generator frequency or “Pick-up” (RGK 600SA)	“W” or generator frequency or “Pick-up”	“W” or generator frequency or “Pick-up”
Auxiliary analog input	–	–	–	–	●
I/O expansion	–	1 x EXP1040	RGK RR	RGK RR	3 x EXP... + RGK RR
USB/Optical port on front	–	●	●	●	●
Wi-Fi port on front	–	●	●	●	●
USB port at rear	–	–	–	–	EXP1010
Ethernet port with Web server function	–	–	–	–	EXP1013
GPRS/GSM modem	–	–	–	–	EXP1015
RS232 serial port	–	–	–	●	EXP1011
RS485 serial port	–	–	–	–	●
Event logging	–	–	●	●	●
RTC (Real Time Clock)	–	–	–	–	●
Programmable Inputs/Outputs	–	●	●	●	●
PLC logic function	–	–	–	●	●
Alarms	●	●	●	●	●
User alarms	n° –	2	4	8	8
Alarm property customising	–	●	●	●	●
Texts for alarms, events and parameters	–	●	●	●	●
Multilanguage (type)	n° –	5 (GB - I - F - E - D)	5 (GB - I - F - P - E)①	5 (GB - I - F - P - E)①	5 (GB - I - F - P - E)①
Upload languages	–	–	●	●	●
Load sharing	–	–	–	–	–
Generator paralleling	–	–	–	–	–
Mains-generator synchronising (closed transition)	–	–	–	–	–
IEC front degree of protection	IP40	IP40, IP65 with optional gasket seal②	IP40, IP65 with optional gasket seal	IP65	IP65
Certifications	cULus, EAC	cULus, EAC	cULus, EAC	cULus, EAC	cULus, EAC

① Controller uploading of other multilanguage sets.

② For RGK 400SA only.



	AUTOMATIC MAINS FAILURE (AMF) GEN-SET CONTROLLERS				PARALLELING / LOAD SHARING CONTROLLERS	
	RGK 600 RGK 601 RGK 610	RGK 700	RGK 750	RGK 800	RGK 900	RGK 900SA
Generator voltage control	L1-L2-L3-N	L1-L2-L3-N	L1-L2-L3-N	L1-L2-L3-N	L1-L2-L3-N	L1-L2-L3-N
Current control	L1-L2-L3	L1-L2-L3	L1-L2-L3	L1-L2-L3-N	L1-L2-L3-N	L1-L2-L3-N
Rated frequency	50/60Hz	50/60Hz	50/60Hz	50/60/400Hz	50/60/400Hz	50/60/400Hz
Digital inputs	n° 4 neg.+1 pos. (emergency)	6 neg.+1 pos. (emergency)	8 neg.+1 pos. (emergency)	8 neg.+1 pos. (emergency)	12 neg.+1 pos. (emergency)	12 neg.+1 pos. (emergency)
Digital outputs	n° 6 (SSR)	3 (Relay) + 4 (SSR)	3 (Relay)+6 (SSR) +1(SO)	3 (Relay)+6 (SSR) +1(SO)	3 (Relay)+6 (SSR) +1(SO)	3 (Relay)+6 (SSR) +1(SO)
Engine running inputs	"D+", Hz	"D+", "AC", Hz	"D+", "AC", Hz	"D+", "AC", Hz	"D+", "AC", Hz	"D+", "AC", Hz
Ohmic inputs for fuel-pressure-temperature	●	●	●	●	●	●
Remote supervision	RGK 610	●	●	●	●	●
CANbus interface	RGK 601	●	●	●	●	●
Rated battery voltage	12/24VDC	12/24VDC	12/24VDC	12/24VDC	12/24VDC	12/24VDC
Power supply range	7...33VDC	7...33VDC	7...33VDC	7...33VDC	7...36VDC	7...36VDC
Mains voltage control	L1-L2-L3-N	L1-L2-L3-N	L1-L2-L3-N	L1-L2-L3-N	L1-L2-L3-N	-
Rated voltage range	100...480VAC	30...600VAC	100...480VAC	30...600VAC	30...600VAC	30...600VAC
VT programming	●	●	●	●	●	●
Rated input current	5A/1A	5A/1A	5A/1A	5A/1A	5A/1A	5A/1A
TRMS voltage measurement	●	●	●	●	●	●
TRMS current measurement	●	●	●	●	●	●
Display	Graphic backlight LCD, 128x80 pixels	Graphic backlight LCD, 128x80 pixels	Graphic backlight LCD, 128x80 pixels	Graphic backlight LCD, 128x80 pixels	Graphic backlight LCD, 128x112 pixels	Graphic backlight LCD, 128x112 pixels
Engine running magnetic pick-up input	RGK 600/RGK 610	●	●	●	●	●
Engine speed input	"W"/"Pick-up" (RGK 600/RGK 610) or generator frequency	"W" or generator frequency or "Pick-up"	"W" or generator frequency or "Pick-up"	"W" or generator frequency or "Pick-up"	"W" or generator frequency or "Pick-up"	"W" or generator frequency or "Pick-up"
Auxiliary analog input	-	-	●	●	●	●
I/O expansion	1 x EXP... + RGK RR	RGK RR	2 x EXP... + RGK RR	3 x EXP... + RGK RR	4 x EXP... + RGK RR	4 x EXP... + RGK RR
USB/Optical port on front	●	●	●	●	●	●
Wi-Fi port on front	●	●	●	●	●	●
USB port at rear	EXP1010 (RGK 610)	-	EXP1010	EXP1010	EXP1010	EXP1010
Ethernet port with Web server function	-	-	EXP1013	EXP1013	EXP1013	EXP1013
GPRS/GSM modem	-	-	EXP1015	EXP1015	EXP1015	EXP1015
RS232 serial port	EXP1011 (RGK 610)	●	EXP1011	EXP1011	EXP1011	EXP1011
RS485 serial port	EXP1012 (RGK 610)	-	EXP1012	●	●	●
Event logging	●	●	●	●	●	●
RTC (Real Time Clock)	-	-	●	●	●	●
Programmable Inputs/Outputs	●	●	●	●	●	●
PLC logic function	-	●	●	●	●	●
Alarms	●	●	●	●	●	●
User alarms	n° 4	8	8	8	16	16
Alarm property customising	●	●	●	●	●	●
Texts for alarms, events and parameters	●	●	●	●	●	●
Multilanguage (type)	n° 5 (GB - I - F - P - E) ①	5 (GB - I - F - P - E) ①	5 (GB - I - F - P - E) ①	5 (GB - I - F - P - E) ①	5 (GB - I - F - P - E) ①	5 (GB - I - F - P - E) ①
Upload languages	-	●	●	●	●	●
Load sharing	-	-	-	-	●	●
Generator paralleling	-	-	-	-	-	●
Mains-generator synchronising (closed transition)	-	-	-	-	●	-
IEC front degree of protection	IP40, IP65 with optional gasket seal	IP65	IP65	IP65	IP65	IP65
Certifications	cULus, EAC	cULus, EAC	cULus, EAC	cULus, EAC	cULus, EAC	cULus, EAC

A SUPERIOR CLASS!



CUSTOMISING OPTION

There is a customising slot available on the front to show controller brand name, logo, trademark, part number, brief indication or wording, etc.

PROGRAMMING OPTICAL PORT

The optical port on the panel front, using a standard USB or Wi-Fi point, allows communication with a PC, smartphone and tablet, to carry out programming, diagnostics and data download, without removing power to the electric panel.

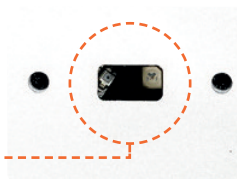

COMPACT SIZE

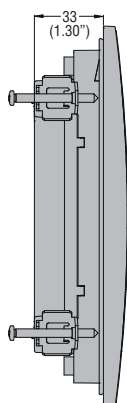

RGK 700
RGK 800
RGK 900

Slim frame profile and reduced total depth simplify installation of the controllers in very compact electric panels.

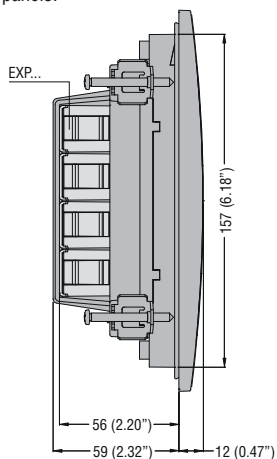

RGK 800
RGK 900

IP65 DEGREE OF PROTECTION

The controller front and the internal display frame seal have been designed to warrant an **IP65** protection degree. This with the **UV film** also allow outdoor installation.



INSTALLATION

The fixing with **metal screws** guarantees excellent adhesion over time.



CABLING AND EXPANSION MODULE FIXING SYSTEM

The controller rear has 4 fitting slots to secure cables connected to the terminals with cable ties, in an orderly way inside the electric panel. In addition, a plastic retainer is supplied as standard to keep the expansion modules in place when installed in applications with strong vibrations.

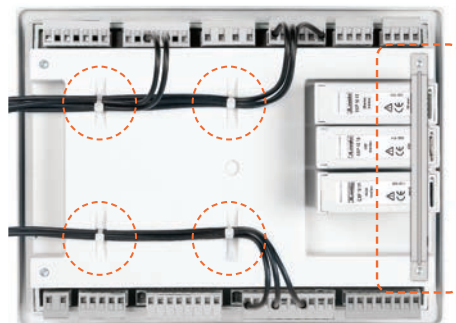

RGK 800
RGK 900

EXPANDABILITY

Basic RGK 750, RGK 800 and RGK 900 controller functions can be easily extended using up to 4 EXP series expansion modules:

- Digital and analog inputs and outputs
- Opto-isolated static outputs
- Relay outputs
- Opto-isolated RS232 interface
- Opto-isolated RS485 interface
- Opto-isolated Ethernet interface with Web server function
- GPRS/GSM modem.



RGK 750 (2 modules)
RGK 800 (3 modules)
RGK 900 (4 modules)



● **EXPANDABILITY**

An extensive selection of modules is available to increase the controller functionality.

● **GPRS/GSM MODEM**

Among the expansion modules, there is a GPRS/GSM modem, automatically configured by genset controller.

● **MAINTENANCE**

Maintenance supervision at programmed intervals.

● **STREAMLINE DESIGN**

The controller has an ergonomic design and, at the same time, particular care has been given to details.

● **GPRS/GSM MODEM**



Once a data-enabled SIM card is inserted, RGK 750 - RGK 800 - RGK 900 controllers can send SMS and **email messages** with alarm and event conditions as well as the latest logged events to a FTP server.

● **OPTO-ISOLATED ETHERNET INTERFACE WITH WEB SERVER FUNCTION**



Web Browsing of the single controller connected in Ethernet by EXP10 13 expansion module.

● **CANBUS COMMUNICATION PORT**

Most models are standard equipped with CAN-J1939 communication port.

● **PLC FUNCTION**

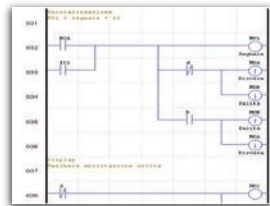

Capability to combine together internal status of controllers with signals incoming from the field to activate outputs and generate alarms.

● **LOAD MANAGEMENT**

There are different methods of controlling the load conditions; each controller has special parameters functions as follows:

- RGK 700 - RGK 750 - RGK 800 types: load shedding and dummy load modes
- RGK 900 types: base-load and peak shaving modes.

● **PARALLELING**

RGK 900 and RGK 900SA controllers can control the switching between the mains and generators without having to switch off the power supply to the load. In addition, they can control the paralleling connection of two or more generators sharing in this way the load on more than one source. The RGK 900MC can control and synchronise mains parallel operation with a power bus composed by a series of generating sets.

● **REMOTE UNITS**

Remote display panels



There are "mirror" display units available to remotely operate as if in front of the generating set.

Remote annunciator



A remote display can view alarm conditions and can be operated for silencing them.

Alarm-state relay unit

The relay unit allows to transmit, on voltage-free contacts, the status and alarms of RGK... controllers.



● **SUPERVISION SOFTWARE**

Synergy is web-based and provides for an easy and efficient way to monitor and control electrical installations as well as field equipment.

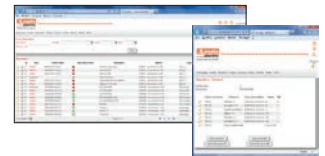

It is a server-multiclient system based on MS SQL RDBMS with web-browser interface. Simultaneous management of different communication channels with independent configuration (protocols, speed rate, RS232, RS485, Ethernet, modem) is possible. Live page view, data log tables, charts and alarms are available.

● **CLOUD SOLUTION**

The supervision software is ready as **Synergy_{Cloud}** solution as well, so that the user does not have to install any package on its own servers.

● **CONFIGURATION AND REMOTE CONTROL SOFTWARE**

Xpress is a parameter configuration and remote monitoring software shared by the entire latest generation of RGK gen-set controllers with communication port.

Engine protection controllers



RGK 30

Order code	Description	Qty per pkg	Wt
		n°	[kg]
RGK 30	12/24VDC, for external start-stop key switch, 96x48mm/3.78x1.89"	1	0.160

General characteristics for RGK 30

OPERATOR INTERFACE

- 2 programming key buttons
- 1 LED indicator for engine status
- 1 LED indicator for glow plug pre-heating
- 5 LED indicators for alarm status
- Remote starting only.

INPUTS/OUTPUTS

- Digital inputs: 3 negative and 1 positive (start/stop by remote key switch)
- Digital outputs: 2 relay (1 programmable).

Certifications and compliance

Certifications obtained: UL Listed, for USA and Canada (cULus-File E93601), as Auxiliary Devices-Generator controllers; EAC.

Compliant with standards: IEC/EN 61010-1, IEC/EN 61000-6-2, EN 55011, UL 508, CSA C22.2 n° 14.

Stand alone gen-set controllers



RGK 400SA



RGK 420SA



RGK 600SA - RGK 601SA



RGK 700SA - RGK 800SA



EXP 10...

new

STAND ALONE APPLICATION

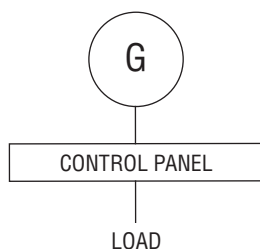

Order code	Description	Qty per pkg	Wt [kg]
		n°	[kg]
RGK 400SA	12/24VDC, icon LCD display, 5 inputs, 5 outputs	1	0.410
RGK 420SA	12/24VDC, icon LCD display, built-in 3 position key switch, 5 inputs, 5 outputs	1	0.430
RGK 600SA	12/24VDC, graphic LCD display, w/Pick-up speed input, 4 inputs, 6 outputs	1	0.540
RGK 601SA	12/24VDC, graphic LCD display, CANbus port, 4 inputs, 6 outputs	1	0.530
RGK 700SA	12/24VDC, graphic LCD display, RS232 serial port, CANbus port, 6 inputs, 7 outputs	1	0.900
RGK 800SA	12/24VDC, graphic LCD display, RS485 serial port, CANbus port. Expandable with EXP... modules, 8 inputs, 10 outputs	1	0.980

Programmable functions and properties

Charact.	RGK 4...SA	RGK 6...SA	RGK 700SA	RGK 800SA
Inputs	5	4	6	8
Relay outputs	–	–	3	3
Protected static outputs	5	6	4	7
Resistive/Digital inputs	1	3	3	4

Order code	Description
ACCESSORIES FOR RGK 4...SA	
EXP80 05	IP65 housing gasket
ACCESSORIES FOR RGK 600SA AND RGK 601SA	
EXP80 01	IP65 housing gasket
EXPANSION MODULES FOR RGK 4...SA AND RGK 800SA Inputs and outputs.	
EXP10 40	2 digital/resistive inputs, 2 static outputs
EXP10 41	2 thermocouple inputs, 2 static outputs
EXP10 42T	6 digital inputs, PCB tropicalized
EXP10 43T	4 digital input and 2 static outputs, PCB tropicalized

EXPANSION MODULES FOR RGK 800SA

Inputs and outputs.

EXP10 00	4 opto-isolated digital inputs
EXP10 01	4 opto-isolated static outputs
EXP10 02	2 digital inputs and 2 static outputs, opto-isolated
EXP10 03	2 relay outputs rated 5A 250VAC
EXP10 04	2 opto-isolated analog inputs 0/4-20mA or PT100 or 0-10V or 0...±5V
EXP10 05	2 opto-isolated analog outputs 0/4-20mA or 0-10V or 0...±5V
EXP10 08	2 opto-isolated digital inputs and 2 relay outputs rated 5A 250VAC

Communications interfaces.

EXP10 10	Opto-isolated USB interface
EXP10 11	Opto-isolated RS232 interface
EXP10 12	Opto-isolated RS485 interface
EXP10 13	Ethernet interface with Web server function
EXP10 15	GPRS/GSM modem

General characteristics for RGK 400SA - RGK 420SA

- Key with 3 positions (OFF, local start, remote start), removable in OFF and remote start position (for RGK 420SA)
- Power supply: 7...33VDC
- VAC inputs: Generator L1-L2-L3-N
- Single, two and three phase voltage control
- Rated measurement voltage range: 100...480VLL (3PH+N)
- Programmable VT ratio
- Frequency measurement range: 45...65Hz
- Current input: 1PH, /5A or /1A
- Display: LCD with icons (52x35mm/2.05x1.38")
- Programming port: IR with support of CX01 (USB) and CX02 (Wi-Fi) dongles
- NFC technology for parameter setup
- Powersave mode
- Inputs: 5 negative + 1 positive for emergency
- Outputs: 5 positive, 2A, protected
- Common pin dedicated to EV and START outputs to be used with emergency push button
- Engine running detection: "D+", Hz
- Engine speed inputs: "W" or Magnetic "Pick-up"
- 1 analog ohmic input for oil pressure, engine temperature or fuel level control
- Alarm and parameter text in 5 languages
- Customisable alarm text (2 alarms)
- Operating temperature: -30...+60°C
- Parameter configuration by NFC technology with **NFC** app
- Compatible with **Synergy**, **Synergy_{com}** and **Xpress** software.

General characteristics for

RGK 600SA - RGK 601SA - RGK 700SA - RGK 800SA

- Power supply: 7...33VDC
- VAC inputs: Generator L1-L2-L3-N
- Single, two and three phase voltage control
- Rated measurement voltage range:
 - 100...480VAC for RGK 600SA and RGK 601SA
 - 30...600VAC for RGK 700SA and RGK 800SA
- Programmable VT ratio
- Frequency measurement range: 45...65Hz
- Current input: 3PH, /5A or /1A
- Graphic LCD: 128x80 pixels with backlight
- Programming port: IR with support of CX01 (USB) and CX02 (Wi-Fi) dongles
- Common pin dedicated to EV and START outputs to be used with emergency push button
- Engine running detection: "D+", Hz
- Engine speed inputs: "W" or Magnetic "Pick-up" (RGK 601SA excluded)
- 1 CANbus-J1939 port (RGK 600SA excluded)
- 3 analog ohmic inputs for oil pressure, engine temperature and fuel level control
- 1 built-in alarm remote port
- Non-volatile memory for event storage
- Alarm, event and parameter text in 5 languages
- Customisable alarm text (8 alarms)
- Operating temperature: -30...+70°C
- Modbus-RTU and Modbus-ASCII protocols
- Compatible with **Synergy**, **Synergy_{com}** and **Xpress** software.

For RGK 700SA – RGK 800SA only

- PLC logic for inputs, outputs and internal status
- 1 communication port: RS232 for RGK 700SA; RS485 for RGK 800SA
- Degree of protection: IEC IP65 on front; suitable for use with UL/CSA Type 4X outdoor enclosure installation.

For RGK 800SA only

- Neutral current measurement range: 0.050...6A or 0.050...1.2A
- 400Hz frequency support
- 1 programmable analog input
- Modbus-TCP communication protocol
- Current leakage control towards earth/ground
- Clock-calendar (RTC)

Certification and compliance

Certifications obtained: UL Listed, for USA and Canada (cULus - File E93601), as Auxiliary Devices - Generator controllers; EAC. Compliant with standards: IEC/EN 61010-1, IEC/EN 61000-6-2, IEC/EN 61000-6-3, UL 508, CSA C22.2 n° 14.

Automatic mains failure (AMF) gen-set controllers



RGK 600 - RGK 601 - RGK 610



RGK 700 - RGK 800



RGK 750



EXP 10...

new

new

AMF (AUTOMATIC MAINS FAILURE) APPLICATION

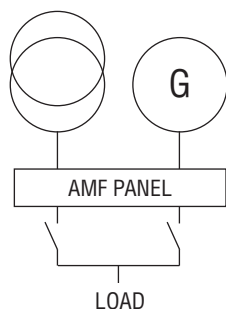

Order code	Description	Qty per pkg	Wt [kg]
RGK 600	12/24VDC, graphic LCD display, w/Pick-up speed input, 4 inputs, 6 outputs	1	0.540
RGK 601	12/24VDC, graphic LCD display, CANbus port, 4 inputs, 6 outputs	1	0.540
RGK 610	12/24VDC, graphic LCD display, w/Pick-up speed input, 4 inputs, 6 outputs, expandable with EXP... modules	1	0.600
RGK 700	12/24VDC, graphic LCD display, RS232 serial port, CANbus port, 6 inputs, 7 outputs	1	0.880
RGK 750	12/24VDC, graphic LCD display, CANbus port, 8 inputs, 10 outputs expandable with EXP... modules	1	0.960
RGK 800	12/24VDC, graphic LCD display, RS485 serial port, CANbus port, 8 inputs, 10 outputs, expandable with EXP... modules,	1	0.960

Programmable functions and properties

Characteristic	RGK 600 RGK 601 RGK 610	RGK 700	RGK 750	RGK 800
Inputs	4	6	8	8
Relay outputs	–	3	3	3
Protected static outputs	6	4	7	7
Resistive/ Digital inputs	3	3	3	4

Order code	Description
ACCESSORY FOR RGK 600, RGK 601 AND RGK 610	
EXP80 01	IP65 housing gasket
EXPANSION MODULES FOR RGK 610, RGK 750 AND RGK 800 Communications interfaces.	
EXP10 10	Opto-isolated USB interface
EXP10 11	Opto-isolated RS232 interface
EXP10 12	Opto-isolated RS485 interface
Inputs and outputs.	
EXP10 42T	6 digital inputs, PCB tropicalized
EXP10 43T	4 digital input and 2 static outputs, PCB tropicalized
EXPANSION MODULES FOR RGK 800 Inputs and outputs.	
EXP10 00	4 opto-isolated digital inputs
EXP10 01	4 opto-isolated static outputs
EXP10 02	2 digital inputs and 2 static outputs, opto-isolated
EXP10 03	2 relay outputs rated 5A 250VAC
EXP10 04	2 opto-isolated analog inputs 0/4-20mA or PT100 or 0-10V or 0...±5V
EXP10 05	2 opto-isolated analog outputs 0/4-20mA or 0-10V or 0...±5V
EXP10 08	2 opto-isolated digital inputs and 2 relay outputs rated 5A 250VAC
EXP10 40	2 digital/resistive inputs, 2 static outputs
EXP10 41	2 thermocouple inputs, 2 static outputs
Communications interfaces.	
EXP10 13	Ethernet interface with Web server function
EXP10 15	GPRS/GSM modem

General characteristics for RGK 600 - RGK 601 - RGK 610 - RGK 700 - RGK 750 - RGK 800

- Power supply: 7...33VDC
- VAC inputs: Mains and generator L1-L2-L3-N
- Voltage control for one, two and three phase systems with or without neutral
- Rated measurement voltage:
 - 480VAC for RGK 600, RGK 601, RGK 610 and RGK 750
 - 600VAC for RGK 700 and RGK 800
- Rated measurement voltage range:
 - 100...480VAC for RGK 600, RGK 601, RGK 610 and RGK 750
 - 30...600VAC for RGK 700 and RGK 800
- Frequency measurement range: 45-65Hz
- Programmable VT ratio
- Current measurement range (3 PH): 0.050...6A or 0.050...1.2A
- Graphic LCD: 128x80 pixels with backlight
- 1 USB/optical and Wi-Fi port on front for programming
- Engine running detection: “D+”, generator voltage and frequency
- Engine speed inputs: “W” or Magnetic “Pick-up” (RGK 601 excluded)
- 1 CANbus-J1939 port (RGK 600 and RGK 610 excluded)
- 3 analog ohmic inputs for oil pressure, engine temperature and fuel level control
- 1 built-in alarm remote port
- Non-volatile memory for event storage
- Alarm, event and parameter text in 5 languages
- Alarm text customisable (8 alarms)
- Event log
- Modbus-RTU and Modbus-ASCII communication protocols (RGK 600 and RGK 601 excluded)
- Compatible with Synergy, Synergy and Xpress software
- 1 slot for EXP modules for RGK 610
- 2 slots for EXP modules for RGK 750
- 3 slots for EXP modules for RGK 800.

For RGK 700 - RGK 750 - RGK 800 only

- PLC logic for inputs, outputs and internal status
- Degree of protection: IEC IP65 on front.

For RGK 700 - RGK 800 only

- 1 communication port: RS232 for RGK 700; RS485 for RGK 800
- Degree of protection: IEC IP65 on front; suitable for use with UL/CSA Type 4X outdoor enclosure installation.

For RGK 800 only

- Neutral current measurement range: 0.050...6A or 0.050...1.2A
- 400Hz frequency support
- 1 programmable analog input
- Modbus-TCP communication protocol
- Current leakage control towards earth/ground
- Clock-calendar (RTC).

Certifications and compliance

Certifications obtained: UL Listed, for USA and Canada (cULus - File E93601), as Auxiliary Devices - Generator controllers except for RGK 750; EAC (except for RGK 750). Compliant with standards: IEC/EN 61010-1, IEC/EN 61000-6-2, IEC/EN 61000-6-3, UL 508, CSA C22.2 n° 14.

Paralleling controllers for mains-generator and generator-generator



RGK 900SA - RGK 900

Order code	Description	Qty per pkg	Wt [kg]
		n°	[kg]

Stand-alone controller.

RGK 900SA	Paralleling control among generating sets. 12/24VDC, graphic LCD, RS485 port and USB/optical and Wi-Fi point programming port on front. Expandable with EXP... modules	1	1.040
------------------	--	---	-------

AMF (Automatic Mains Failure) controller.

RGK 900	Mains-generator paralleling control. 12/24VDC, graphic LCD, with RS485 port, USB/optical and Wi-Fi point programming port on front. Expandable with EXP... modules	1	1.040
----------------	--	---	-------

Mains-ATS (Automatic Transfer Switching) controller.

RGK 900MC	Control of mains, automatic transfer switching (ATS), and paralleling on multiple generators controlled by RGK 900SA. 12/24VDC, graphic LCD, with RS485 port and USB/optical and Wi-Fi point programming port. Expandable with EXP... modules	1	1.040
------------------	---	---	-------

Order code	Description
------------	-------------

EXPANSION MODULES FOR RGK 900...

Inputs and outputs.

EXP10 00	4 opto-isolated digital inputs
EXP10 01	4 opto-isolated static outputs
EXP10 02	2 digital inputs and 2 static outputs, opto-isolated
EXP10 03	2 relay outputs rated 5A 250VAC
EXP10 04	2 opto-isolated analog inputs 0/4-20mA or PT100 or 0-10V or 0...±5V
EXP10 05	2 opto-isolated static outputs 0/4-20mA or 0-10V or 0...±5V
EXP10 08	2 opto-isolated digital inputs and 2 relay outputs rated 5A 250VAC
EXP10 40	2 digital/resistive inputs, 2 static outputs
EXP10 41	2 thermocouple inputs, 2 static outputs

Inputs and outputs.

EXP10 42T	6 digital inputs, PCB tropicalized
EXP10 43T	4 digital input and 2 static outputs, PCB tropicalized

Communications interfaces.

EXP10 10	Opto-isolated USB interface
EXP10 11	Opto-isolated RS232 interface
EXP10 12	Opto-isolated RS485 interface
EXP10 13	Ethernet interface with web server function
EXP10 15	GPRS/GSM modem

General characteristics

- Power supply: 7...36VDC
- VAC inputs: Mains L1-L2-L3-N for RGK 900 only
- VAC inputs: Generator L1-L2-L3-N
- Voltage measurement rated value: 600VAC (UL/CSA)
- Voltage measurement range: 30-720VAC
- Frequency measurement range: 45...65Hz or 360...440Hz
- Programmable VT ratio
- Current measurement input (3 PH+N): 0.05-6A or 0.05...1.2A
- Fourth CT for neutral measurement or earth/ground leakage detection
- Graphic LCD, 128x112 pixels with backlight
- 13 digital inputs
- 3 relay outputs rated 8A 250VAC
- 6 static outputs rated 2A, protected
- 1 static output 50mA
- Engine running detection: "D+" generator voltage and frequency
- 1 engine speed input: "W" or "Magnetic Pick-up"
- 3 analog ohmic inputs for oil pressure, engine temperature and fuel level control
- 1 programmable analog input
- 2 analog outputs for engine speed control (governor) / voltage regulator (AVR)
- Alarm-event-parameter text in 5 languages (Web upload)
- Alarm text customisable (16 alarms)
- Event log
- Modbus-RTU, Modbus-ASCII and Modbus-TCP communication protocols
- Boolean logic for inputs, outputs and internal status
- Compatible with Synergy, Synergy_{eco} and Xpress software
- Degree of protection: IEC IP65 on front; suitable for use with UL/CSA Type 4X outdoor enclosure installation
- Built-in buzzer
- Multi-level passwords
- Sleep function (power saving mode)
- Synchronising and load sharing.

MAIN FUNCTIONS

- Menus for quick selection of rated parameter settings
- "Autocall" function for automatic sending of emails and/or SMS at predefined events/alarms
- Mains (for RGK 900 only) / Generator controls: Phase sequence, phase loss, max and min voltage and frequency, voltage asymmetry
- Programmable maintenance at various intervals
- Current leakage control towards earth/ground
- Mains-generator synchronising (ATS closed transition)
- Mains in base-load with generator in peak shaving
- Paralleling supervision of generators (island mode)
- Generating set start scheduling.

Certifications and compliance

Certifications obtained: UL Listed for USA and Canada (cULus - File E93601), as Auxiliary Devices, Generator controllers; EAC.

Compliant with standards: IEC/EN 61010-1, IEC/EN 61000-6-2, IEC/EN 61000-6-3, UL 508, CSA C22.2 n° 14.



EXP 10...

new

MAINS-GENERATOR PARALLELING	ISLAND MODE	ATS AND PARALLELING OF MAINS WITH MULTIPLE GENSETS
<p>RGK 900 is designed for mains-generator synchronising applications, such as:</p> <ol style="list-style-type: none"> Single generator in maintained parallel with the mains in "base-load" mode (generator power supplied at a steady rate) Single generator in maintained parallel with the mains, in peak-shaving mode (import-export – mains power is limited to constant value and load peaks during heavy demand for power are supplied by generator) Single generator in AMF with temporary parallel with the mains (for emergency, with AMF in closed transition). 	<p>RGK 900SA is designed for applications with load sharing on an isolated bus, without mains:</p> <ol style="list-style-type: none"> Parallel among generators working together in island mode on power bus with load shared among them Generators connected together to maintain the power reserve (total power available minus load power) within a preset range, switching on and off generators according to a priority level. 	<p>Combination of RGK 900SA and RGK 900MC units is designed for load govern controls with multiple generators in parallel on power bus and mains. In these circumstances, the RGK 900MC unit controls, in base-load or peak-shaving mode, the mains and power bus composed by multiple generators, each controlled by an RGK 900SA.</p>

Remote units



RGK 800RD



RGK RA

Alarm-status relay unit



RGK RR

Order code	Description	Qty per pkg	Wt
		n°	[kg]
RGK 800RD SA	Remote display panel for RGK 800SA, 12/24VDC, IP65 protection degree	1	0.820
RGK 800RD	Remote display panel for RGK 800, 12/24VDC, IP65 protection degree	1	0.820
RGK 900RD SA	Remote display panel for RGK 900SA, 12/24VDC, IP65 protection degree	1	0.980
RGK 900RD	Remote display panel for RGK 900, 12/24VDC, IP65 protection degree	1	0.980
RGK RA	Remote display unit for RGK 7..., RGK 8..., RGK 9..., graphic LCD, touch screen 128x112 pixels, IP54 protection	1	0.360

Order code	Description	Qty per pkg	Wt
		n°	[kg]
RGK RR	Alarms-status relay unit 12/24VDC, 12 relay outputs, pulse input, CANbus communication port	1	0.420

Remote display panel RGK...RD characteristics

For remote controller supervision and viewing, the user operates the remote display panel as if directly in front of the generating set.

- 12/24VDC battery power supply
- Graphic LCD with backlight:
 - 128x80 pixels for RGK 800...
 - 128x112 pixels for RGK 900...
- 13 function and setting keys
- 10 Indication LEDs for operating modes and status
- Built-in buzzer
- 4 digital inputs
- 2 digital outputs
- Conductor cross section: 0.2...2.5mm² (24...12 AWG; 18...12 AWG per UL/CSA)
- Tightening torque: 0.56Nm (4.5lbin)
- Front degree of protection: IEC IP65; UL/CSA Type 4X outdoor enclosure installation
- Serial interface ports: opto-isolated RS485 (RGK...RD); CANbus-J1979 (RGK...SA).

Remote display unit RGK RA characteristics

Alarm conditions can be viewed on the remote display and alarm silencing can also be activated.

- Dual 100-240VAC / 12-24VDC power supply
- Touch screen 120x112 pixel backlight graphic LCD
- Built-in buzzer
- Static (SSR) output for global alarm signalling
- Opto-isolated RS485 interface port
- Conductor cross section: 0.2...2.5mm² (24...12 AWG; 18...12 AWG per UL/CSA)
- Tightening torque: 0.56Nm (4.5lbin)
- Front degree of protection: IEC IP54; UL Type 1.

Alarm-status relay unit characteristics

External relay expansion unit for alarm and status remoting.

Fixing on 35mm DIN rail (IEC/EN 60715).

Communication with RGK... controllers by CANbus or pulse inputs:

- 12 relay outputs of which 5 with changeover (SPDT) contact rated 5A 250VAC / B300 and 7 N/O (SPST) contact rated 2.5A 250VAC / C300
- 12/24VDC power supply
- Up to 2 RGK RR units can be connected in cascade for a total of 24 relays
- Maximum installation distance from the RGK 6... and RGK 700... RGK 900 controllers:
 - CANbus: 30m/33yd (high speed)
 - Inputs/Outputs: 1,000m/1,094yd (low speed)
- Conductor cross section: 0.2...2.5mm² (24...12 AWG)
- Tightening torque: 0.56 Nm/4.5lbin.

Certifications and compliance

Certifications obtained: UL Listed, for USA and Canada (cULus – File E93601), as Auxiliary Devices, Generator controllers remote and relay units; EAC.

Comply with standards: IEC/EN 61010-1, IEC/EN 61000-6-2, IEC 61000-6-3, UL508, CSA C22.2 n° 14.

For wiring schemes and technical characteristics, refer to technical instructions in Downloads of local or global website or consult Technical support; see contact details on inside front cover.

Communication devices for RGK 4... - RGK 6... - RGK 7... - RGK 8... - RGK 9...



CX 01



CX 02



CX 03

Order code	Description	Qty per pkg	Wt
		n°	[kg]
CX 01	USB/optical dongle with PC↔-controller connecting cable for programming, data download, diagnostics and firmware upgrade	1	0.090
CX 02	Wi-Fi dongle for PC ↔ controller programming, data download, diagnostics, project upload/download and controller cloning	1	0.090
CX 03	GSM/GPRS penta-band antenna (850/900/1800/1900/2100MHz) for EXP10 15 expansion module for RGK 800... - RGK 900...	1	0.090

General characteristics

Communication and connection devices for generator set controllers RGK 4... - RGK 6... - RGK 7... - RGK 8... - RGK 9... for personal computers, smartphones, tablets, modems, bus drives.

CX 01

The USB/optical connector, complete with cable, allows to connect RGK 4... - RGK 6... - RGK 7... - RGK 8... - RGK 9... controllers to a PC without having to disconnect the power supply from the electric panel and to carry out parameter programming, data and event download, diagnostics and firmware upgrade. The PC identifies the connection as a standard USB.

CX 02

By Wi-Fi connection, RGK 4... - RGK 6... - RGK 7... - RGK 8... - RGK 9... controllers can be viewed by PC, smartphone and tablet with no need for cabling and to carry out parameter programming, data and event download, diagnostics project upload/download and controller cloning.

CX 03

Antenna compatible with the major part of worldwide mobile networks thanks to the available frequencies at 850/900/1800/1900/2100MHz. IP67 IEC protection degree. Fixing by Ø10mm/0.39" drilling. Cable length 2.5m/7.23yd.

For wiring schemes and technical characteristics, refer to technical instructions in Downloads of local or global website or consult Technical support; see contact details on inside front cover.

Accessories



51 C4



EXC CON 01



EXC M3G 01

Order code	Description	Qty per pkg	Wt
		n°	[kg]
Connecting cables.			
51 C2	For PC ↔ controller, 1.8m/2yd long	1	0.090
51 C3	For PC ↔ GSM modem 1.8/2yd long	1	0.210
51 C4	For PC ↔ RS232/RS485, converter drive, 1.8m/2yd long	1	0.147
Converters.			
EXC CON 01	RS485/ Ethernet converter, 12...48VDC, including DIN rail fixing kit	1	0.400
Gateway.			
EXC M3G 01	RS485 Gateway/3G modem, 9.5...27VAC/9.5...35VDC, including antenna (with 2.5m cable) and programming cable	1	0.340
For RGK 600..., RGK 601... and RGK 610 controllers.			
EXP80 01	IP65 144mm/5.67" housing gasket		
For RGK 4...SA.			
EXP80 05	IP65 110mm/4.33" housing gasket		

① RS232/RS485 opto-isolated converter drive, 38,400 Baud rate maximum, automatic or manual TRANSMIT line supervision, 220...240VAC ±10% (110...120VAC supply on request).

Synergy Supervision and Energy management software

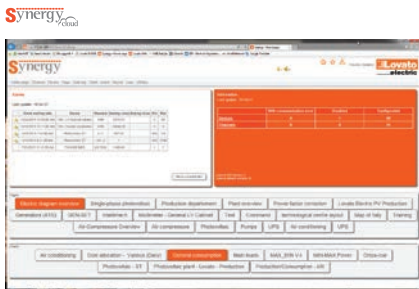
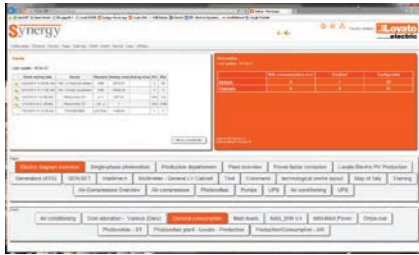

Xpress Parameter configuration and remote control software



Sam1 APP

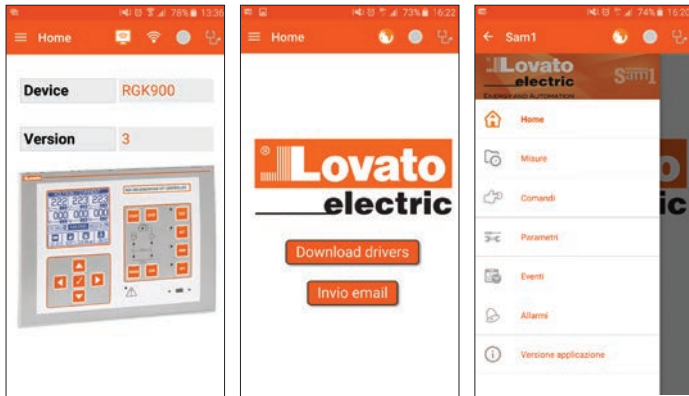

NFC APP



Supervision and Energy management software

The **Synergy** and **Synergy_{cloud}** softwares provides for the remote control and supervision of the RGK... controllers.

Its structure and applications are based on MS SQL relational database management system. Consulting is made through popular programs for Internet browsing available across different platforms and operating systems.

It is a highly versatile system, simultaneously accessible to a large number of users/workstations via intranets, VPN or Internet.

Parameter configuration and remote control software

The **Xpress** is a parameter configuration and remote monitoring software shared by the entire latest generation of RGK gen-set controllers with communication port. It can be installed in the Windows® environment and connect individually (one node at a time) to the RGK gen-set controller connected to the network.

- Supports connection via CX01 (USB) or CX02 (Wi-Fi) dongle, USB, RS232, RS485, Ethernet and modem
- Product configuration:
 - Parameter setting
 - Project file management
- Product firmware upgrade (via CX01)
- Remote control:
 - Monitoring of main measurements
 - Sending commands to products
- Reading alarms and events memory.

APP for smartphone and tablets

Sam1 (Setup And Maintenance 1) application allows the user to program the controller, view alarm conditions, send commands, read measurements, download statistical data and events and send retrieved data by email. The connection is made by Wi-Fi with a smartphone or tablet using CX02 dongle. It is iOS and Android compatible. For more details, consult Technical support; see contact details on inside front cover.

NFC App for RGK 4...SA, with integrated NFC technology, allows remote parameter configuration.

The parameters can be saved in a file for archive purposes. It is Android compatible. For more details, consult Technical support; see contact details on inside front cover.

ENGINE PROTECTION CONTROLLERS

RGK 30

Cutout

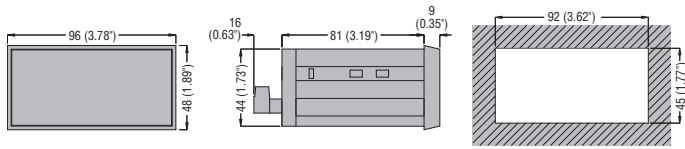

STAND-ALONE GEN-SET CONTROLLERS

RGK 400SA

RGK 420SA

Cutout

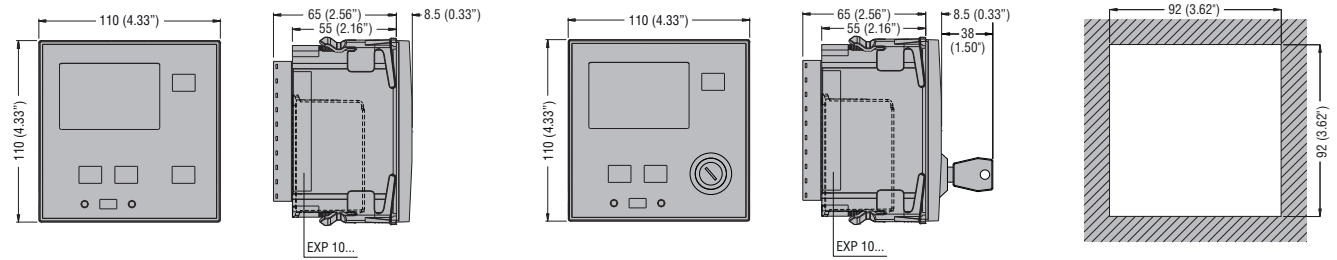

GEN-SET CONTROLLERS **RGK 600... - RGK 601... - RGK 610**

Cutout

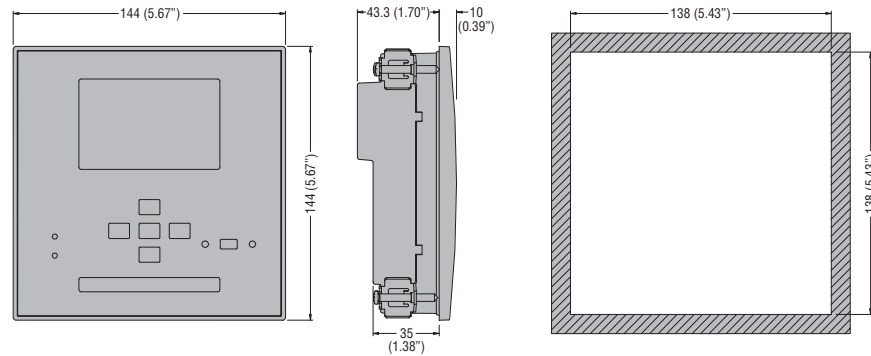

GEN-SET CONTROLLERS **RGK 700... - RGK 750... - RGK 800... - RGK 900...** - REMOTE DISPLAY PANELS **RGK 800RD - RGK 800RD SA - RGK 900RD - RGK 900RD SA**

Cutout

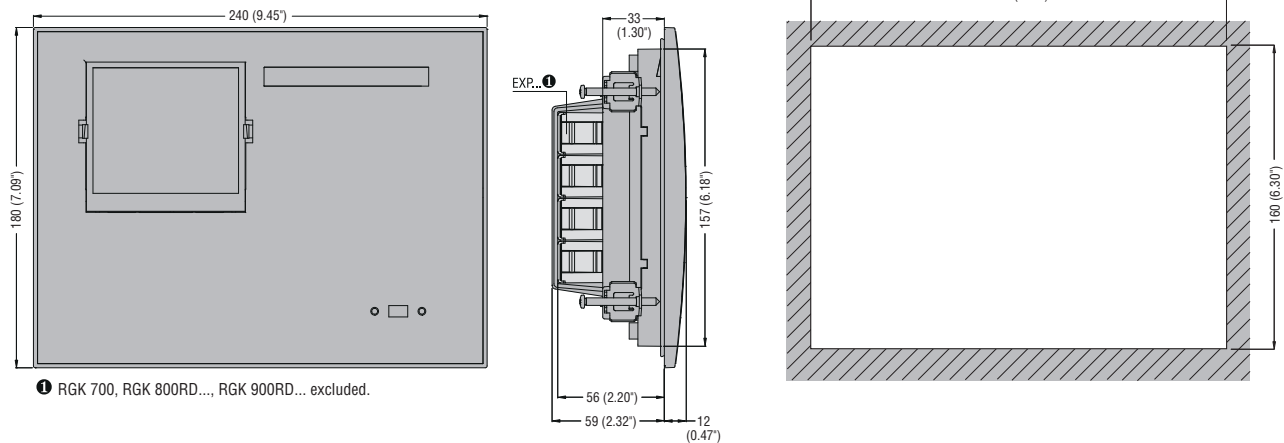

❶ RGK 700, RGK 800RD..., RGK 900RD... excluded.

REMOTE DISPLAY UNIT **RGK RA**

Cutout

ALARM-STATUS RELAY UNIT **RGK RR**

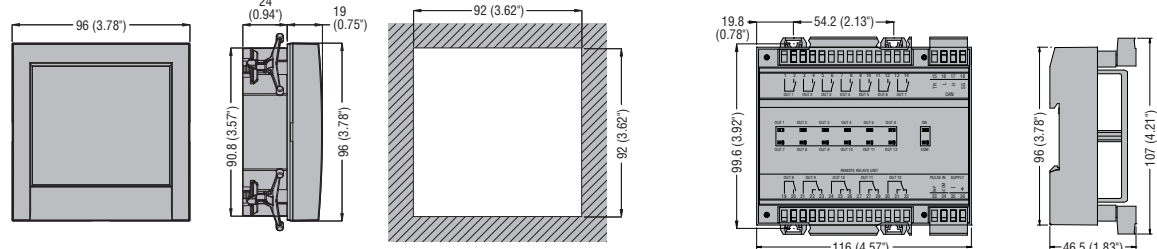



ENERGY AND AUTOMATION

www.LovatoElectric.com

LOVATO ELECTRIC S.P. A.

via Don E. Mazza, 12
24020 Gorle (Bergamo) Italy

Tel +39 035 4282111
info@LovatoElectric.com

Follow us



The products described in this publication are subject to be revised or improved at any moment. Catalogue descriptions and details, such as technical and operational data, drawings, diagrams and instructions, etc., do not have any contractual value. In addition, products should be installed and used by qualified personnel and in compliance with the regulations in force for electrical systems in order to avoid damages and safety hazards.