

MONOBLOCK ACTUATORS



 **Lovato**
electric

ENERGY AND AUTOMATION

MONOBLOCK ACTUATORS



HIGH DEGREE OF PROTECTION
IP66



SCREW AND SPRING TERMINALS

Versions with screw or spring terminals available for all kind of monoblock actuators.



QUICK AND EASY INSTALLATION

Actuator fixing on the mounting surface, through a Ø22mm drilled hole, is obtained using its threaded ring, easily rotated by hand or by socket spanner.

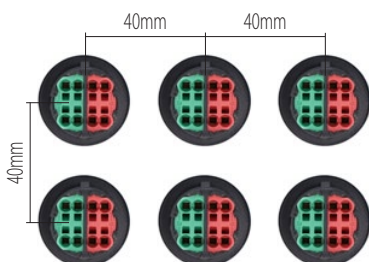

REDUCED DIMENSIONS AND INTERAXIS

cULus LISTED



All spring terminal monoblock actuator versions are cULus Listed.



LOW PROFILE AND COMPACT CONTACT BLOCK

The external actuator has a low profile and reduced front thickness. The contact block reduced dimensions integrate contacts and terminals in only 42mm.



ANTI-ROTATION FASTENER

This feature avoids actuator rotation and gives an orientation reference point for users during panel installation.



VIBRATIONS

Their monoblock construction assures outstanding stability, making them ideal for applications characterised by strong vibrations in which the risk of components detaching or breaking off is very high (e.g. power generation, railway equipment, etc.).

LONG ACTUATORS MECHANICAL LIFE

High performance characteristics assure a long mechanical life.



ACCESSORIES

Padlockable cover, disk for mushroom pushbuttons, shroud and label holders for any kind of installation need.

Pushbutton actuators, spring return



LMPB104T...



LMPB108T...



LMPB204T...



LMPB104S...



LMPB108S...



LMPB204S...

Pushbutton actuators, push-push



LMPQ102T11



LMPQ102S11

Order code	Colour	Contacts configuration	Qty per pkg.
SCREW TERMINALS			
Flush.			
LMPB104T01	Red	1NC	10
LMPB104T11	Red	1NO+1NC	10
LMPB104T02	Red	2NC	10
LMPB103T10	Green	1NO	10
LMPB103T11	Green	1NO+1NC	10
LMPB103T20	Green	2NO	10
LMPB108T10	White	1NO	10
LMPB108T11	White	1NO+1NC	10
LMPB108T20	White	2NO	10
LMPB102T01	Black	1NC	10
LMPB102T11	Black	1NO+1NC	10
LMPB102T02	Black	2NC	10
Extended.			
LMPB204T01	Red	1NC	10
LMPB204T11	Red	1NO+1NC	10
LMPB204T02	Red	2NC	10
SPRING TERMINALS			
Flush.			
LMPB104S01	Red	1NC	10
LMPB104S11	Red	1NO+1NC	10
LMPB104S02	Red	2NC	10
LMPB103S10	Green	1NO	10
LMPB103S11	Green	1NO+1NC	10
LMPB103S20	Green	2NO	10
LMPB108S10	White	1NO	10
LMPB108S11	White	1NO+1NC	10
LMPB108S20	White	2NO	10
LMPB102S01	Black	1NC	10
LMPB102S11	Black	1NO+1NC	10
LMPB102S02	Black	2NC	10
Extended.			
LMPB204S01	Red	1NC	10
LMPB204S11	Red	1NO+1NC	10
LMPB204S02	Red	2NC	10

Order code	Colour	Contacts configuration	Qty per pkg.
SCREW TERMINALS			
Flush. Push on-push off.			
LMPQ102T11	Black	1NO+1NC	10
SPRING TERMINALS			
Flush. Push on-push off.			
LMPQ102S11	Black	1NO+1NC	10



Operational characteristics

- Ambient conditions:
 - Operating temperature: -25...+70°C
 - Storage temperature: -40...+85°C
- Degree of protection:
 - Per IEC/EN: IP66 on front, IP20 on terminals
 - Per UL/CSA: Type 1, 4X indoor and 13 (only for spring terminal types)
- Maximum tightening torque for threaded fixing ring: 2Nm
- Conductor cross section range:
 - min: 0.2mm²/AWG26
 - max: 1.5mm²/AWG16.

General characteristics of contact elements

FOR SCREW TERMINALS

IEC rated insulation voltage: 300V

IEC rated thermal current I_{th}: 5A

IEC/EN 60947-5-1 designation: B300 R300

IEC/EN operational characteristics in AC12 category:

[V]	12	30	125	250
[A]	5	5	4	2

IEC/EN operational characteristics in AC15 category:

[V]	12	30	125	250
[A]	5	5	3	1.5

IEC/EN operational characteristics in DC12 category:

[V]	12	30	125	250
[A]	1	1	0.32	0.16

IEC/EN operational characteristics in DC13 category:

[V]	12	30	125	250
[A]	1	1	0.22	0.11

FOR SPRING TERMINALS

IEC rated insulation voltage: 400V

IEC rated thermal current I_{th}: 8A

IEC/EN 60947-5-1 designation: B300 R300

IEC/EN operational characteristics in AC12 category:

[V]	12	24	120	240	380
[A]	8	8	8	6	3.8

IEC/EN operational characteristics in AC15 category:

[V]	12	24	120	240	380
[A]	8	8	6	3	1.9

IEC/EN operational characteristics in DC12 category:

[V]	12	24	125	250	400
[A]	2.5	2.5	1.1	0.55	0.3

IEC/EN operational characteristics in DC13 category:

[V]	12	24	125	250	400
[A]	2.5	2.5	0.55	0.27	0.15

Spring return mechanical and electrical endurance

Mechanical life: 5.000.000 cycles (1.000.000 cycles for double contact spring terminal type)

Electrical life: 250.000 cycles (100.000 cycles for double contact spring terminal type).

Push-push mechanical and electrical endurance

Mechanical life: 250.000 cycles (400.000 cycles for single contact spring terminal type)

Electrical life: 250.000 cycles (100.000 cycles for double contact spring terminal type).

Certifications and compliance

Certifications obtained: cULus Listed for USA and Canada (only for spring terminal types).

Compliant with standards: IEC/EN 60947-1, IEC/EN 60947-5-1, UL508, CSA C22.2 n° 14.

Mushroom head pushbutton actuators



LMPB6144T11



LMPB6644T...



LMPB6744T...



LMPB6144T11



LMPB6644T...



LMPB6744T...

Order code	Colour	Contacts configuration	Qty per pkg.
SCREW TERMINALS Spring return. Ø40mm/1.6".			
LMPB6144T11	Red	1NO+1NC	10
Latch. Turn to release. Ø40mm/1.6". For emergency stopping, ISO 13850 compliant.			
LMPB6644T01	Red	1NC	10
LMPB6644T11	Red	1NO+1NC	10
LMPB6644T02	Red	2NC	10
Latch. Pull to release. Ø40mm/1.6". For emergency stopping, ISO 13850 compliant.			
LMPB6744T01	Red	1NC	10
LMPB6744T11	Red	1NO+1NC	10
LMPB6744T02	Red	2NC	10
SPRING TERMINALS Spring return. Ø40mm/1.6".			
LMPB6144S11	Red	1NO+1NC	10
Latch. Turn to release. Ø40mm/1.6". For emergency stopping, ISO 13850 compliant.			
LMPB6644S01	Red	1NC	10
LMPB6644S11	Red	1NO+1NC	10
LMPB6644S02	Red	2NC	10
Latch. Pull to release. Ø40mm/1.6". For emergency stopping, ISO 13850 compliant.			
LMPB6744S01	Red	1NC	10
LMPB6744S11	Red	1NO+1NC	10
LMPB6744S02	Red	2NC	10



Operational characteristics

- Ambient conditions:
 - Operating temperature: -25...+70°C
 - Storage temperature: -40...+85°C
- Degree of protection:
 - Per IEC/EN: IP66 on front, IP20 on terminals
 - Per UL/CSA: Type 1, 4X indoor and 13 (only for spring terminal types)
- Maximum tightening torque for threaded fixing ring: 2Nm
- Conductor cross section range:
 - min: 0.2mm²/AWG26
 - max: 1.5mm²/AWG16.

General characteristics of contact elements

FOR SCREW TERMINALS

IEC rated insulation voltage: 300V
IEC rated thermal current I_{th}: 5A
IEC/EN 60947-5-1 designation: B300 R300

IEC/EN operational characteristics in AC12 category:

[V]	12	30	125	250
[A]	5	5	4	2

IEC/EN operational characteristics in AC15 category:

[V]	12	30	125	250
[A]	5	5	3	1.5

IEC/EN operational characteristics in DC12 category:

[V]	12	30	125	250
[A]	1	1	0.32	0.16

IEC/EN operational characteristics in DC13 category:

[V]	12	30	125	250
[A]	1	1	0.22	0.11

FOR SPRING TERMINALS

IEC rated insulation voltage: 400V
IEC rated thermal current I_{th}: 8A
IEC/EN 60947-5-1 designation: B300 R300

IEC/EN operational characteristics in AC12 category:

[V]	12	24	120	240	380
[A]	8	8	8	6	3.8

IEC/EN operational characteristics in AC15 category:

[V]	12	24	120	240	380
[A]	8	8	6	3	1.9

IEC/EN operational characteristics in DC12 category:

[V]	12	24	125	250	400
[A]	2.5	2.5	1.1	0.55	0.3

IEC/EN operational characteristics in DC13 category:

[V]	12	24	125	250	400
[A]	2.5	2.5	0.55	0.27	0.15

Spring return mechanical and electrical endurance

Mechanical life:

- Spring return: 5.000.000 cycles (1.000.000 cycles for double contact spring terminal type)
- Latch: 250.000 cycles for screw terminal types; 300.000 cycles for spring terminal types.

Electrical life:

- Spring return: 250.000 cycles (100.000 cycles for double contact spring terminal type)
- Latch: 100.000 cycles.

Certifications and compliance

Certifications obtained: cULus Listed for USA and Canada (only for spring terminal types).

Compliant with standards: IEC/EN 60947-1, IEC/EN 60947-5-1, UL508, CSA C22.2 n° 14.

Selector switch actuators lever



LMPS120T...



LMPS13...T20



LMPS120S...



LMPS13...S20

Selector switch actuators key



LMPS3...T...



LMPS3...S...



LMPK00

Order code	Type of position	Contacts configuration	Qty per pkg.
SCREW TERMINALS			
2 positions.			
LMPS120T10	0-1	1NO	10
LMPS120T11	0-1	1NO+1NC	10
LMPS120T20	0-1	2NO	10
3 positions.			
LMPS130T20	1-0-2	2NO	10
LMPS131T20	1>0<2	2NO	10
SPRING TERMINALS			
2 positions.			
LMPS120S10	0-1	1NO	10
LMPS120S11	0-1	1NO+1NC	10
LMPS120S20	0-1	2NO	10
3 positions.			
LMPS130S20	1-0-2	2NO	10
LMPS131S20	1>0<2	2NO	10

Order code	Type of position	Contacts configuration	Qty per pkg.
SCREW TERMINALS			
2 positions.			
LMPS320T10	0-1	1NO	10
3 positions.			
LMPS330T20	1-0-2	2NO	10
SPRING TERMINALS			
2 positions.			
LMPS320S10	0-1	1NO	10
3 positions.			
LMPS330S20	1-0-2	2NO	10
ACCESSORIES			
LMPK00	Spare key set (2 pcs.) for selector switch actuators key		1



Operational characteristics

- Ambient conditions:
 - Operating temperature: -25...+70°C
 - Storage temperature: -40...+85°C
- Degree of protection:
 - Per IEC/EN: IP66 on front for lever types, IP65 on front for key types, IP20 on terminals
 - Per UL/CSA: Type 1, 4X indoor and 13 (only for spring terminal types)
- Maximum tightening torque for threaded fixing ring: 2Nm
- Conductor cross section range:
 - min: 0.2mm²/AWG26
 - max: 1.5mm²/AWG16.

General characteristics of contact elements

FOR SCREW TERMINALS

IEC rated insulation voltage: 300V

IEC rated thermal current I_{th}: 5A

IEC/EN 60947-5-1 designation: B300 R300

IEC/EN operational characteristics in AC12 category:

[V]	12	30	125	250
[A]	5	5	4	2

IEC/EN operational characteristics in AC15 category:

[V]	12	30	125	250
[A]	5	5	3	1.5

IEC/EN operational characteristics in DC12 category:

[V]	12	30	125	250
[A]	1	1	0.32	0.16

IEC/EN operational characteristics in DC13 category:

[V]	12	30	125	250
[A]	1	1	0.22	0.11

FOR SPRING TERMINALS

IEC rated insulation voltage: 400V

IEC rated thermal current I_{th}: 8A

IEC/EN 60947-5-1 designation: B300 R300

IEC/EN operational characteristics in AC12 category:

[V]	12	24	120	240	380
[A]	8	8	8	6	3.8

IEC/EN operational characteristics in AC15 category:

[V]	12	24	120	240	380
[A]	8	8	6	3	1.9

IEC/EN operational characteristics in DC12 category:

[V]	12	24	125	250	400
[A]	2.5	2.5	1.1	0.55	0.3

IEC/EN operational characteristics in DC13 category:

[V]	12	24	125	250	400
[A]	2.5	2.5	0.55	0.27	0.15

Mechanical and electrical endurance

Mechanical life: 250.000 cycles (400.000 cycles for single contact spring terminal type)

Electrical life: 250.000 cycles (100.000 cycles for double contact spring terminal type).

Type of position

- Maintained position.
- Instable position.
- Key extraction position.

Rotation angle

2 position



3 position



Certifications and compliance

Certifications obtained: cULus Listed for USA and Canada (only for spring terminal types).

Compliant with standards: IEC/EN 60947-1, IEC/EN 60947-5-1, UL508, CSA C22.2 n° 14.

MONOBLOCK ACTUATORS

Illuminated pushbutton actuator, spring return



LMPBL104S...



LMPBL103S...



LMPBL204T01...



LMPBL104S...



LMPBL103S...



LMPBL204S01...

Order code	Colour	Voltage	Contacts config.	Qty per pkg.
SCREW TERMINALS				
Flush.				
LMPBL104T01B	Red	24VAC/DC	1NC	10
LMPBL103T10B	Green		1NO	10
LMPBL107T10B	Transp.		1NO	10
LMPBL104T01E	Red	110VAC	1NC	10
LMPBL103T10E	Green		1NO	10
LMPBL107T10E	Transp.		1NO	10
LMPBL104T01M	Red	220VAC	1NC	10
LMPBL103T10M	Green		1NO	10
LMPBL107T10M	Transp.		1NO	10
Extended.				
LMPBL204T01B	Red	24VAC/DC	1NC	10
LMPBL204T01E	Red	110VAC	1NC	10
LMPBL204T01M	Red	220VAC	1NC	10
SPRING TERMINALS				
Flush.				
LMPBL104S01B	Red	24VAC/DC	1NC	10
LMPBL103S10B	Green		1NO	10
LMPBL107S10B	Transp.		1NO	10
LMPBL104S01E	Red	110VAC	1NC	10
LMPBL103S10E	Green		1NO	10
LMPBL107S10E	Transp.		1NO	10
LMPBL104S01M	Red	220VAC	1NC	10
LMPBL103S10M	Green		1NO	10
LMPBL107S10M	Transp.		1NO	10
Extended.				
LMPBL204S01B	Red	24VAC/DC	1NC	10
LMPBL204S01E	Red	110VAC	1NC	10
LMPBL204S01M	Red	220VAC	1NC	10



Accessories



LMXAU158



LMXAU115



LMXAU159



LMXAU160



LPXA102



LPXA130

Order code	Description	Qty per pkg.
LMXAU158	Padlockable protection, Ø7mm max. for pushbuttons and selector switches	1
LMXAU115	Plastic disk for mushroom head pushbuttons "EMERGENCY-STOP"	1
LMXAU159	Shroud for mushroom pushbuttons, total cover	1
LMXAU160	Shroud for mushroom pushbuttons, half cover	1
LPXA102	Legend holder	50
LPXA201	Blank plastic label for engraving	50
LPXA202	Blank paper label for writing	50
LPXA200	Transparent protection for LPXA202 label	50
LPXA130	Threaded plug for unused drilled holes (grey)	50
LPXA130B	Threaded plug for unused drilled holes (black)	50
LPXA200	Socket spanner/wrench for fixing ring fitting	1

Operational characteristics

- Ambient conditions:
 - Operating temperature: -25...+55°C
 - Storage temperature: -40...+85°C
- Degree of protection:
 - Per IEC/EN: IP66 on front, IP20 on terminals
 - Per UL/CSA: Type 1, 4X indoor and 13 (only for spring terminal types)
- Maximum tightening torque for threaded fixing ring: 2Nm
- Conductor cross section range:
 - min: 0.2mm²/AWG26
 - max: 1.5mm²/AWG16.

LED lamp ratings

- Rated current:
- 24V: 10mA (red); 2.2mA (green); 4.5mA (trasp.)
 - 110V: 10.6mA (red); 2.8mA (green); 6mA (trasp.)
 - 220V: 10.5mA (red); 1.9mA (green); 4.6mA (trasp.).

General characteristics of contact elements

FOR SCREW TERMINALS

- IEC rated insulation voltage: 300V
- IEC rated thermal current I_{th}: 5A
- IEC/EN 60947-5-1 designation: B300 R300

IEC/EN operational characteristics in AC12 category:

[V]	12	30	125	250
[A]	5	5	4	2

IEC/EN operational characteristics in AC15 category:

[V]	12	30	125	250
[A]	5	5	3	1.5

IEC/EN operational characteristics in DC12 category:

[V]	12	30	125	250
[A]	1	1	0.32	0.16

IEC/EN operational characteristics in DC13 category:

[V]	12	30	125	250
[A]	1	1	0.22	0.11

FOR SPRING TERMINALS

- IEC rated insulation voltage: 400V
- IEC rated thermal current I_{th}: 8A
- IEC/EN 60947-5-1 designation: B300 R300

IEC/EN operational characteristics in AC12 category:

[V]	12	24	120	240	380
[A]	8	8	8	6	3.8

IEC/EN operational characteristics in AC15 category:

[V]	12	24	120	240	380
[A]	8	8	6	3	1.9

IEC/EN operational characteristics in DC12 category:

[V]	12	24	125	250	400
[A]	2.5	2.5	1.1	0.55	0.3

IEC/EN operational characteristics in DC13 category:

[V]	12	24	125	250	400
[A]	2.5	2.5	0.55	0.27	0.15

Mechanical and electrical endurance

- Mechanical life: 5.000.000 cycles (1.000.000 cycles for double contact spring terminal type)
- Electrical life: 250.000 cycles (100.000 cycles for double contact spring terminal type).

Certifications and compliance

- Certifications obtained: cULus Listed for USA and Canada (only for spring terminal types).
- Compliant with standards: IEC/EN 60947-1, IEC/EN 60947-5-1, UL508, CSA C22.2 n° 14.

Dimensions [mm]

Flush pushbutton actuator, spring return and push-push

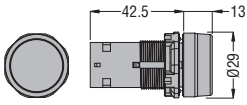

Extended pushbutton actuator, spring return

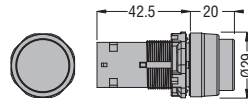

Mushroom head actuator, spring return

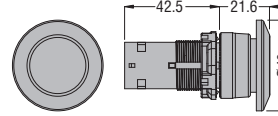

Mushroom head actuator, latch return

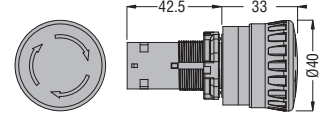

Selector switch actuators lever

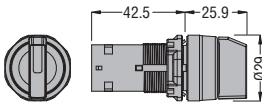

Selector switch actuators key

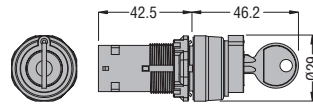

Illuminated flush pushbutton actuator, spring return

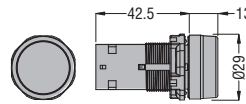

Illuminated extended pushbutton actuator, spring return

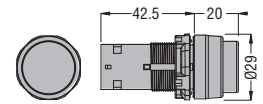

Padlockable protection cover for pushbuttons and selector switch actuator lever

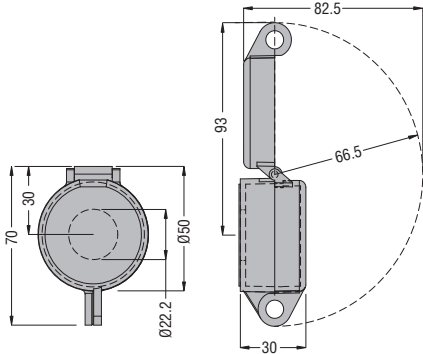

Plastic disk for mushroom head

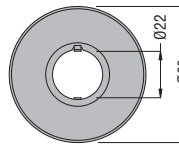

Shroud for mushroom head pushbuttons, total cover

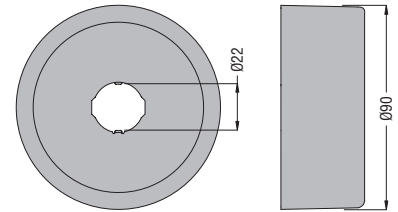

Shroud for mushroom head pushbuttons, half cover

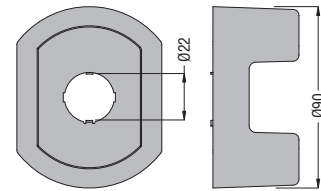

Legend holder

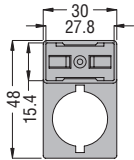

Labels

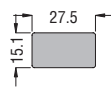

Threaded plug for unused drilled holes

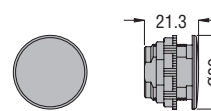

Mounting holes layout [mm]

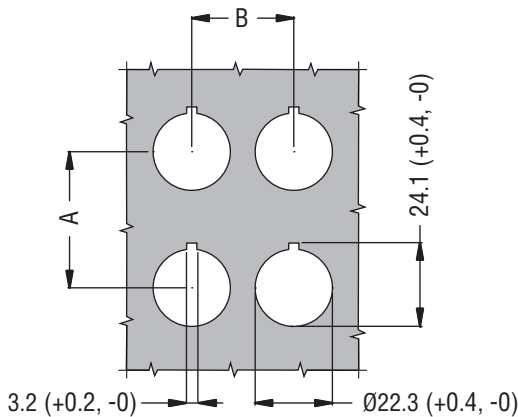

	A [mm]	B [mm]
Pushbuttons		
Selector switches	>30	>40
Key selector switches		
Mushroom pushbuttons	>50	>50
Emergency stop switches	>40	>40

NOTE:

- Keep a minimum spacing of 50mm when using an illuminated pushbutton
- Panel thickness 0.8...12mm.

MONOBLOCK ACTUATORS



ENERGY AND AUTOMATION

www.LovatoElectric.com

LOVATO ELECTRIC S.P. A.

via Don E. Mazza, 12
24020 Gorle (Bergamo), ITALY

tel +39 035 4282111
info@LovatoElectric.com



- **LOVATO ELECTRIC S.P.A.**
ITALY
www.LovatoElectric.com
- **LOVATO ELECTRIC LTD**
UNITED KINGDOM
www.Lovato.co.uk
- **LOVATO ELECTRIC CORPORATION**
CANADA
www.Lovato.ca
- **LOVATO ELECTRIC INC**
UNITED STATES
www.LovatoUsa.com
- **LOVATO ELECTRIC GmbH**
GERMANY
www.LovatoElectric.de
- **LOVATO ELECTRIC S.L.U**
SPAIN
www.LovatoElectric.es
- **LOVATO ELECTRIC. S.R.O.**
CZECH REPUBLIC
www.LovatoElectric.cz
- **LOVATO ELECTRIC SP. Z O.O.**
POLAND
www.LovatoElectric.pl
- **LOVATO ELEKTRIK LTD**
TURKEY
www.LovatoElectric.com.tr
- **LOVATO ELECTRIC ME FZE**
UNITED ARAB EMIRATES
www.LovatoElectric.ae
- **ООО Ловато Электрик**
RUSSIA
www.LovatoElectric.ru
- **LOVATO ELECTRIC CO LTD**
CHINA
www.LovatoElectric.cn
- **LOVATO ELECTRIC SRL**
ROMANIA
www.LovatoElectric.ro
- **LOVATO ELECTRIC SAS**
FRANCE
www.LovatoElectric.fr
- **LOVATO ELECTRIC AG**
SWITZERLAND
www.LovatoElectric.ch
- **LOVATO KONČAR d.o.o.**
CROAZIA
www.LovatoElectric.hr