

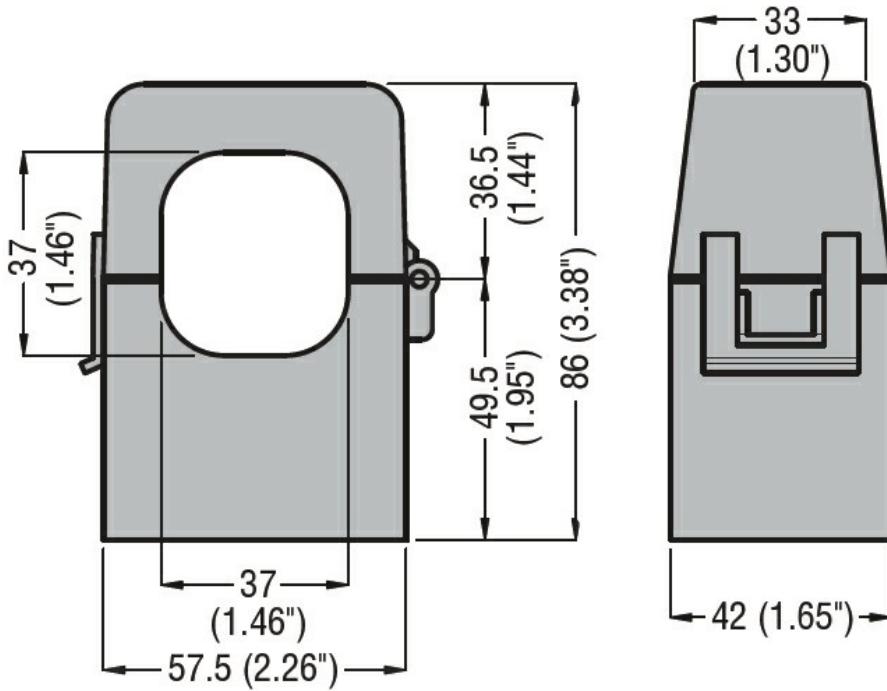

Product designation				Current transformers
Product type designation				DM2TMA0400
Type of CT				Split-core
<b>Current inputs</b>				
Primary current I <sub>pn</sub> (/5)			A	400
Operational frequency	min	Hz	50	
	max	Hz	60	
Secondary output current			A	5
Overload withstand I <sub>pn</sub>			%	120
Burden	cl. 0.5	VA	0.5	
	cl. 1	VA	1.5	
<b>Insulations</b>				
Rated insulation voltage U <sub>i</sub> IEC/EN			V	720
IEC rated short-time thermal current I <sub>th</sub>			I <sub>th</sub> for s	40...60
IEC rated dynamic current I <sub>dyn</sub>			I <sub>th</sub> for s	2.5
Insulation dry type				Class E
<b>Mechanical features</b>				
Terminals type				2m pre-wired
Weight			g	380
<b>Ambient conditions</b>				
Temperature	Operating temperature	min	°C	-25
		max	°C	+50
Storage temperature		min	°C	-40
		max	°C	+80
Relative humidity			%	90
<b>Dimensions</b>				



**Certifications and compliance**

Certifications

IEC/EN/BS 61869-1

IEC/EN/BS 61869-2

Compliance

EAC

**ETIM classification**

EC000066 - Power contactor, AC switching