

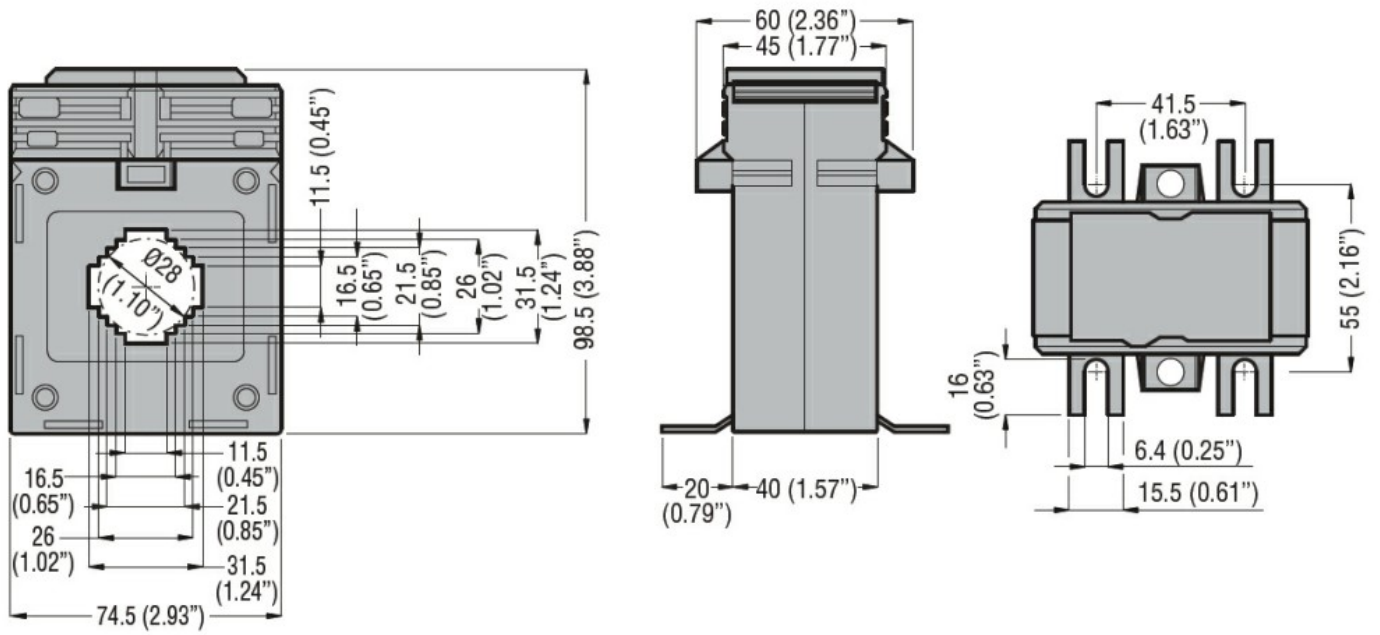

Product designation				Current transformers
Product type designation				DM1TP0200
Type of CT				Solid-core
<b>Current inputs</b>				
Primary current I <sub>pn</sub> (/5)			A	200
Operational frequency	min	Hz	50	
	max	Hz	60	
Secondary output current			A	5
Overload withstand I <sub>pn</sub>			%	120
Burden	cl. 0.5s	VA	2.5	
	cl. 0.5	VA	3.75	
<b>Insulations</b>				
Rated insulation voltage U <sub>i</sub> IEC/EN			V	720
IEC rated short-time thermal current I <sub>th</sub>			I <sub>th</sub> for s	40...60
IEC rated dynamic current I <sub>dyn</sub>			I <sub>th</sub> for s	2.5
Insulation dry type				Class E
<b>Mechanical features</b>				
Terminals type				Screw
Fixing				DIN rail or by Screw
Weight			g	480
<b>Ambient conditions</b>				
Temperature	Operating temperature	min	°C	-25
		max	°C	+50
	Storage temperature	min	°C	-40
		max	°C	+80
Relative humidity			%	90
Protection degree				IP30
<b>Dimensions</b>				



**Certifications and compliance**

Certifications

IEC/EN/BS 61869-1

IEC/EN/BS 61869-2

Compliance

EAC

**ETIM classification**

EC000066 - Power contactor, AC switching