

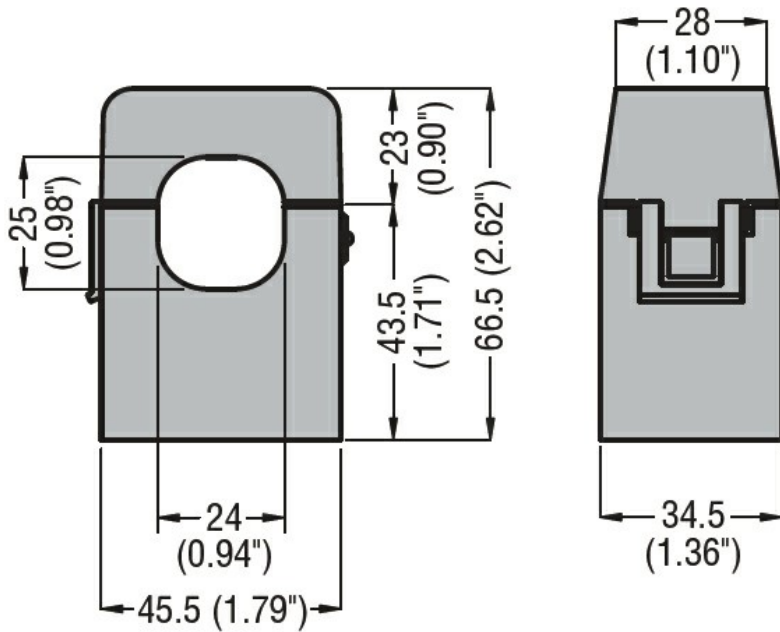

Product designation	Current transformers		
Product type designation	DM1TMA0200		
Type of CT	Split-core		
Current inputs			
Primary current I _{pn} (/5)	A	200	
Operational frequency	min	Hz	50
	max	Hz	60
Secondary output current	A	5	
Overload withstand I _{pn}	%	120	
Burden	cl. 1	VA	1
Insulations			
Rated insulation voltage U _i IEC/EN	V	720	
IEC rated short-time thermal current I _{th}	I _{th} for s	40...60	
IEC rated dynamic current I _{dyn}	I _{th} for s	2.5	
Insulation dry type	Class E		
Mechanical features			
Terminals type	2m pre-wired		
Weight	g	200	
Ambient conditions			
Temperature	Operating temperature		
	min	°C	-25
	max	°C	+50
	Storage temperature		
	min	°C	-40
	max	°C	+80
Relative humidity	%	90	
Dimensions			



Certifications and compliance

Certifications

IEC/EN/BS 61869-1

IEC/EN/BS 61869-2

Compliance

EAC

ETIM classification

EC000066 - Power contactor, AC switching